

PART NUMBER	DESCRIPTION
CCR-48K	Commercial Normally Open Multi-throw, DC-40GHz
CR-48K	Elite Normally Open Multi-throw, DC-40GHz

The CCR-48K/CR-48K is a broadband, multi-throw, electromechanical coaxial switch designed to switch a microwave signal from a common input to any of 3, 4, 5, or 6 outputs. The characteristic impedance is 50 Ohms. The switches are small using the popular connector spacing on a 1.062" dia. circle. Each position has an individual actuator mechanism allowing random position selection. This also gives the minimum switching time.
With the normally open actuator, all paths are open when the switch is de-energized.



Available with
USB & Ethernet
Control!



ENVIRONMENTAL AND PHYSICAL CHARACTERISTICS	
Operating Temperature	
Commercial Model, CCR-48K	-25°C to 65°C
Elite Model, CR-48K	-55°C to 85°C
Vibration (MIL-STD-202 Method 214, Condition D, non-operating)	10 g's RMS
Shock (MIL-STD-202 Method 213, Condition D, non-operating)	500 g's
Standard Actuator Life	5,000,000 cycles
Actuator Life w/ Additional Features	1,000,000 cycles
Connector Type	2.92 mm (K)
Humidity (Moisture Seal)	Available
Weight	6 oz. (170.1g) (max.)

ELECTRICAL CHARACTERISTICS	
Form Factor	Multi-Throw, break before make
Frequency Range	
CCR-48K	DC-40 GHz
CR-48K	DC-40 GHz
Characteristic Impedance	50 Ohms
Operate Time	15 ms (max.)
Release Time	15 ms (max.)
Actuation Voltage Available	12 15 24 28 V
Actuation Current, max. @ ambient	400 205 170 140 mA

PERFORMANCE CHARACTERISTICS						
Frequency	DC-6 GHz	6-12 GHz	12-18 GHz	18-27 GHz	27-34 GHz	34-40 GHz
Insertion Loss, dB, max.	0.2	0.4	0.5	0.9	1.0	1.5
Isolation, dB, min.	70	60	60	50	50	50
VSWR, max.	1.25:1	1.40:1	1.50:1	1.80:1	1.90:1	2.1:1

PART NUMBERING SYSTEM

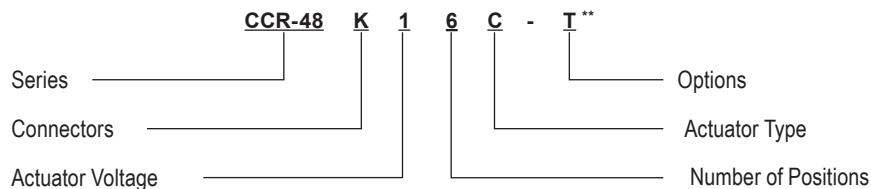

CONNECTOR	ACTUATOR VOLTAGE	NUMBER OF POSITIONS	ACTUATOR TYPE	OPTIONS
K: 2.92mm FEMALE	1: 28 VDC NORMALLY OPEN	3: SP3T	0: NO INDICATOR CONTACTS	T: TTL DRIVERS WITH DIODES
	2: 15 VDC NORMALLY OPEN	4: SP4T	C: INDICATOR CONTACTS***	D: COIL TRANSIENT SUPPRESSION DIODES
	3: 12 VDC NORMALLY OPEN	5: SP5T		S: D-SUB CONNECTOR*
	4: 24 VDC NORMALLY OPEN	6: SP6T		M: MOISTURE SEAL

**SEE PARTS LIST ON PAGE 12-13

***Indicator Contacts Operating Temperature
-50°C to 85°C (Elite Model Only)

* D-Sub Connector may be 9 or 15 pin depending on number of throws. (See Connector Pinout page)

For additional options, please contact factory.

Series CCR-48K/CR-48K

Multi-Throw DC-40 GHz
Normally Open Coaxial Switch



SCHEMATICS AND MECHANICAL OUTLINE

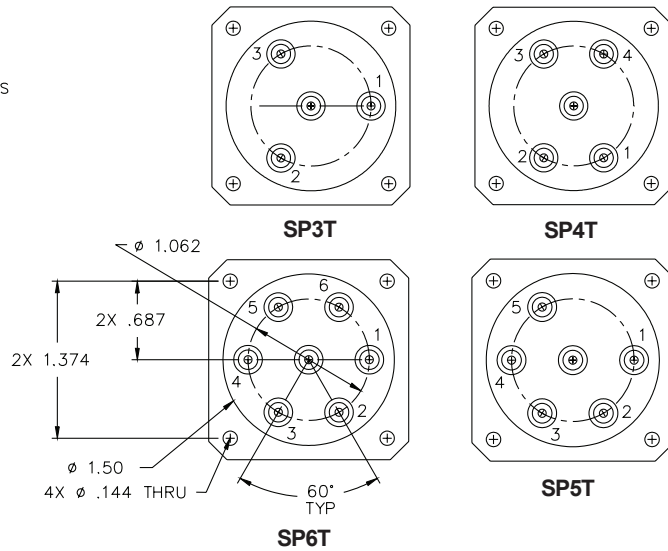
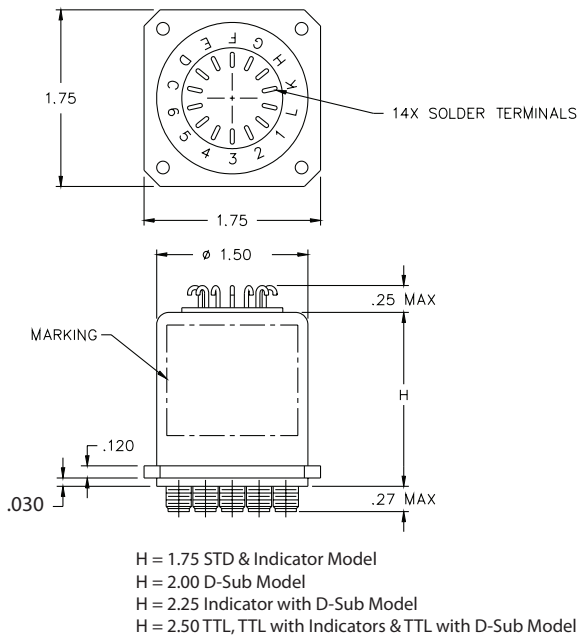
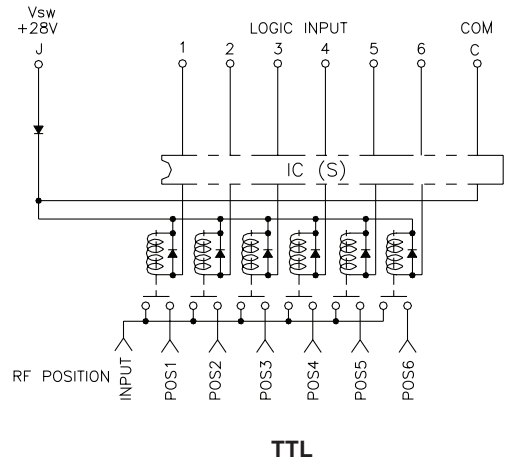
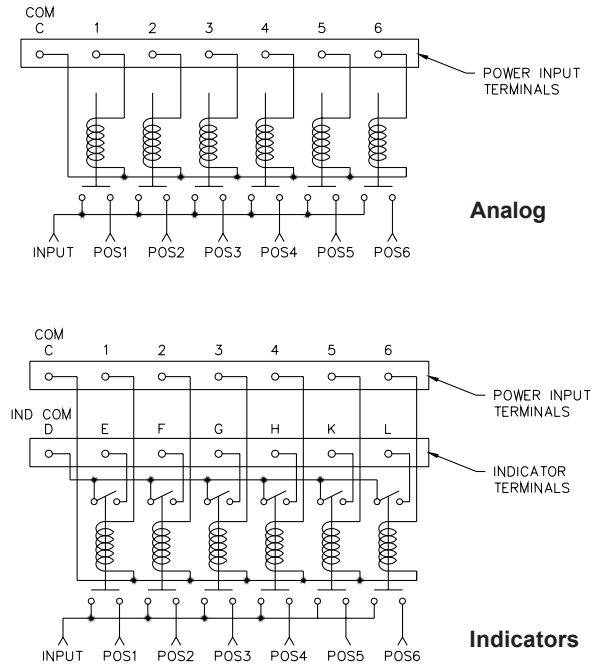

“-S OPTION” 9-PIN D-SUB OR 15-PIN D-MICRO CONNECTOR (EXAMPLE: CCR-48K160-S)

CONNECTOR PINOUT FOR NORMALLY OPEN SP3T MULTI-THROW SWITCHES				
EXAMPLE	CR-48K130-S	CR-48K13C-S	CR-48K130-TS	CR-48K13C-TS
INDICATOR		YES		YES
TTL			YES	YES
DECODERS & TTL				
PIN NO.	9-PIN	9-PIN	9-PIN	9-PIN
1	PORT 1	PORT 1	PORT 1	TTL 1
2	PORT 2	PORT 2	PORT 2	TTL 2
3	PORT 3	PORT 3	PORT 3	TTL 3
4		E INDICATOR		E INDICATOR
5		F INDICATOR		F INDICATOR
6		G INDICATOR		G INDICATOR
7	COMMON	COMMON	COMMON	COMMON
8			VSW	VSW
9		D INDICATOR (COM)		D INDICATOR (COM)

CONNECTOR PINOUT FOR NORMALLY OPEN SP4T MULTI-THROW SWITCHES				
EXAMPLE	CR-48K140-S	CR-48K14C-S	CR-48K140-TS	CR-48K14C-TS
INDICATOR		YES		YES
TTL			YES	YES
DECODERS & TTL				
PIN NO.	9-PIN	15-PIN	9-PIN	15-PIN
1	PORT 1	PORT 1	TTL 1	TTL 1
2	PORT 2	PORT 2	TTL 2	TTL 2
3	PORT 3	PORT 3	TTL 3	TTL 3
4	PORT 4	PORT 4	TTL 4	TTL 4
5				
6				
7	COMMON	COMMON	COMMON	COMMON
8			VSW	VSW
9		D INDICATOR (COM)		D INDICATOR (COM)
10	N/A	E INDICATOR	N/A	E INDICATOR
11		F INDICATOR		F INDICATOR
12		G INDICATOR		G INDICATOR
13		H INDICATOR		H INDICATOR
14				
15				

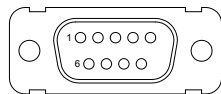

9-PIN D-SUB CONNECTOR

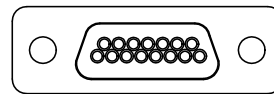

15-PIN D-MICRO CONNECTOR

Series CCR-48K/CR-48K
Multi-Throw DC-40 GHz
Normally Open Coaxial Switch



CONNECTOR PINOUT FOR NORMALLY OPEN SP5T MULTI-THROW SWITCHES				
EXAMPLE	CR-48K150-S	CR-48K15C-S	CR-48K150-TS	CR-48K15C-TS
INDICATOR		YES		YES
TTL			YES	YES
DECODERS & TTL				
PIN NO.	9-PIN	15-PIN	9-PIN	15-PIN
1	PORT 1	PORT 1	TTL 1	TTL 1
2	PORT 2	PORT 2	TTL 2	TTL 2
3	PORT 3	PORT 3	TTL 3	TTL 3
4	PORT 4	PORT 4	TTL 4	TTL 4
5	PORT 5	PORT 5	TTL 5	TTL 5
6				
7	COMMON	COMMON	COMMON	COMMON
8			VSW	VSW
9		D INDICATOR (COM)		D INDICATOR (COM)
10	N/A	E INDICATOR	N/A	E INDICATOR
11		F INDICATOR		F INDICATOR
12		G INDICATOR		G INDICATOR
13		H INDICATOR		H INDICATOR
14		K INDICATOR		K INDICATOR
15				

CONNECTOR PINOUT FOR NORMALLY OPEN SP6T MULTI-THROW SWITCHES				
EXAMPLE	CR-48K160-S	CR-48K16C-S	CR-48K160-TS	CR-48K16C-TS
INDICATOR		YES		YES
TTL			YES	YES
DECODERS & TTL				
PIN NO.	9-PIN	15-PIN	9-PIN	15-PIN
1	PORT 1	PORT 1	TTL 1	TTL 1
2	PORT 2	PORT 2	TTL 2	TTL 2
3	PORT 3	PORT 3	TTL 3	TTL 3
4	PORT 4	PORT 4	TTL 4	TTL 4
5	PORT 5	PORT 5	TTL 5	TTL 5
6	PORT 6	PORT 6	TTL 6	TTL 6
7	COMMON	COMMON	COMMON	COMMON
8			VSW	VSW
9		D INDICATOR (COM)		D INDICATOR (COM)
10	N/A	E INDICATOR	N/A	E INDICATOR
11		F INDICATOR		F INDICATOR
12		G INDICATOR		G INDICATOR
13		H INDICATOR		H INDICATOR
14		K INDICATOR		K INDICATOR
15		L INDICATOR		L INDICATOR

TRUTH TABLE Normally Open
CCR-48KX3C-T

Logic Input			RF Path			Indicator Switches		
1	2	3	J1	J2	J3	E	F	G
1	0	0	On	Off	Off	C	0	0
0	1	0	Off	On	Off	0	C	0
0	0	1	Off	Off	On	0	0	C

TRUTH TABLE Normally Open
CCR-48KX4C-T

Logic Input				RF Path				Indicator Switches			
1	2	3	4	J1	J2	J3	J4	E	F	G	H
1	0	0	0	On	Off	Off	Off	C	0	0	0
0	1	0	0	Off	On	Off	Off	0	C	0	0
0	0	1	0	Off	Off	On	Off	0	0	C	0
0	0	0	1	Off	Off	Off	On	0	0	0	C

TRUTH TABLE Normally Open
CCR-48KX5C-T

Logic Input					RF Path					Indicator Switches				
1	2	3	4	5	J1	J2	J3	J4	J5	E	F	G	H	K
1	0	0	0	0	On	Off	Off	Off	Off	C	0	0	0	0
0	1	0	0	0	Off	On	Off	Off	Off	0	C	0	0	0
0	0	1	0	0	Off	Off	On	Off	Off	0	0	C	0	0
0	0	0	1	0	Off	Off	Off	On	Off	0	0	0	C	0
0	0	0	0	1	Off	Off	Off	Off	On	0	0	0	0	C

TRUTH TABLE Normally Open
CCR-48KX6C-T

Logic Input						RF Path						Indicator Switches					
1	2	3	4	5	6	J1	J2	J3	J4	J5	J6	E	F	G	H	K	L
1	0	0	0	0	0	On	Off	Off	Off	Off	Off	C	0	0	0	0	0
0	1	0	0	0	0	Off	On	Off	Off	Off	Off	0	C	0	0	0	0
0	0	1	0	0	0	Off	Off	On	Off	Off	Off	0	0	C	0	0	0
0	0	0	1	0	0	Off	Off	Off	On	Off	Off	0	0	0	C	0	0
0	0	0	0	1	0	Off	Off	Off	Off	On	Off	0	0	0	0	C	0
0	0	0	0	0	1	Off	Off	Off	Off	Off	On	0	0	0	0	0	C

TYPICAL NARROWBAND RF INSERTION LOSS PERFORMANCE CURVES

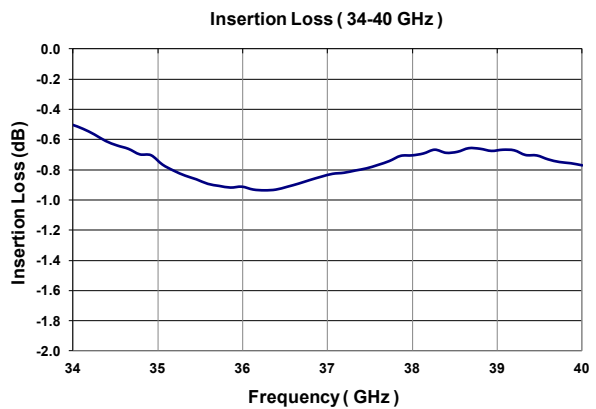
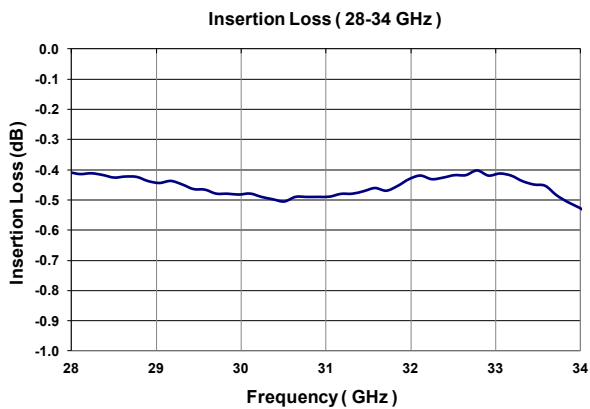
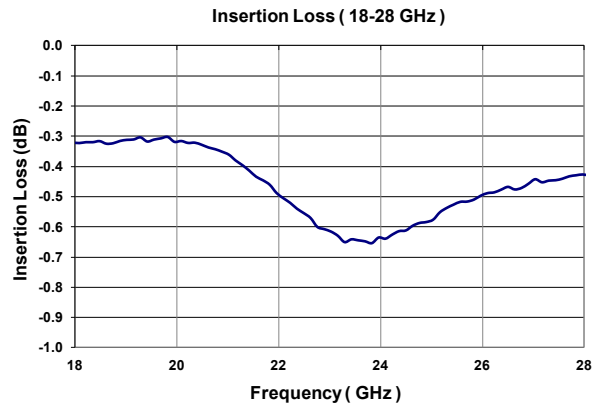
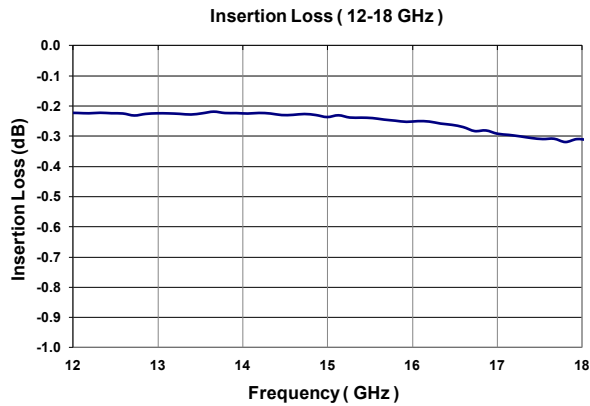
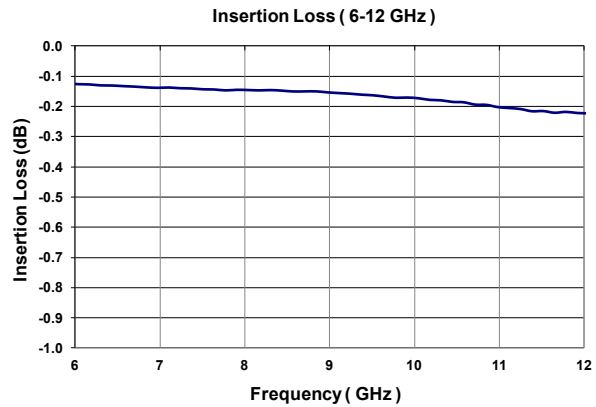
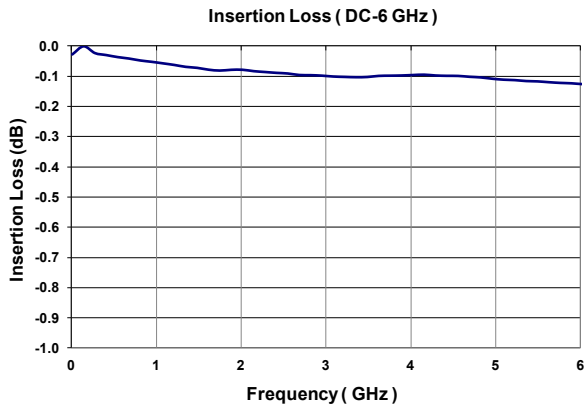

18GHz+ ELITE MODEL ONLY

RF NOTES

[Empty box for RF notes]

TYPICAL NARROWBAND RF ISOLATION PERFORMANCE CURVES

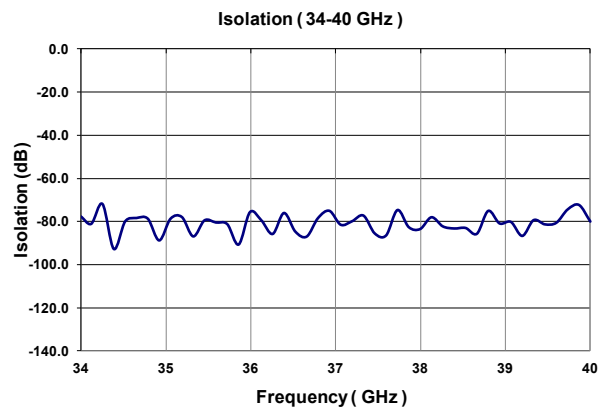
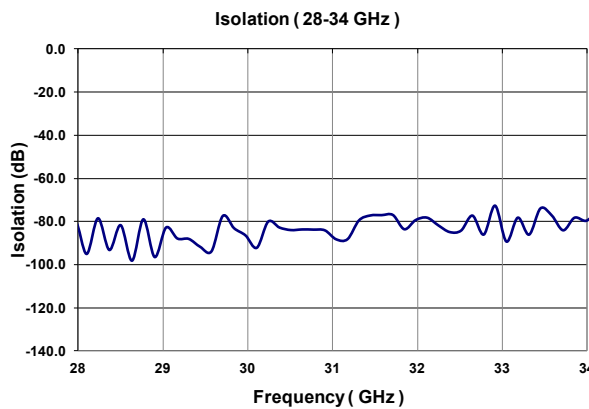
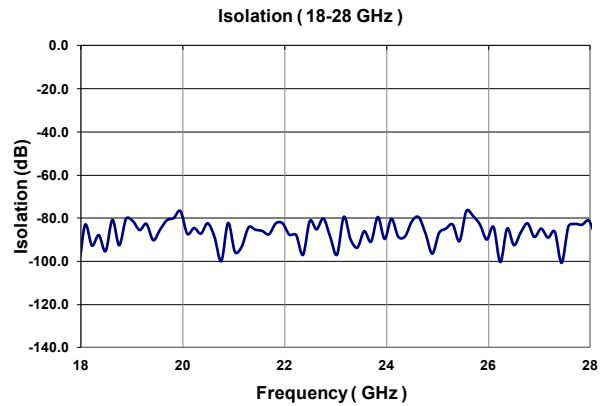
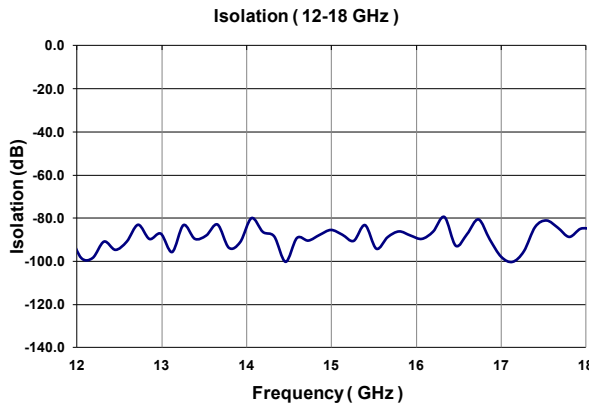
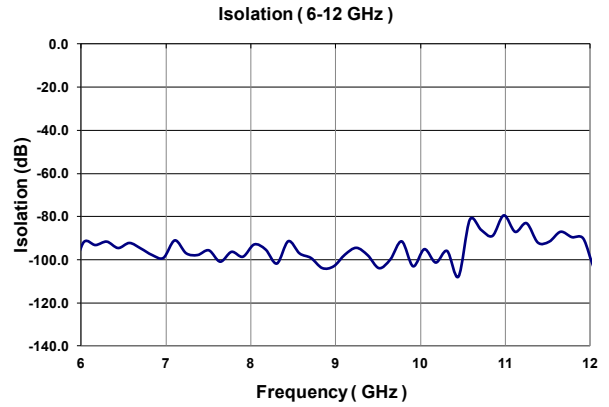
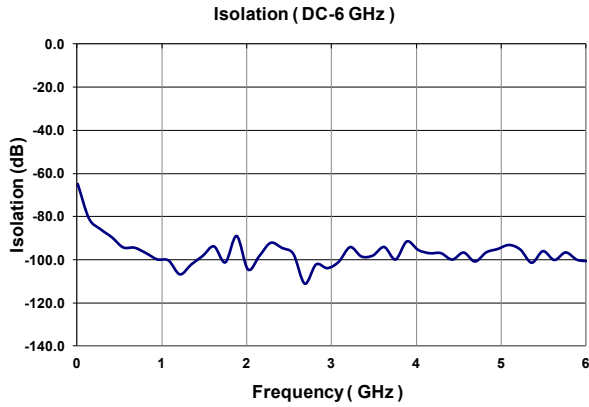

18GHz+ ELITE MODEL ONLY

RF NOTES

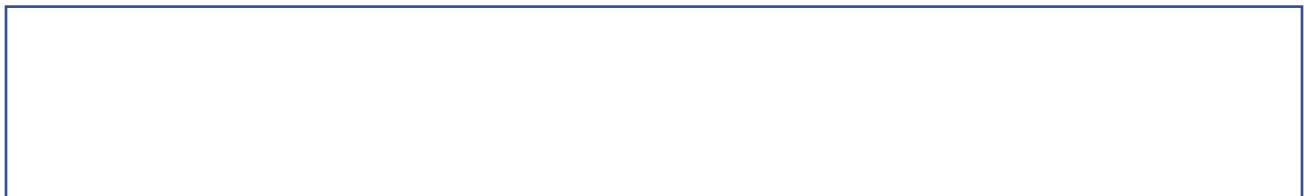

TYPICAL NARROWBAND RF VSWR PERFORMANCE CURVES

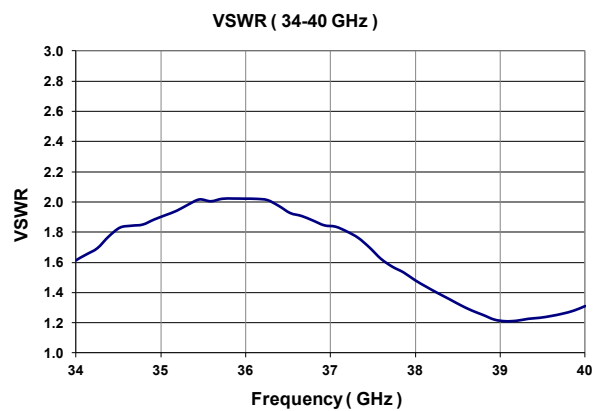
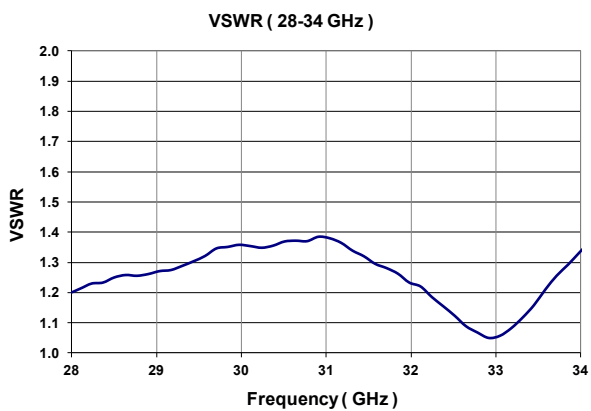
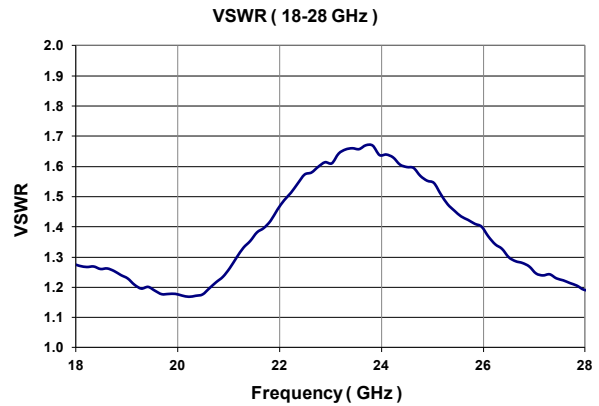
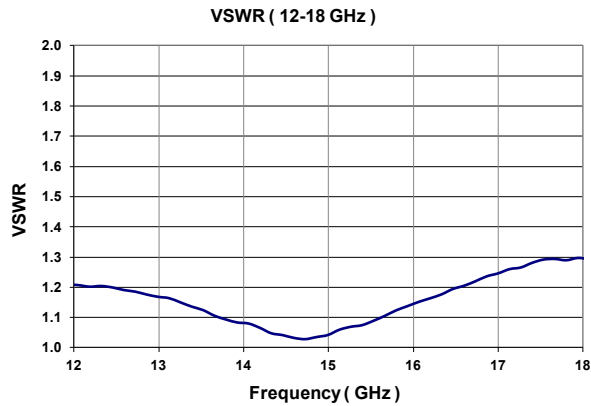
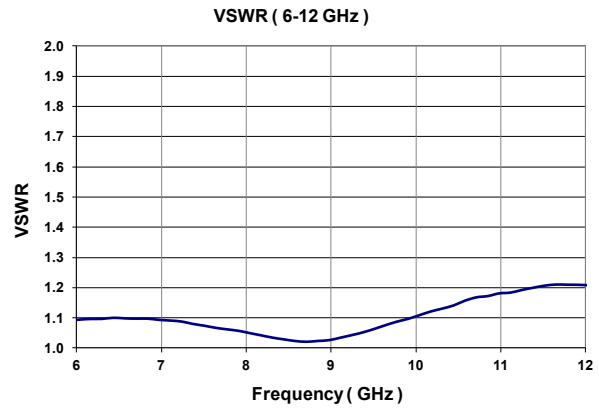
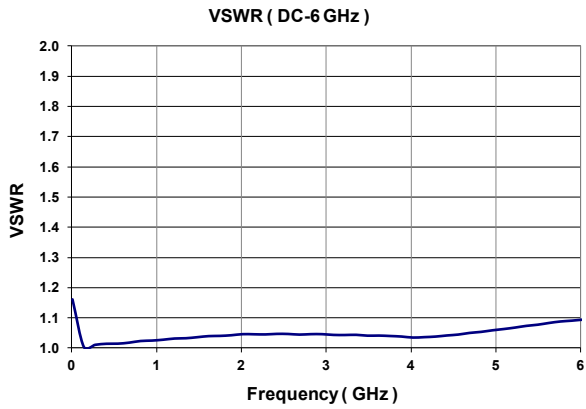

18GHz+ ELITE MODEL ONLY

RF NOTES

[Empty box for RF notes]

GLOSSARY

Actuator

An actuator is the electromechanical mechanism that transfers the RF contacts from one position to another upon DC command.

Arc Suppression Diode

A diode is connected in parallel with the coil. This diode limits the “reverse EMF spike” generated when the coil de-energizes to 0.7 volts. The diode cathode is connected to the positive side of the coil and the anode is connected to the negative side.

Date Code

All switches are marked with either a unique serial number or a date code. Date codes are in accordance with MIL-STD-1285 Paragraph 5.2.5 and consist of four digits. The first two digits define the year and the last two digits define the week of the year (YYWW). Thus, 1032 identifies switches that passed through final inspection during the 32nd week of 2010.

Indicator

Indicators tell the system which position the switch is in. Other names for indicators are telemetry contacts or tellback circuit. Indicators are usually a set of internally mounted DC contacts linked to the actuator. They can be wired to digital input lines, status lights, or interlocks. Unless otherwise specified, the maximum indicator contact rating is 30 Vdc, 50 mA, or 1.5 Watts into a resistive load.

Isolation

Isolation is the measure of the power level at the output connector of an unconnected RF channel as referenced to the power at the input connector. It is specified in dB below the input power level.

Multi-Throw Switch

A multi-throw switch is a switch with one input and three or more output ports. The CCR-38 can switch a microwave signal to any of 2,3,4,5 or 6 output from a single common input.

Switching Time

Switching time is the total interval beginning with the arrival of the leading edge of the command pulse at the switch DC input and ending with the completion of the switch transfer, including contact bounce. It consists of three parts: (1) inductive delay in the coil, (2) transfer time of the physical movement of the contacts, and (3) the bounce time of the RF contacts.

TTL Switch Driver Option

As a special option, switch drivers can be provided for both failsafe and latching switches, which are compatible with industry-standard low-power Schottky TTL circuits.

Performance Parameters vs Frequency

Generally speaking, the RF performance of coaxial switches is frequency dependent. With increasing frequency, VSWR and insertion loss increase while isolation decreases. All data sheets specify these three parameters as “worst case” at the highest operating frequency. If the switch is to be used over a narrow frequency band, better performance can be achieved.

Actuator Current vs Temperature

The resistance of the actuator coil varies as a function of temperature. There is an inverse relationship between the operating temperature of the switch and the actuator drive current. For switches operating at 28 VDC, the approximate actuator drive current at temperature, T, can be calculated using the equation:

$$I_T = \frac{I_A}{[1 + .00385 (T-20)]}$$

Where:

I_T = Actuator current at temperature, T

I_A = Room temperature actuator current – see data sheet

T = Temperature of interest in °C

Magnetic Sensitivity

An electro-mechanical switch can be sensitive to ferrous materials and external magnetic fields. Neighboring ferrous materials should be permitted no closer than 0.5 inches and adjacent external magnetic fields should be limited to a flux density of less than 5 Gauss.

SPECIAL FEATURE

Switching High-Power or Highly Sensitive Signals

Ensure the most linear response with the best galvanically matched contact system in the industry. Extremely low passive intermodulation is standard on all of our switches.

Carrier Frequency 1	Carrier Frequency 2	PIM 3rd Order Frequency	PIM 5th Order Frequency
870 MHz	893 MHz	847 MHz	824 MHz

	3rd Order Intermodulation	5th Order Intermodulation
Multiple Positions	-96 dBm	-115 dBm
	-139 dBc	-158 dBc