

| PART NUMBER | DESCRIPTION                                |
|-------------|--|
| CCR-49K     | Commercial Latching Multi-throw, DC-40 GHz |
| CR-49K      | Elite Latching Multi-throw, DC-40GHz       |

The CCR-49K/CR-49K is a broadband, multi-throw, electromechanical coaxial switch designed to switch a microwave signal from a common input to any of 3, 4, 5, or 6 outputs. The characteristic impedance is 50 Ohms. The switches are small using the popular connector spacing on a 1.062" dia. circle. Each position has an individual actuator mechanism allowing random position selection. This also minimizes switching time.

The CCR-49K/CR-49K comes with a latching actuator. The latching switch remains in the last position selected when the switch is de-energized. STD dual command requires a reset pulse before a new selected position. A separate reset circuit allows all positions to be set to an open position. User must provide both reset (clear) and set (select new position) commands.



Available with USB & Ethernet Control!



| ENVIRONMENTAL AND PHYSICAL CHARACTERISTICS                     |                       |
|--|-----------------------|
| Operating Temperature  |                       |
| Commercial Model, CCR-49K                                      | -25°C to 65°C         |
| Elite Model, CR-49K***   | -55°C to 85°C         |
| Vibration (MIL-STD-202 Method 214, Condition D, non-operating) | 10 g's RMS            |
| Shock (MIL-STD-202 Method 213, Condition D, non-operating)     | 500 g's               |
| Standard Actuator Life   | 5,000,000 cycles      |
| Actuator Life w/ Additional Features                           | 1,000,000 cycles      |
| Connector Type   | 2.92mm (K)            |
| Humidity (Moisture Seal)                                       | Available             |
| Weight   | 6 oz. (170.1g) (max.) |

| ELECTRICAL CHARACTERISTICS     |                                |
|--------------------------------|--------------------------------|
| Form Factor                    | Multi-Throw, break before make |
| Frequency Range                |                                |
| CCR-49K                        | DC-40 GHz                      |
| CR-49K                         | DC-40 GHz                      |
| Characteristic Impedance       | 50 Ohms                        |
| Operate Time                   | 20 ms (max.)                   |
| Actuation Voltage Available    | 12 15 24 28 V                  |
| Actuation Current              | 255 205 130 90 mA              |
| Reset Current (# of Positions) | 3 765 615 390 270 mA           |
|                                | 4 1020 820 520 360 mA          |
|                                | 5 1275 1025 650 450 mA         |
|                                | 6 1530 1230 780 540 mA         |

| PERFORMANCE CHARACTERISTICS |          |          |           |             |             |           |
|-----------------------------|----------|----------|-----------|-------------|-------------|-----------|
| Frequency                   | DC-6 GHz | 6-12 GHz | 12-18 GHz | 18-26.5 GHz | 26.5-32 GHz | 32-40 GHz |
| Insertion Loss, dB, max.    | 0.20     | 0.30     | 0.60      | 0.80        | .80         | 1.40      |
| Isolation, dB, min.         | 80       | 75       | 70        | 70          | 60          | 60        |
| VSWR, max.                  | 1.25:1   | 1.30:1   | 1.60:1    | 1.70:1      | 1.80:1      | 1.95:1    |

For maximum limits, please see charts on pages 7-8

**PART NUMBERING SYSTEM**



| CONNECTOR        | ACTUATOR VOLTAGE   | NUMBER OF POSITIONS | ACTUATOR TYPE            | OPTIONS                                  |
|------------------|--------------------|---------------------|--------------------------|--|
| K: 2.92mm FEMALE | 6: 28 VDC LATCHING | 3: SP3T             | 0: NO INDICATOR CONTACTS | T: TTL DRIVERS WITH DIODES               |
|                  | 7: 15 VDC LATCHING | 4: SP4T             | C: INDICATOR CONTACTS*** | D: COIL TRANSIENT SUPPRESSION DIODES     |
|                  | 8: 12 VDC LATCHING | 5: SP5T             | D: SELF CUTOFF ONLY      | R: POSITIVE + COMMON                     |
|                  | 9: 24 VDC LATCHING | 6: SP6T             |                          | TD: DECODERS AND TTL DRIVERS WITH DIODES |
|                  |                    |                     |                          | M: MOISTURE SEAL                         |
|                  |                    |                     |                          | S: D-SUB CONNECTOR*                      |

\*\*SEE PARTS LIST ON PAGE 11-13

\*\*\*Indicator Contacts Operating Temperature -50°C to 85°C (Elite Model Only)

\* D-Sub Connector may be 9, 15, or 25 pin depending on number of throws. (See Connector Pinout page)

For additional options, please contact factory.

# Series CCR-49K/CR-49K

Multi-Throw DC-40 GHz, SP3T-SP6T  
Latching Coaxial Switch



## SCHEMATICS AND MECHANICAL OUTLINE



**Basic**



**Positive Common**



**Indicators & TTL**

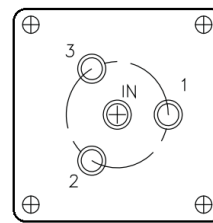

**SP3T**

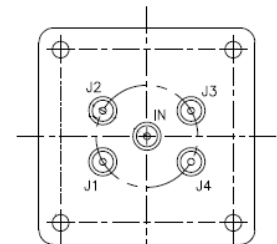

**SP4T**

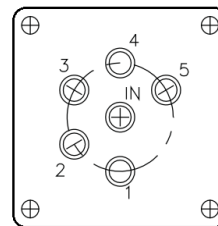

**SP5T**

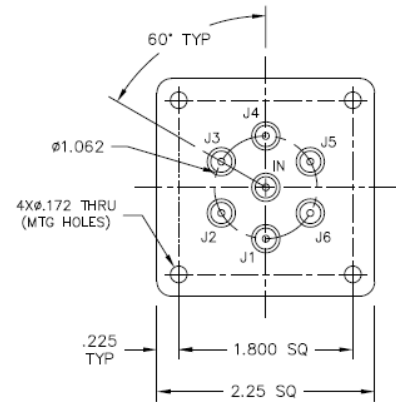

**SP6T**

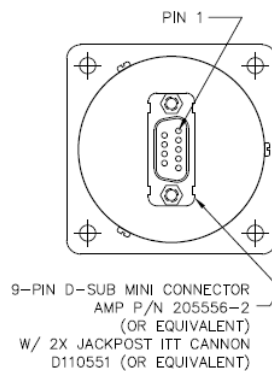
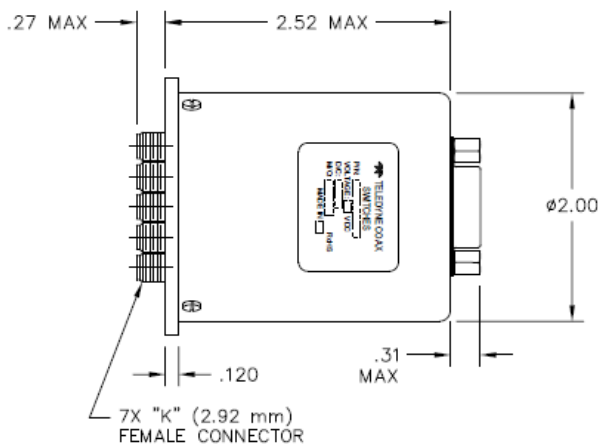

**D-Sub**

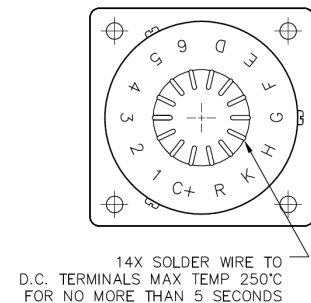

**Basic**

| CONNECTOR PINOUT FOR LATCHING SP3T MULTI-THROW SWITCHES |             |                   |              |                   |               |                   |
|---|-------------|-------------------|--------------|-------------------|---------------|-------------------|
| EXAMPLE   | CR-49K630-S | CR-49K63C-S       | CR-49K630-TS | CR-49K63C-TS      | CR-49K630-TDS | CR-49K63C-TDS     |
| INDICATOR   |             | Yes               |              | Yes               |               | Yes               |
| TTL   |             |                   | Yes          | Yes               |               |                   |
| DECODERS & TTL  |             |                   |              |                   | Yes           | Yes               |
| PIN NO.   | 9-PIN       | 15-PIN            | 9-PIN        | 15-PIN            | 9-PIN         | 15-PIN            |
| 1   | PORT 1      | PORT 1            | TTL 1        | TTL 1             | LOGIC 1       | LOGIC 1           |
| 2   | PORT 2      | PORT 2            | TTL 2        | TTL 2             | LOGIC 2       | LOGIC 2           |
| 3   | PORT 3      | PORT 3            | TTL 3        | TTL 3             | LOGIC 3       | LOGIC 3           |
| 4   |             |                   |              |                   |               |                   |
| 5   |             |                   |              |                   |               |                   |
| 6   |             |                   |              |                   |               |                   |
| 7   | COMMON      | COMMON            | COMMON       | COMMON            | COMMON        | COMMON            |
| 8   | RESET       | RESET             | RESET        | RESET             |               |                   |
| 9   |             |                   | VSW          | VSW               | VSW           | VSW               |
| 10  |             | D INDICATOR (COM) |              | D INDICATOR (COM) |               | D INDICATOR (COM) |
| 11  |             | E INDICATOR       |              | E INDICATOR       |               | E INDICATOR       |
| 12  |             | F INDICATOR       |              | F INDICATOR       |               | F INDICATOR       |
| 13  |             | G INDICATOR       |              | G INDICATOR       |               | G INDICATOR       |
| 14  |             |                   |              |                   |               |                   |
| 15  |             |                   |              |                   |               |                   |



**9-PIN D-SUB CONNECTOR**

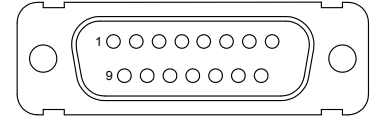

**15-PIN D-SUB CONNECTOR**

“-S option” 9-pin, 15-pin connector  
(example: [CCR-49KS660-S](#))

| CONNECTOR PINOUT FOR LATCHING SP4T MULTI-THROW SWITCHES |             |                   |              |                   |               |                   |
|---|-------------|-------------------|--------------|-------------------|---------------|-------------------|
| EXAMPLE   | CR-49K640-S | CR-49K64C-S       | CR-49K640-TS | CR-49K64C-TS      | CR-49K640-TDS | CR-49K64C-TDS     |
| INDICATOR   |             | Yes               |              | Yes               |               | Yes               |
| TTL   |             |                   | Yes          | Yes               |               |                   |
| DECODERS & TTL  |             |                   |              |                   | Yes           | Yes               |
| PIN NO.   | 9-PIN       | 15-PIN            | 9-PIN        | 15-PIN            | 9-PIN         | 15-PIN            |
| 1   | PORT 1      | PORT 1            | TTL 1        | TTL 1             | LOGIC 1       | LOGIC 1           |
| 2   | PORT 2      | PORT 2            | TTL 2        | TTL 2             | LOGIC 2       | LOGIC 2           |
| 3   | PORT 3      | PORT 3            | TTL 3        | TTL 3             | LOGIC 3       | LOGIC 3           |
| 4   | PORT 4      | PORT 4            | TTL 4        | TTL 4             |               |                   |
| 5   |             |                   |              |                   |               |                   |
| 6   |             |                   |              |                   |               |                   |
| 7   | COMMON      | COMMON            | COMMON       | COMMON            | COMMON        | COMMON            |
| 8   | RESET       | RESET             | RESET        | RESET             |               |                   |
| 9   |             |                   | VSW          | VSW               | VSW           | VSW               |
| 10  |             | D INDICATOR (COM) |              | D INDICATOR (COM) |               | D INDICATOR (COM) |
| 11  |             | E INDICATOR       |              | E INDICATOR       |               | E INDICATOR       |
| 12  |             | F INDICATOR       |              | F INDICATOR       |               | F INDICATOR       |
| 13  |             | G INDICATOR       |              | G INDICATOR       |               | G INDICATOR       |
| 14  |             | H INDICATOR       |              | H INDICATOR       |               | H INDICATOR       |
| 15  |             |                   |              |                   |               |                   |

| CONNECTOR PINOUT FOR LATCHING SP5T MULTI-THROW SWITCHES |             |                   |              |                   |               |                   |
|---|-------------|-------------------|--------------|-------------------|---------------|-------------------|
| EXAMPLE   | CR-49K650-S | CR-49K65C-S       | CR-49K650-TS | CR-49K65C-TS      | CR-49K650-TDS | CR-49K65C-TDS     |
| INDICATOR   |             | Yes               |              | Yes               |               | Yes               |
| TTL   |             |                   | Yes          | Yes               |               |                   |
| DECODERS & TTL  |             |                   |              |                   | Yes           | Yes               |
| PIN NO.   | 9-PIN       | 15-PIN            | 9-PIN        | 15-PIN            | 9-PIN         | 15-PIN            |
| 1   | PORT 1      | PORT 1            | TTL 1        | TTL 1             | LOGIC 1       | LOGIC 1           |
| 2   | PORT 2      | PORT 2            | TTL 2        | TTL 2             | LOGIC 2       | LOGIC 2           |
| 3   | PORT 3      | PORT 3            | TTL 3        | TTL 3             | LOGIC 3       | LOGIC 3           |
| 4   | PORT 4      | PORT 4            | TTL 4        | TTL 4             |               |                   |
| 5   | PORT 5      | PORT 5            | TTL 5        | TTL 5             |               |                   |
| 6   |             |                   |              |                   |               |                   |
| 7   | COMMON      | COMMON            | COMMON       | COMMON            | COMMON        | COMMON            |
| 8   | RESET       | RESET             | RESET        | RESET             |               |                   |
| 9   |             |                   | VSW          | VSW               | VSW           | VSW               |
| 10  |             | D INDICATOR (COM) |              | D INDICATOR (COM) |               | D INDICATOR (COM) |
| 11  |             | E INDICATOR       |              | E INDICATOR       |               | E INDICATOR       |
| 12  |             | F INDICATOR       |              | F INDICATOR       |               | F INDICATOR       |
| 13  |             | G INDICATOR       |              | G INDICATOR       |               | G INDICATOR       |
| 14  |             | H INDICATOR       |              | H INDICATOR       |               | H INDICATOR       |
| 15  |             | K INDICATOR       |              | K INDICATOR       |               | K INDICATOR       |

**Series CCR-49K/CR-49K**  
**Multi-Throw DC-40 GHz, SP3T-SP6T**  
**Latching Coaxial Switch**



| CONNECTOR PINOUT FOR LATCHING SP6T MULTI-THROW SWITCHES |             |                   |              |                   |               |                   |
|---|-------------|-------------------|--------------|-------------------|---------------|-------------------|
| EXAMPLE   | CR-49K660-S | CR-49K66C-S       | CR-49K660-TS | CR-49K66C-TS      | CR-49K660-TDS | CR-49K66C-TDS     |
| INDICATOR   |             | YES               |              | YES               |               | YES               |
| TTL   |             |                   | YES          | YES               |               | YES               |
| DECODERS & TTL  |             |                   |              |                   | YES           | YES               |
| PIN NO.   | 9-PIN       | 15-PIN            | 9-PIN        | 15-PIN            | 9-PIN         | 15-PIN            |
| 1   | PORT 1      | PORT 1            | TTL 1        | TTL 1             | LOGIC 1       | LOGIC 1           |
| 2   | PORT 2      | PORT 2            | TTL 2        | TTL 2             | LOGIC 2       | LOGIC 2           |
| 3   | PORT 3      | PORT 3            | TTL 3        | TTL 3             | LOGIC 3       | LOGIC 3           |
| 4   | PORT 4      | PORT 4            | TTL 4        | TTL 4             |               |                   |
| 5   | PORT 5      | PORT 5            | TTL 5        | TTL 5             |               | VSW               |
| 6   | PORT 6      | PORT 6            | TTL 6        | TTL 6             |               |                   |
| 7   | COMMON      | COMMON            | COMMON       | COMMON            | COMMON        | COMMON            |
| 8   | RESET       | RESET             | RESET        | RESET             |               |                   |
| 9   |             | D INDICATOR (COM) | VSW          | VSW               | VSW           | D INDICATOR (COM) |
| 10  |             | E INDICATOR       |              |                   |               | E INDICATOR       |
| 11  |             | F INDICATOR       |              |                   |               | F INDICATOR       |
| 12  |             | G INDICATOR       |              |                   |               | G INDICATOR       |
| 13  |             | H INDICATOR       |              |                   |               | H INDICATOR       |
| 14  |             | K INDICATOR       |              |                   |               | K INDICATOR       |
| 15  |             | L INDICATOR       |              |                   |               | L INDICATOR       |
| 16  |             |                   |              | D INDICATOR (COM) |               |                   |
| 17  |             |                   |              | E INDICATOR       |               |                   |
| 18  |             |                   |              | F INDICATOR       |               |                   |
| 19  |             |                   |              | G INDICATOR       |               |                   |
| 20  |             |                   |              | H INDICATOR       |               |                   |
| 21  |             |                   |              | K INDICATOR       |               |                   |
| 22  |             |                   |              | L INDICATOR       |               |                   |
| 23  |             |                   |              |                   |               |                   |
| 24  |             |                   |              |                   |               |                   |
| 25  |             |                   |              |                   |               |                   |



**9-PIN D-SUB CONNECTOR**



**15-PIN D-SUB CONNECTOR**



**25-PIN D-SUB CONNECTOR**

“-S option” 9-pin, 15-pin, 25-pin connector  
 (example: **CCR-49KS660-S**)

TRUTH TABLE Latching  
CCR-49KX3C-T

| Logic Input |   |   |   | RF Path |     |     |       | Indicator Switches |   |   |
|-------------|---|---|---|---------|-----|-----|-------|--------------------|---|---|
| 1           | 2 | 3 | R | J1      | J2  | J3  | Reset | E                  | F | G |
| 1           | 0 | 0 | 0 | On      | Off | Off | Off   | C                  | 0 | 0 |
| 0           | 1 | 0 | 0 | Off     | On  | Off | Off   | 0                  | C | 0 |
| 0           | 0 | 1 | 0 | Off     | Off | On  | Off   | 0                  | 0 | C |

TRUTH TABLE Latching  
CCR-49KX3C-TD

| Logic Input |   |   | RF Path  |     |     |       | Indicator Switches |   |   |
|-------------|---|---|----------|-----|-----|-------|--------------------|---|---|
| 1           | 2 | 3 | J1       | J2  | J3  | Reset | E                  | F | G |
| 0           | 0 | 0 | On       | Off | Off | Off   | C                  | 0 | 0 |
| 1           | 0 | 0 | Off      | On  | Off | Off   | 0                  | C | 0 |
| 0           | 1 | 0 | Off      | Off | On  | Off   | 0                  | 0 | C |
| 0           | 1 | 1 | Off      | Off | Off | Reset | 0                  | 0 | 0 |
| 1           | 1 | 1 | COIL OFF |     |     |       | 0                  | 0 | 0 |

TRUTH TABLE Latching  
CCR-49KX4C-T

| Logic Input |   |   |   |   | RF Path |     |     |     |       | Indicator Switches |   |   |   |
|-------------|---|---|---|---|---------|-----|-----|-----|-------|--------------------|---|---|---|
| 1           | 2 | 3 | 4 | R | J1      | J2  | J3  | J4  | Reset | E                  | F | G | H |
| 1           | 0 | 0 | 0 | 0 | On      | Off | Off | Off | Off   | C                  | 0 | 0 | 0 |
| 0           | 1 | 0 | 0 | 0 | Off     | On  | Off | Off | Off   | 0                  | C | 0 | 0 |
| 0           | 0 | 1 | 0 | 0 | Off     | Off | On  | Off | Off   | 0                  | 0 | C | 0 |
| 0           | 0 | 0 | 1 | 0 | Off     | Off | Off | On  | Off   | 0                  | 0 | 0 | C |

TRUTH TABLE Latching  
CCR-49KX4C-TD

| Logic Input |   |   | RF Path  |     |     |     |       | Indicator Switches |   |   |   |
|-------------|---|---|----------|-----|-----|-----|-------|--------------------|---|---|---|
| 1           | 2 | 3 | J1       | J2  | J3  | J4  | Reset | E                  | F | G | H |
| 0           | 0 | 0 | On       | Off | Off | Off | Off   | C                  | 0 | 0 | 0 |
| 1           | 0 | 0 | Off      | On  | Off | Off | Off   | 0                  | C | 0 | 0 |
| 0           | 1 | 0 | Off      | Off | On  | Off | Off   | 0                  | 0 | C | 0 |
| 1           | 1 | 0 | Off      | Off | Off | On  | Off   | 0                  | 0 | 0 | C |
| 0           | 1 | 1 | Off      | Off | Off | Off | Reset | 0                  | 0 | 0 | 0 |
| 1           | 1 | 1 | COIL OFF |     |     |     |       | 0                  | 0 | 0 | 0 |

# Series CCR-49K/CR-49K

Multi-Throw DC-40 GHz, SP3T-SP6T  
Latching Coaxial Switch



## TRUTH TABLE Latching CCR-49KX5C-T

| Logic Input |   |   |   |   |   | RF Path |     |     |     |     |       | Indicator Switches |   |   |   |   |
|-------------|---|---|---|---|---|---------|-----|-----|-----|-----|-------|--------------------|---|---|---|---|
| 1           | 2 | 3 | 4 | 5 | R | J1      | J2  | J3  | J4  | J5  | Reset | E                  | F | G | H | K |
| 1           | 0 | 0 | 0 | 0 | 0 | On      | Off | Off | Off | Off | Off   | C                  | 0 | 0 | 0 | 0 |
| 0           | 1 | 0 | 0 | 0 | 0 | Off     | On  | Off | Off | Off | Off   | 0                  | C | 0 | 0 | 0 |
| 0           | 0 | 1 | 0 | 0 | 0 | Off     | Off | On  | Off | Off | Off   | 0                  | 0 | C | 0 | 0 |
| 0           | 0 | 0 | 1 | 0 | 0 | Off     | Off | Off | On  | Off | Off   | 0                  | 0 | 0 | C | 0 |
| 0           | 0 | 0 | 0 | 1 | 0 | Off     | Off | Off | Off | On  | Off   | 0                  | 0 | 0 | 0 | C |

## TRUTH TABLE Latching CCR-49KX5C-TD

| Logic Input |   |   | RF Path  |     |     |     |     | Indicator Switches |   |   |   |   |   |
|-------------|---|---|----------|-----|-----|-----|-----|--------------------|---|---|---|---|---|
| 1           | 2 | 3 | J1       | J2  | J3  | J4  | J5  | Reset              | E | F | G | H | K |
| 0           | 0 | 0 | On       | Off | Off | Off | Off | Off                | C | 0 | 0 | 0 | 0 |
| 1           | 0 | 0 | Off      | On  | Off | Off | Off | Off                | 0 | C | 0 | 0 | 0 |
| 0           | 1 | 0 | Off      | Off | On  | Off | Off | Off                | 0 | 0 | C | 0 | 0 |
| 1           | 1 | 0 | Off      | Off | Off | On  | Off | Off                | 0 | 0 | 0 | C | 0 |
| 0           | 0 | 1 | Off      | Off | Off | Off | On  | Off                | 0 | 0 | 0 | 0 | C |
| 0           | 1 | 1 | Off      | Off | Off | Off | Off | Reset              | 0 | 0 | 0 | 0 | 0 |
| 1           | 1 | 1 | COIL OFF |     |     |     |     | 0                  | 0 | 0 | 0 | 0 |   |

## TRUTH TABLE Latching CCR-49KX6C-T

| Logic Input |   |   |   |   |   |   | RF Path |     |     |     |     |     | Indicator Switches |   |   |   |   |   |   |
|-------------|---|---|---|---|---|---|---------|-----|-----|-----|-----|-----|--------------------|---|---|---|---|---|---|
| 1           | 2 | 3 | 4 | 5 | 6 | R | J1      | J2  | J3  | J4  | J5  | J6  | Reset              | E | F | G | H | K | L |
| 1           | 0 | 0 | 0 | 0 | 0 | 0 | On      | Off | Off | Off | Off | Off | Off                | C | 0 | 0 | 0 | 0 | 0 |
| 0           | 1 | 0 | 0 | 0 | 0 | 0 | Off     | On  | Off | Off | Off | Off | Off                | 0 | C | 0 | 0 | 0 | 0 |
| 0           | 0 | 1 | 0 | 0 | 0 | 0 | Off     | Off | On  | Off | Off | Off | Off                | 0 | 0 | C | 0 | 0 | 0 |
| 0           | 0 | 0 | 1 | 0 | 0 | 0 | Off     | Off | Off | On  | Off | Off | Off                | 0 | 0 | 0 | C | 0 | 0 |
| 0           | 0 | 0 | 0 | 1 | 0 | 0 | Off     | Off | Off | Off | On  | Off | Off                | 0 | 0 | 0 | 0 | C | 0 |
| 0           | 0 | 0 | 0 | 0 | 1 | 0 | Off     | Off | Off | Off | Off | On  | Off                | 0 | 0 | 0 | 0 | 0 | C |

## TRUTH TABLE Latching CCR-49KX6C-TD

| Logic Input |   |   | RF Path  |     |     |     |     |     | Indicator Switches |   |   |   |   |   |   |
|-------------|---|---|----------|-----|-----|-----|-----|-----|--------------------|---|---|---|---|---|---|
| 1           | 2 | 3 | J1       | J2  | J3  | J4  | J5  | J6  | Reset              | E | F | G | H | K | L |
| 0           | 0 | 0 | On       | Off | Off | Off | Off | Off | Off                | C | 0 | 0 | 0 | 0 | 0 |
| 1           | 0 | 0 | Off      | On  | Off | Off | Off | Off | Off                | 0 | C | 0 | 0 | 0 | 0 |
| 0           | 1 | 0 | Off      | Off | On  | Off | Off | Off | Off                | 0 | 0 | C | 0 | 0 | 0 |
| 1           | 1 | 0 | Off      | Off | Off | On  | Off | Off | Off                | 0 | 0 | 0 | C | 0 | 0 |
| 0           | 0 | 1 | Off      | Off | Off | Off | On  | Off | Off                | 0 | 0 | 0 | 0 | C | 0 |
| 1           | 0 | 1 | Off      | Off | Off | Off | Off | On  | Off                | 0 | 0 | 0 | 0 | 0 | C |
| 0           | 1 | 1 | Off      | Off | Off | Off | Off | Off | Reset              | 0 | 0 | 0 | 0 | 0 | 0 |
| 1           | 1 | 1 | COIL OFF |     |     |     |     |     | 0                  | 0 | 0 | 0 | 0 | 0 |   |

**TYPICAL RF PERFORMANCE CURVES**

**INSERTION LOSS**



**VSWR**



TYPICAL RF PERFORMANCE CURVES

### ISOLATION





TYPICAL POWER PERFORMANCE CURVE

# Power Handling vs. Frequency



Estimates based on the following reference conditions:

- Ambient temperature of 40°C or less
- Sea level operation
- Load VSWR of 1.20:1 maximum
- No high-power (hot) switching

Please contact Teledyne Coax Switches for derating factors when applications do not meet the foregoing reference conditions.