

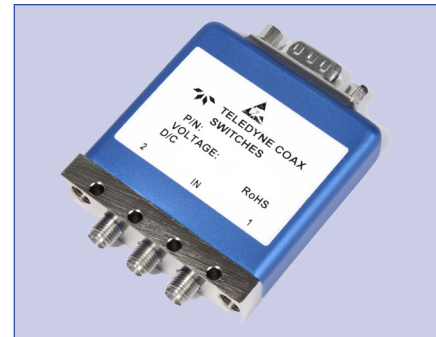

PART NUMBER	DESCRIPTION
CCRT-40	Commercial, internally terminated single pole double throw fail-safe coaxial switch
CRT-40	Elite, internally terminated single pole double throw fail-safe coaxial switch

The CRT/CCRT-40 is an internally terminated, broadband, SPDT, electromechanical coaxial switch designed to switch a microwave signal from a common input to either of two outputs. The switches are available in the frequency range from DC to 40GHz featuring excellent RF and mechanical performance with broadband operation, high isolation and low insertion loss. The characteristic impedance is 50Ω. Internal terminations provide an impedance match for the unselected port, making it ideal for applications where port matching is required.



ENVIRONMENTAL AND PHYSICAL CHARACTERISTICS	
Temperature Range (storage)	-55°C to 100°C
Temperature Range (operating)	
Commercial	-25°C to 65°C
Elite, w/ indicator contacts	-55°C to 85°C
Elite, w/ indicator contacts	-50°C to 85°C
Vibration, 10 - 2,000 Hz	10 g peak
MIL-STD-202 Method 204, Condition C	300 sec
Shock, Half-Sine Pulse	500 g
MIL-STD-202 Method 213, Condition D	1 msec
Standard Actuator Life	5,000,000 cycles
Actuator Life w/ Additional Features	1,000,000 cycles
Connector Type	2.92 mm (K)
Humidity (w/ Moisture Seal Option)	95% non condensing
Weight	2.65 oz. max (75.12 g)

ELECTRICAL CHARACTERISTICS	
RF Contacts	Break before make
Frequency Range	DC – 40 GHz
Characteristic Impedance	50Ω
Terminations	50Ω, 2 Watts CW max
Switching Time	20 msec max
Actuation Voltage (VDC) 20°C	12 15 24 28
Actuation Current (mA)	420 500 280 200
TTL Driver Voltage Range	
ON STATE	2.4 - 5.5 VDC
OFF STATE	0 - 0.8 VDC
Indicator Contact Rating	30 VDC, 50 mA max
Magnetic Sensitivity	5 Gauss, 0.5 inch max

RF CHARACTERISTICS						
Frequency	DC–6 GHz	6–12 GHz	12–18 GHz	18–26.5 GHz	26.5-34 GHz	34-40 GHz
Insertion Loss (max)	0.2 dB	0.3 dB	0.5 dB	0.6 dB	0.7 dB	0.7 dB
Isolation (min)	80 dB	75 dB	70 dB	70 dB	60 dB	60 dB
VSWR (max)	1.20:1	1.30:1	1.50:1	1.60:1	1.60:1	1.60:1

PART NUMBERING SYSTEM

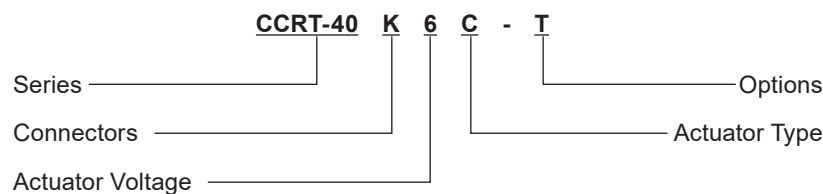

Connectors
2.92 mm (K) Female

Actuator Voltages
1: 28 VDC
2: 15 VDC
3: 12 VDC
4: 24 VDC

Actuator Types
0: Standard Contacts
C: Indicator Contacts

Available Options
T: TTL Driver
D: Transient Suppression and Polarity Protection Diodes
M: Moisture Seal
S: 9-Pin D-Sub Connector (Male)

Please feel free to contact us for more information regarding additional options and custom configurations.

SCHEMATICS AND MECHANICAL OUTLINE

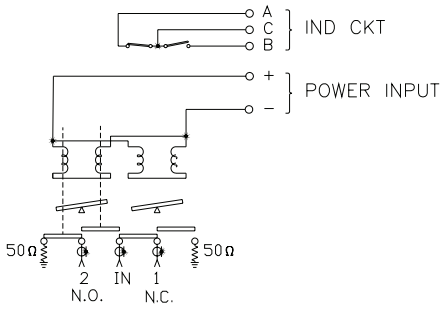

ANALOG INPUT TERMINALS WITH INDICATOR

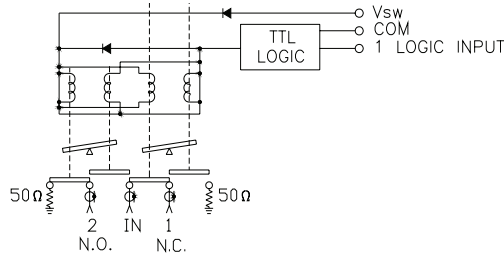

TTL DRIVER

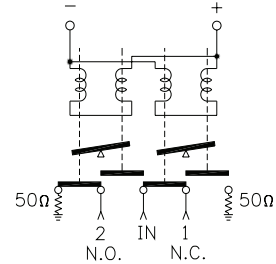

ANALOG INPUT TERMINALS

6X SOLDER WIRE TO D.C. TERMINALS
MAXIMUM TEMP 250°C FOR NO MORE THAN 5 SEC

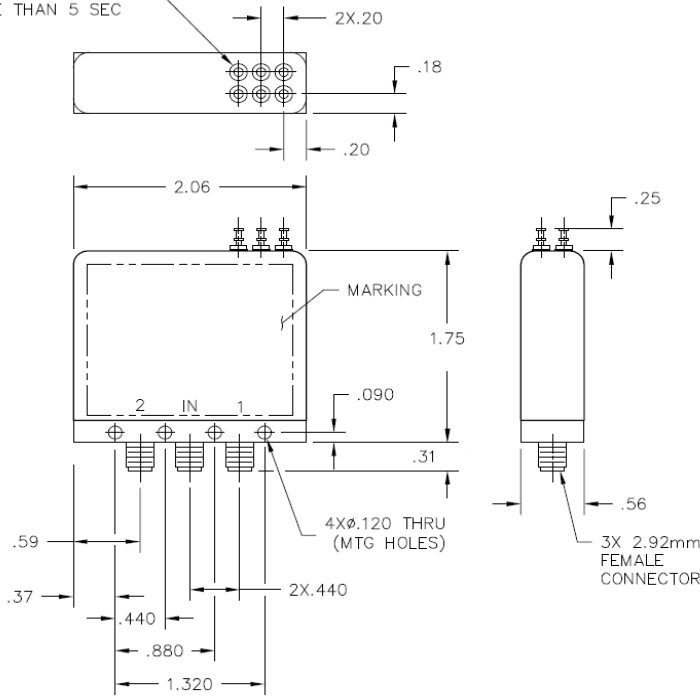

9 PIN D-SUB PINOUT

Pin No.	OPTIONS			
	Basic	Indicators	TTL	Indicators & TTL
1	+	+		
2	-	-		
3			COM	COM
4			1	1
5				
6			VSW	VSW
7		A		A
8		B		B
9		C		C

TRUTH TABLE (w/ TTL Option)

Logic Input	RF Path		Indicator (if applicable)	
1	N.C	N.O	A	B
0	On	Off	C	0
1	Off	On	0	C

TYPICAL RF PERFORMANCE CURVES

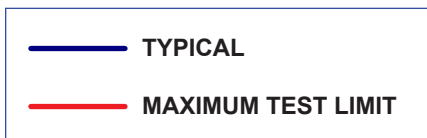
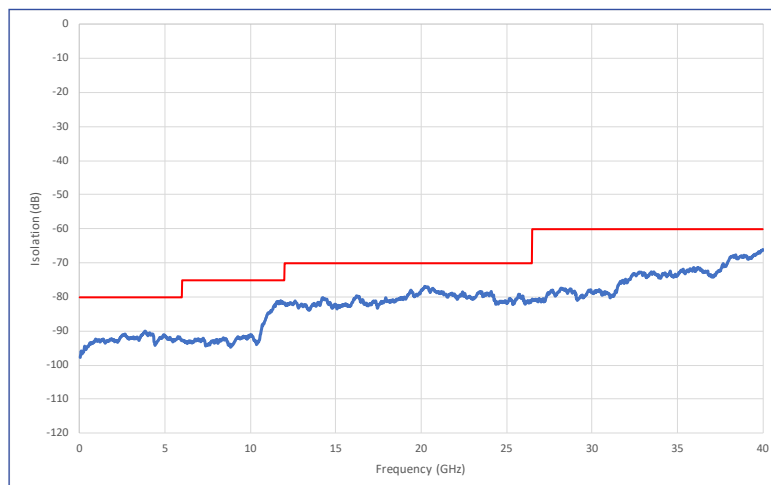
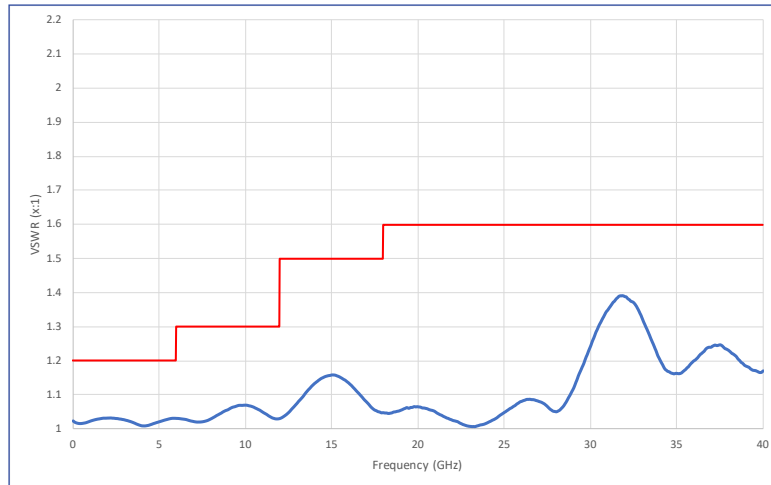
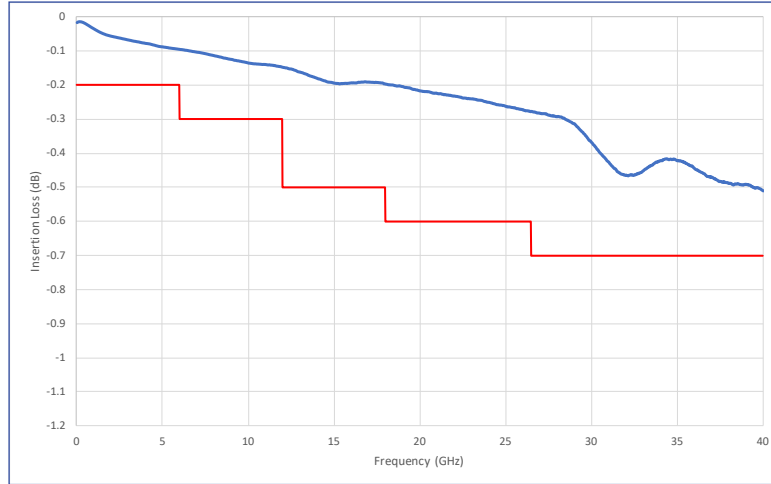

TYPICAL POWER PERFORMANCE CURVE

Power Handling vs. Frequency

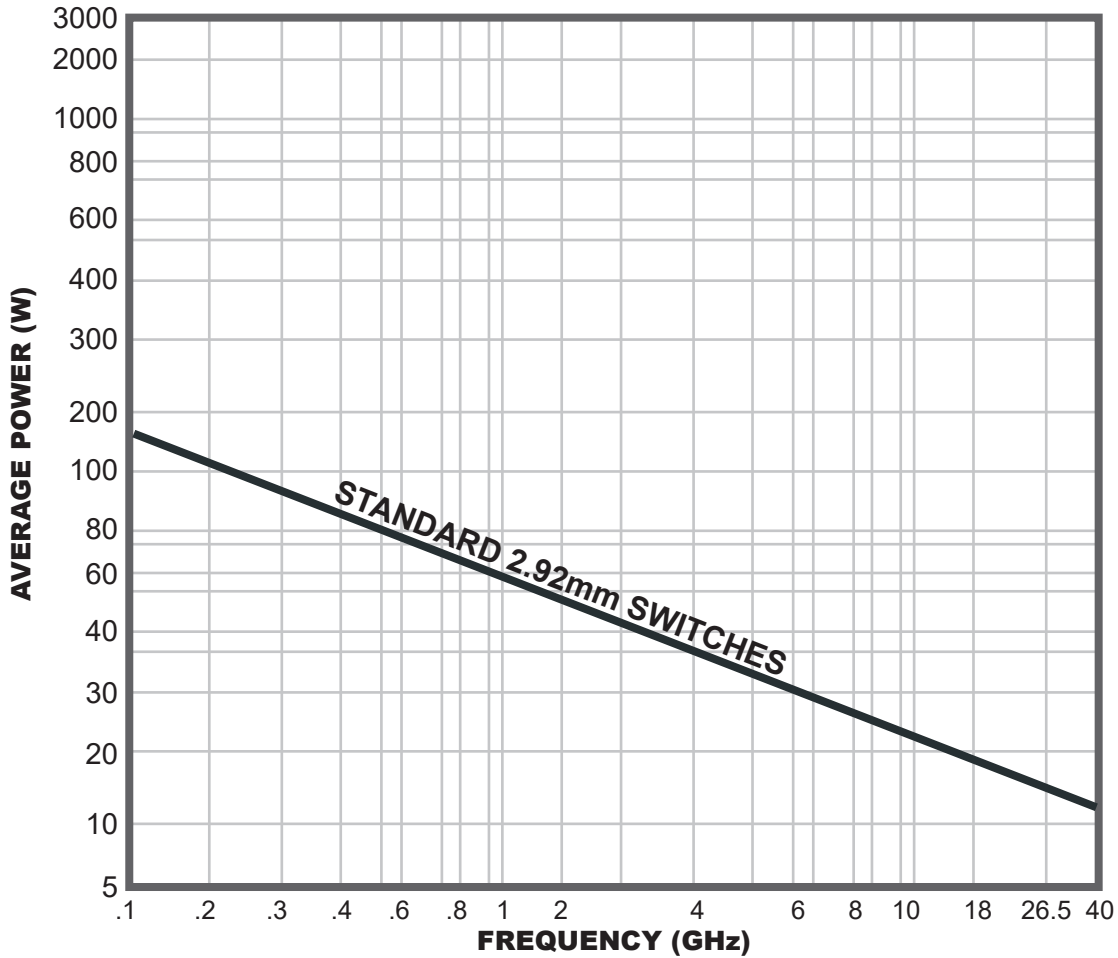

Power Handling Derating vs. Load VSWR

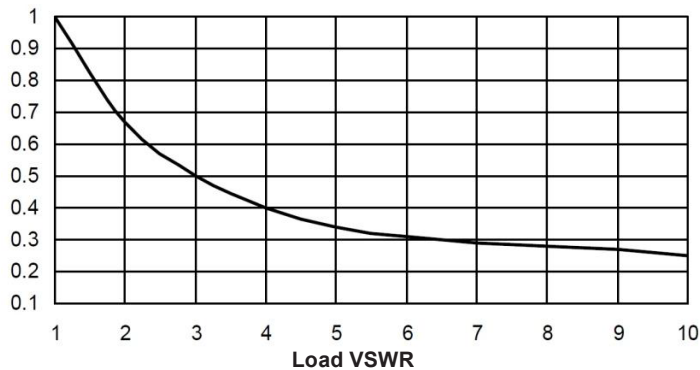

Estimates based on the following reference conditions:

- Ambient temperature of 40°C or less
- Sea level operation
- Load VSWR of 1.20:1 maximum
- No high-power (hot) switching