



PART NUMBER	DESCRIPTION
CCS-18	Commercial Normally Open Multi-throw, DC-12GHz
CS-18	Elite Normally Open Multi-throw, DC-12GHz

The CCS-18/CS-18 is a broadband multi-position coaxial switch designed to switch RF signals from one input port to any one of 3 through 8 output ports. It is readily adapted to any 50 Ohms transmission line system. The standard actuator gives individual solenoid control of each position and when de-energized, all positions are open. Standard actuator voltage is 28 VDC. The primary advantage of this switch over the miniature versions shown on previous pages is the higher power handling capability.



ENVIRONMENTAL AND PHYSICAL CHARACTERISTICS	
Operating Temperature	
Commercial Model, CCS-18	–40°C to 65°C
Elite Model, CS-18	–55°C to 85°C
Vibration (MIL-STD-202 Method 214, Condition D, non-operating)	10 g's RMS
Shock (MIL-STD-202 Method 213, Condition D, non-operating)	500 g's
Standard Actuator Life	3,000,000 cycles
Actuator Life w/ Additional Features	1,000,000 cycles
Connector Type	Type N or TNC
Humidity (Moisture Seal)	Available
Weight	9 oz. (255.2g) (max.)

ELECTRICAL CHARACTERISTICS	
Form Factor	Multi-Throw, break before make
Frequency Range	
CCS-18	DC–12 GHz
CS-18	DC–12 GHz
Characteristic Impedance	50 Ohms
Operate Time	10 ms (max.)
Release Time	10 ms (max.)
Actuation Voltage Available	12 15 24 28 V
Actuation Current, max. @ ambient	600 700 230 270 mA

PERFORMANCE CHARACTERISTICS: N CONNECTOR OPTION (TNC CONNECTOR, 11GHz MAX.)				
Frequency	DC–3 GHz	3–6 GHz	6–9 GHz	9–12 GHz
Insertion Loss, dB, max.	0.2	0.2	0.3	0.4
Isolation, dB, min.	80	80	80	75
VSWR , max.	1.3:1	1.3:1	1.5:1	1.7:1

PART NUMBERING SYSTEM

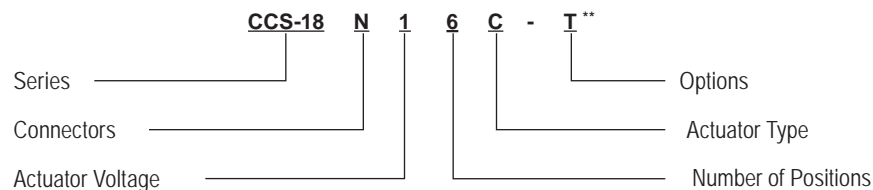

CONNECTOR	ACTUATOR VOLTAGE	NUMBER OF POSITIONS	ACTUATOR TYPE	OPTIONS
N: TYPE N FEMALE	1: 28 VDC NORMALLY OPEN	3: SP3T	0: NO INDICATOR CONTACTS	T: TTL DRIVERS WITH DIODES
T: TNC FEMALE	2: 15 VDC NORMALLY OPEN	4: SP4T	C: INDICATOR CONTACTS	D: COIL TRANSIENT SUPPRESSION DIODES
	3: 12 VDC NORMALLY OPEN	5: SP5T		S: D-SUB CONNECTOR*
	4: 24 VDC NORMALLY OPEN	6: SP6T		TD: DECODERS AND TTL DRIVERS WITH DIODES
		7: SP7T		M: MOISTURE SEAL
		8: SP8T		

**SEE PARTS LIST ON PAGE 13-16

For additional options, please contact factory.

* D-Sub Connector may be 9 or 15 pin depending on number of throws. (See Connector Pinout page)

Series CCS-18/CS-18

High Power Multi-Throw DC-12 GHz
Normally Open Coaxial Switch



SCHEMATICS AND MECHANICAL OUTLINE FOR SP3T-SP6T SWITCHES

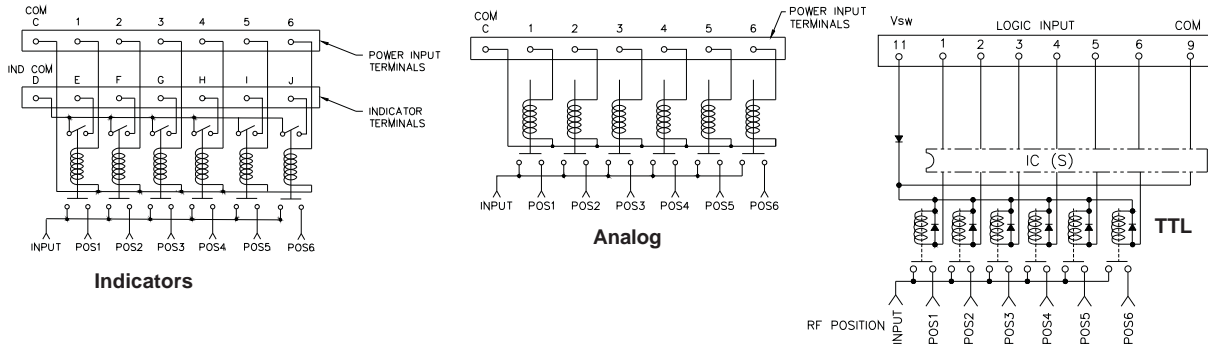

Indicators

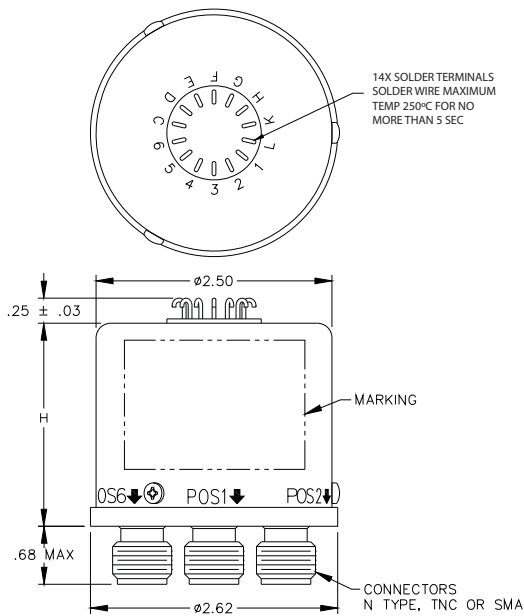

SP3T - SP6T H = 2.15 STD & Indicator Model
SP3T - SP6T H = 2.65 All OTHER Models

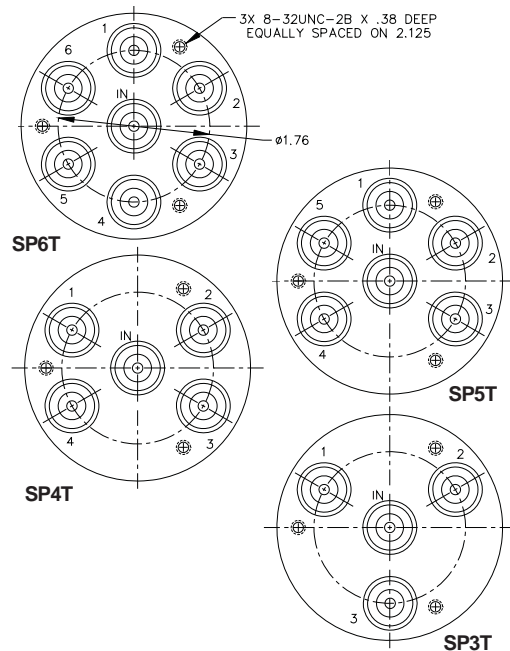

MECHANICAL OUTLINE FOR SP7T & SP8T SWITCHES

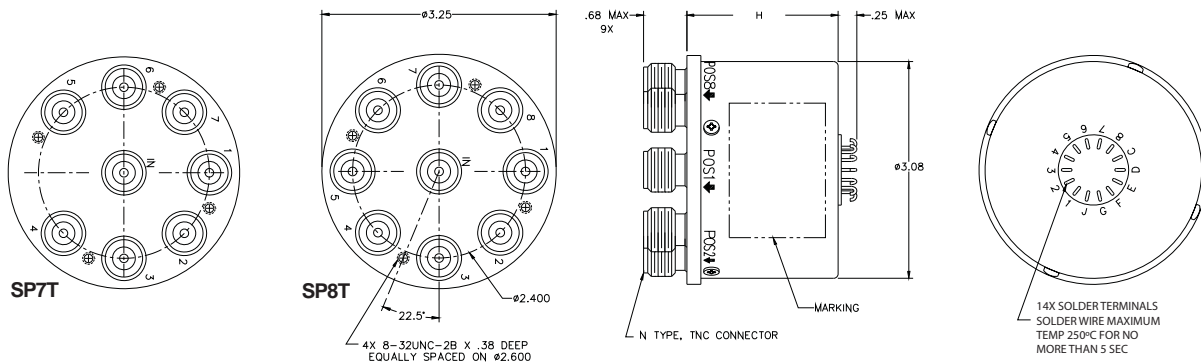

SP7T & SP8T H = 2.15 STD Model
SP7T & SP8T H = 2.65 All OTHER Models

“-s OPTION” 9-PIN D-SUB OR 15-PIN D-MICRO CONNECTOR (EXAMPLE: CCS-18N160-S)

CONNECTOR PINOUT FOR NORMALLY OPEN SP3T MULTI-THROW SWITCHES						
EXAMPLE	CS-18N130-S	CS-18N13C-S	CS-18N130-TS	CS-18N13C-TS	CS-18N130-TDS	CS-18N13C-TDS
INDICATOR		YES		YES		YES
TTL			YES	YES		
DECODERS & TTL					YES	YES
PIN NO.	9-PIN	9-PIN	9-PIN	9-PIN	9-PIN	9-PIN
1	PORT 1	PORT 1	PORT 1	PORT 1	LOGIC 1	LOGIC 1
2	PORT 2	PORT 2	PORT 2	PORT 2	LOGIC 2	LOGIC 2
3	PORT 3	PORT 3	PORT 3	PORT 3		
4		E INDICATOR		E INDICATOR		E INDICATOR
5		F INDICATOR		F INDICATOR		F INDICATOR
6		G INDICATOR		G INDICATOR		G INDICATOR
7	COMMON	COMMON	COMMON	COMMON	COMMON	COMMON
8			VSW	VSW	VSW	VSW
9		D INDICATOR (COM)		D INDICATOR (COM)		D INDICATOR (COM)

CONNECTOR PINOUT FOR NORMALLY OPEN SP4T MULTI-THROW SWITCHES						
EXAMPLE	CS-18N140-S	CS-18N14C-S	CS-18N140-TS	CS-18N14C-TS	CS-18N140-TDS	CS-18N14C-TDS
INDICATOR		YES		YES		YES
TTL			YES	YES		
DECODERS & TTL					YES	YES
PIN NO.	9-PIN	15-PIN	9-PIN	15-PIN	9-PIN	15-PIN
1	PORT 1	PORT 1	TTL 1	TTL 1	LOGIC 1	LOGIC 1
2	PORT 2	PORT 2	TTL 2	TTL 2	LOGIC 2	LOGIC 2
3	PORT 3	PORT 3	TTL 3	TTL 3	LOGIC 3	LOGIC 3
4	PORT 4	PORT 4	TTL 4	TTL 4		
5						
6						
7	COMMON	COMMON	COMMON	COMMON	COMMON	COMMON
8			VSW	VSW	VSW	VSW
9		D INDICATOR (COM)		D INDICATOR (COM)		D INDICATOR (COM)
10		E INDICATOR		E INDICATOR		E INDICATOR
11		F INDICATOR		F INDICATOR		F INDICATOR
12	N/A	G INDICATOR	N/A	G INDICATOR	N/A	G INDICATOR
13		H INDICATOR		H INDICATOR		H INDICATOR
14						
15						

CONNECTOR PINOUT FOR NORMALLY OPEN SP5T MULTI-THROW SWITCHES						
EXAMPLE	CS-18N150-S	CS-18N15C-S	CS-18N150-TS	CS-18N15C-TS	CS-18N150-TDS	CS-18N15C-TDS
INDICATOR		YES		YES		YES
TTL			YES	YES		
DECODERS & TTL					YES	YES
PIN NO.	9-PIN	15-PIN	9-PIN	15-PIN	9-PIN	15-PIN
1	PORT 1	PORT 1	TTL 1	TTL 1	LOGIC 1	LOGIC 1
2	PORT 2	PORT 2	TTL 2	TTL 2	LOGIC 2	LOGIC 2
3	PORT 3	PORT 3	TTL 3	TTL 3	LOGIC 3	LOGIC 3
4	PORT 4	PORT 4	TTL 4	TTL 4		
5	PORT 5	PORT 5	TTL 5	TTL 5		
6						
7	COMMON	COMMON	COMMON	COMMON	COMMON	COMMON
8			VSW	VSW	VSW	VSW
9		D INDICATOR (COM)		D INDICATOR (COM)		D INDICATOR (COM)
10		E INDICATOR		E INDICATOR		E INDICATOR
11		F INDICATOR		F INDICATOR		F INDICATOR
12	N/A	G INDICATOR	N/A	G INDICATOR	N/A	G INDICATOR
13		H INDICATOR		H INDICATOR		H INDICATOR
14		K INDICATOR		K INDICATOR		K INDICATOR
15						

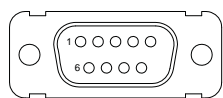

9-PIN D-SUB CONNECTOR

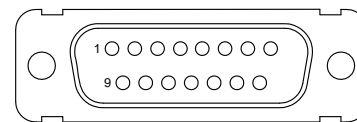

15-PIN D-SUB CONNECTOR

Series CCS-18/CS-18

High Power Multi-Throw DC–12 GHz

Normally Open Coaxial Switch



CONNECTOR PINOUT FOR NORMALLY OPEN SP6T MULTI-THROW SWITCHES						
EXAMPLE	CS-18N160-S	CS-18N16C-S	CS-18N160-TS	CS-18N16C-TS	CS-18N160-TDS	CS-18N16C-TDS
INDICATOR		Yes		Yes		Yes
TTL			Yes	Yes		
DECODERS & TTL					Yes	Yes
PIN NO.	9-PIN	15-PIN	9-PIN	15-PIN	9-PIN	15-PIN
1	PORT 1	PORT 1	TTL 1	TTL 1	LOGIC 1	LOGIC 1
2	PORT 2	PORT 2	TTL 2	TTL 2	LOGIC 2	LOGIC 2
3	PORT 3	PORT 3	TTL 3	TTL 3	LOGIC 3	LOGIC 3
4	PORT 4	PORT 4	TTL 4	TTL 4		
5	PORT 5	PORT 5	TTL 5	TTL 5		
6	PORT 6	PORT 6	TTL 6	TTL 6		
7	COMMON	COMMON	COMMON	COMMON	COMMON	COMMON
8			Vsw	Vsw	Vsw	Vsw
9		D INDICATOR (COM)		D INDICATOR (COM)		D INDICATOR (COM)
10		E INDICATOR		E INDICATOR		E INDICATOR
11		F INDICATOR		F INDICATOR		F INDICATOR
12		G INDICATOR		G INDICATOR		G INDICATOR
13		H INDICATOR		H INDICATOR		H INDICATOR
14		K INDICATOR		K INDICATOR		K INDICATOR
15		L INDICATOR		L INDICATOR		L INDICATOR

CONNECTOR PINOUT FOR NORMALLY OPEN SP7T MULTI-THROW SWITCHES						
EXAMPLE	CS-18N170-S	CS-18N17C-S	CS-18N170-TS	CS-18N17C-TS	CS-18N170-TDS	CS-18N17C-TDS
INDICATOR		Yes		Yes		Yes
TTL			Yes	Yes		
DECODERS & TTL					Yes	Yes
PIN NO.	9-PIN		9-PIN		9-PIN	15-PIN
1	PORT 1		TTL 1		LOGIC 1	LOGIC 1
2	PORT 2		TTL 2		LOGIC 2	LOGIC 2
3	PORT 3		TTL 3		LOGIC 3	LOGIC 3
4	PORT 4		TTL 4			
5	PORT 5		TTL 5		COMMON	COMMON
6	PORT 6		TTL 6		Vsw	Vsw
7	PORT 7		TTL 7			D INDICATOR (COM)
8		CONFIGURATION NOT AVAILABLE CONTACT FACTORY	COMMON	CONFIGURATION NOT AVAILABLE CONTACT FACTORY		E INDICATOR
9	COMMON		Vsw			F INDICATOR
10						G INDICATOR
11						H INDICATOR
12	N/A		N/A		N/A	K INDICATOR
13						L INDICATOR
14						M INDICATOR
15						

CONNECTOR PINOUT FOR NORMALLY OPEN SP8T MULTI-THROW SWITCHES						
EXAMPLE	CS-18N180-S	CS-18N18C-S	CS-18N180-TS	CS-18N18C-TS	CS-18N180-TDS	CS-18N18C-TDS
INDICATOR		Yes		Yes		Yes
TTL			Yes	Yes		
DECODERS & TTL					Yes	Yes
PIN NO.	9-PIN		15-PIN		9-PIN	15-PIN
1	PORT 1		TTL 1		LOGIC 1	LOGIC 1
2	PORT 2		TTL 2		LOGIC 2	LOGIC 2
3	PORT 3		TTL 3		LOGIC 3	LOGIC 3
4	PORT 4		TTL 4		LOGIC 4	LOGIC 4
5	PORT 5		TTL 5		COMMON	COMMON
6	PORT 6		TTL 6		Vsw	Vsw
7	PORT 7		TTL 7			D INDICATOR (COM)
8	PORT 8	CONFIGURATION NOT AVAILABLE CONTACT FACTORY	TTL 8	CONFIGURATION NOT AVAILABLE CONTACT FACTORY		E INDICATOR
9	COMMON		COMMON			F INDICATOR
10			Vsw			G INDICATOR
11						H INDICATOR
12	N/A				N/A	K INDICATOR
13						L INDICATOR
14						M INDICATOR
15						N INDICATOR

TRUTH TABLE Normally Open
CCS-18NX3C-T

Logic Input			RF Path			Indicator Switches		
1	2	3	J1	J2	J3	E	F	G
1	0	0	On	Off	Off	C	0	0
0	1	0	Off	On	Off	0	C	0
0	0	1	Off	Off	On	0	0	C

TRUTH TABLE Normally Open
CCS-18NX3C-TD

Logic Input		RF Path			Indicator Switches		
1	2	J1	J2	J3	E	F	G
0	0	On	Off	Off	C	0	0
1	0	Off	On	Off	0	C	0
0	1	Off	Off	On	0	0	C
1	1	Off	Off	Off	0	0	0

TRUTH TABLE Normally Open
CCS-18NX4C-T

Logic Input				RF Path				Indicator Switches			
1	2	3	4	J1	J2	J3	J4	E	F	G	H
1	0	0	0	On	Off	Off	Off	C	0	0	0
0	1	0	0	Off	On	Off	Off	0	C	0	0
0	0	1	0	Off	Off	On	Off	0	0	C	0
0	0	0	1	Off	Off	Off	On	0	0	0	C

TRUTH TABLE Normally Open
CCS-18NX4C-TD

Logic Input			RF Path				Indicator Switches			
1	2	3	J1	J2	J3	J4	E	F	G	H
0	0	0	On	Off	Off	Off	C	0	0	0
1	0	0	Off	On	Off	Off	0	C	0	0
0	1	0	Off	Off	On	Off	0	0	C	0
1	1	0	Off	Off	Off	On	0	0	0	C
1	1	1	Off	Off	Off	Off	0	0	0	0

Series CCS-18/CS-18
High Power Multi-Throw DC–12 GHz
Normally Open Coaxial Switch



TRUTH TABLE Normally Open
CCS-18NX5C-T

Logic Input					RF Path					Indicator Switches				
1	2	3	4	5	J1	J2	J3	J4	J5	E	F	G	H	K
1	0	0	0	0	On	Off	Off	Off	Off	C	0	0	0	0
0	1	0	0	0	Off	On	Off	Off	Off	0	C	0	0	0
0	0	1	0	0	Off	Off	On	Off	Off	0	0	C	0	0
0	0	0	1	0	Off	Off	Off	On	Off	0	0	0	C	0
0	0	0	0	1	Off	Off	Off	Off	On	0	0	0	0	C

TRUTH TABLE Normally Open
CCS-18NX5C-TD

Logic Input			RF Path					Indicator Switches				
1	2	3	J1	J2	J3	J4	J5	E	F	G	H	K
0	0	0	On	Off	Off	Off	Off	C	0	0	0	0
1	0	0	Off	On	Off	Off	Off	0	C	0	0	0
0	1	0	Off	Off	On	Off	Off	0	0	C	0	0
1	1	0	Off	Off	Off	On	Off	0	0	0	C	0
0	0	1	Off	Off	Off	Off	On	0	0	0	0	C
1	1	1	Off	Off	Off	Off	Off	0	0	0	0	0

TRUTH TABLE Normally Open
CCS-18NX6C-T

Logic Input						RF Path						Indicator Switches					
1	2	3	4	5	6	J1	J2	J3	J4	J5	J6	E	F	G	H	K	L
1	0	0	0	0	0	On	Off	Off	Off	Off	Off	C	0	0	0	0	0
0	1	0	0	0	0	Off	On	Off	Off	Off	Off	0	C	0	0	0	0
0	0	1	0	0	0	Off	Off	On	Off	Off	Off	0	0	C	0	0	0
0	0	0	1	0	0	Off	Off	Off	On	Off	Off	0	0	0	C	0	0
0	0	0	0	1	0	Off	Off	Off	Off	On	Off	0	0	0	0	C	0
0	0	0	0	0	1	Off	Off	Off	Off	Off	On	0	0	0	0	0	C

TRUTH TABLE Normally Open
CCS-18NX6C-TD

Logic Input			RF Path						Indicator Switches					
1	2	3	J1	J2	J3	J4	J5	J6	E	F	G	H	K	L
0	0	0	On	Off	Off	Off	Off	Off	C	0	0	0	0	0
1	0	0	Off	On	Off	Off	Off	Off	0	C	0	0	0	0
0	1	0	Off	Off	On	Off	Off	Off	0	0	C	0	0	0
1	1	0	Off	Off	Off	On	Off	Off	0	0	0	C	0	0
0	0	1	Off	Off	Off	Off	On	Off	0	0	0	0	C	0
1	0	1	Off	Off	Off	Off	Off	On	0	0	0	0	0	C
1	1	1	Off	Off	Off	Off	Off	Off	0	0	0	0	0	0

TRUTH TABLE Normally Open
CCS-18NX7C-T

Logic Input							RF Path							Indicator Switches						
1	2	3	4	5	6	7	J1	J2	J3	J4	J5	J6	J7	E	F	G	H	K	L	M
1	0	0	0	0	0	0	On	Off	Off	Off	Off	Off	Off	C	0	0	0	0	0	0
0	1	0	0	0	0	0	Off	On	Off	Off	Off	Off	Off	0	C	0	0	0	0	0
0	0	1	0	0	0	0	Off	Off	On	Off	Off	Off	Off	0	0	C	0	0	0	0
0	0	0	1	0	0	0	Off	Off	Off	On	Off	Off	Off	0	0	0	C	0	0	0
0	0	0	0	1	0	0	Off	Off	Off	Off	On	Off	Off	0	0	0	0	C	0	0
0	0	0	0	0	1	0	Off	Off	Off	Off	Off	On	Off	0	0	0	0	0	C	0
0	0	0	0	0	0	1	Off	Off	Off	Off	Off	Off	On	0	0	0	0	0	0	C

TRUTH TABLE Normally Open
CCS-18NX7C-TD

Logic Input			RF Path							Indicator Switches						
1	2	3	J1	J2	J3	J4	J5	J6	J7	E	F	G	H	K	L	M
0	0	0	On	Off	Off	Off	Off	Off	Off	C	0	0	0	0	0	0
1	0	0	Off	On	Off	Off	Off	Off	Off	0	C	0	0	0	0	0
0	1	0	Off	Off	On	Off	Off	Off	Off	0	0	C	0	0	0	0
1	1	0	Off	Off	Off	On	Off	Off	Off	0	0	0	C	0	0	0
0	0	1	Off	Off	Off	Off	On	Off	Off	0	0	0	0	C	0	0
1	0	1	Off	Off	Off	Off	Off	On	Off	0	0	0	0	0	C	0
0	1	1	Off	Off	Off	Off	Off	Off	On	0	0	0	0	0	0	C
1	1	1	Off	Off	Off	Off	Off	Off	Off	0	0	0	0	0	0	0

TRUTH TABLE Normally Open
CCS-18NX8C-T

Logic Input								RF Path								Indicator Switches							
1	2	3	4	5	6	7	8	J1	J2	J3	J4	J5	J6	J7	J8	E	F	G	H	K	L	M	N
1	0	0	0	0	0	0	0	On	Off	Off	Off	Off	Off	Off	Off	C	0	0	0	0	0	0	0
0	1	0	0	0	0	0	0	Off	On	Off	Off	Off	Off	Off	Off	0	C	0	0	0	0	0	0
0	0	1	0	0	0	0	0	Off	Off	On	Off	Off	Off	Off	Off	0	0	C	0	0	0	0	0
0	0	0	1	0	0	0	0	Off	Off	Off	On	Off	Off	Off	Off	0	0	0	C	0	0	0	0
0	0	0	0	1	0	0	0	Off	Off	Off	Off	On	Off	Off	Off	0	0	0	0	C	0	0	0
0	0	0	0	0	1	0	0	Off	Off	Off	Off	Off	On	Off	Off	0	0	0	0	0	C	0	0
0	0	0	0	0	0	1	0	Off	Off	Off	Off	Off	Off	On	Off	0	0	0	0	0	0	C	0
0	0	0	0	0	0	0	1	Off	Off	Off	Off	Off	Off	Off	On	0	0	0	0	0	0	0	C

TRUTH TABLE Normally Open
CCS-18NX8C-TD

Logic Input				RF Path								Indicator Switches							
1	2	3	4	J1	J2	J3	J4	J5	J6	J7	J8	E	F	G	H	K	L	M	N
0	0	0	0	On	Off	Off	Off	Off	Off	Off	Off	C	0	0	0	0	0	0	0
1	0	0	0	Off	On	Off	Off	Off	Off	Off	Off	0	C	0	0	0	0	0	0
0	1	0	0	Off	Off	On	Off	Off	Off	Off	Off	0	0	C	0	0	0	0	0
1	1	0	0	Off	Off	Off	On	Off	Off	Off	Off	0	0	0	C	0	0	0	0
0	0	1	0	Off	Off	Off	Off	On	Off	Off	Off	0	0	0	0	C	0	0	0
1	0	1	0	Off	Off	Off	Off	Off	On	Off	Off	0	0	0	0	0	C	0	0
0	1	1	0	Off	Off	Off	Off	Off	Off	On	Off	0	0	0	0	0	0	C	0
1	1	1	1	Off	Off	Off	Off	Off	Off	Off	On	0	0	0	0	0	0	0	C
1	1	1	0	Off	Off	Off	Off	Off	Off	Off	Off	0	0	0	0	0	0	0	0

TYPICAL NARROWBAND RF INSERTION LOSS PERFORMANCE CURVES

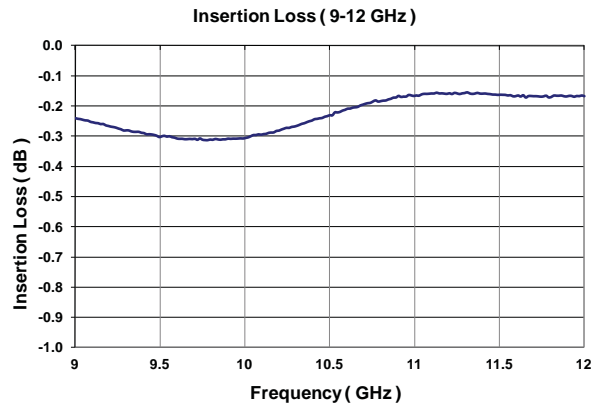
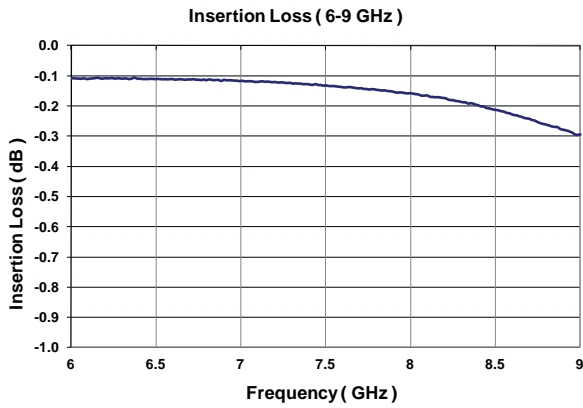
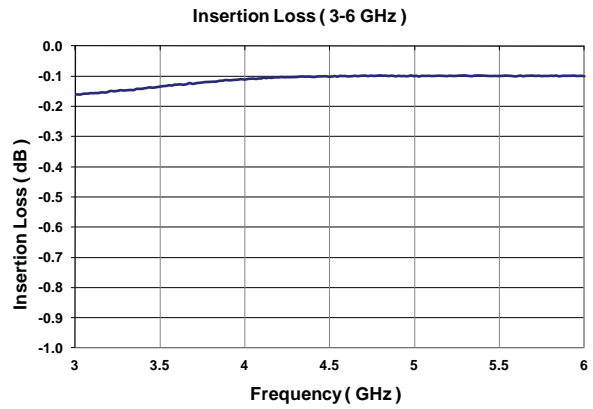
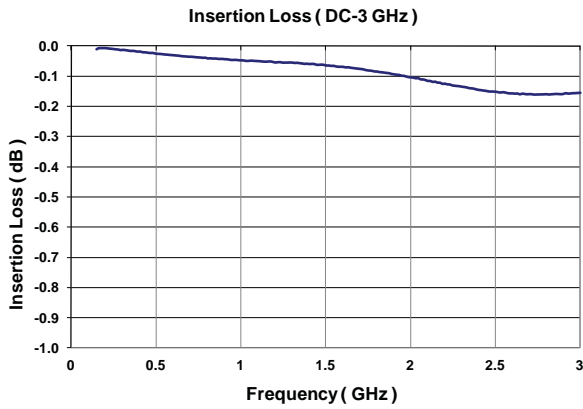

RF NOTES

TYPICAL NARROWBAND RF ISOLATION PERFORMANCE CURVES

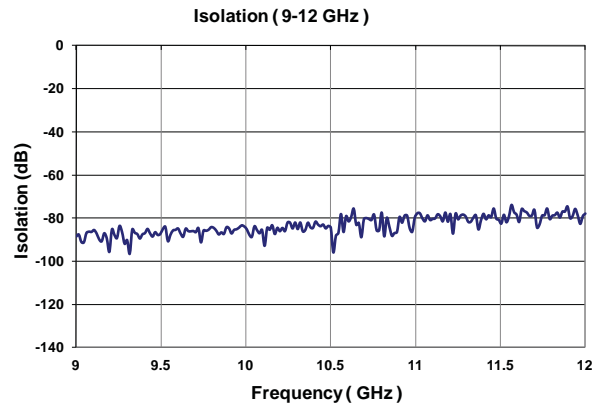
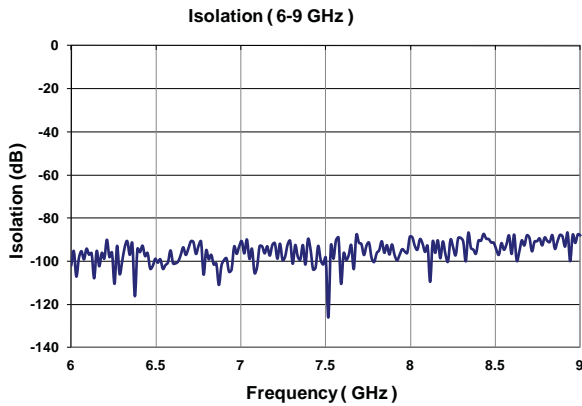
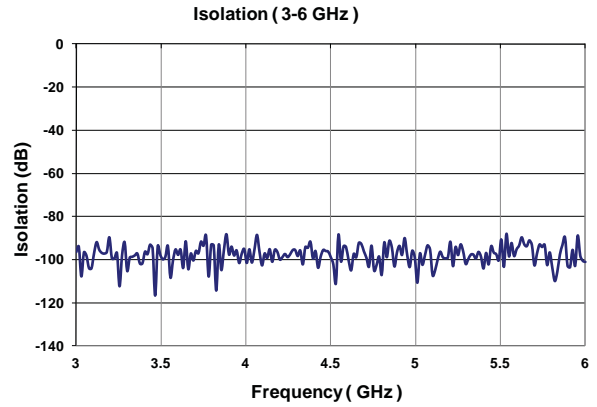
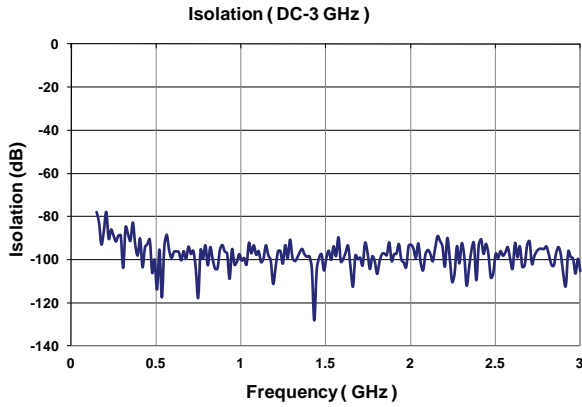

RF NOTES

TYPICAL NARROWBAND RF VSWR PERFORMANCE CURVES

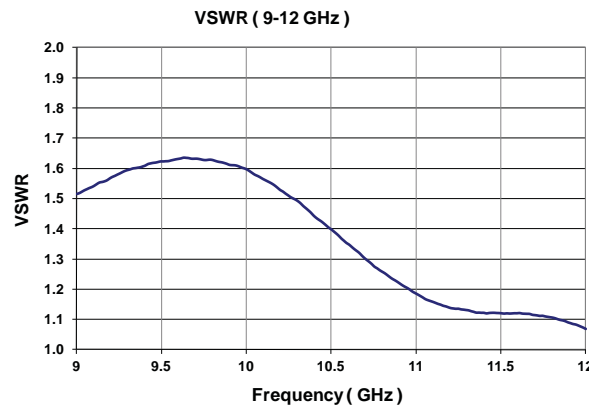
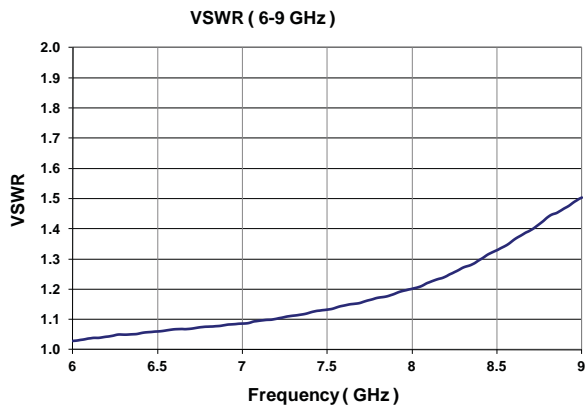
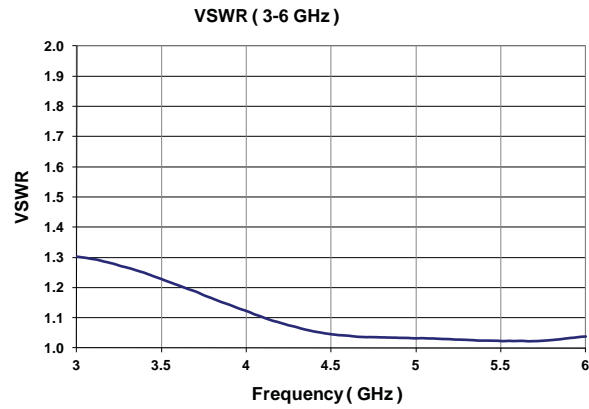
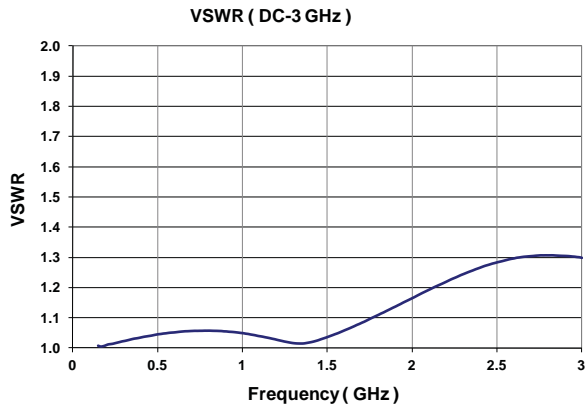

RF NOTES

TYPICAL POWER PERFORMANCE CURVE

Power Handling vs. Frequency

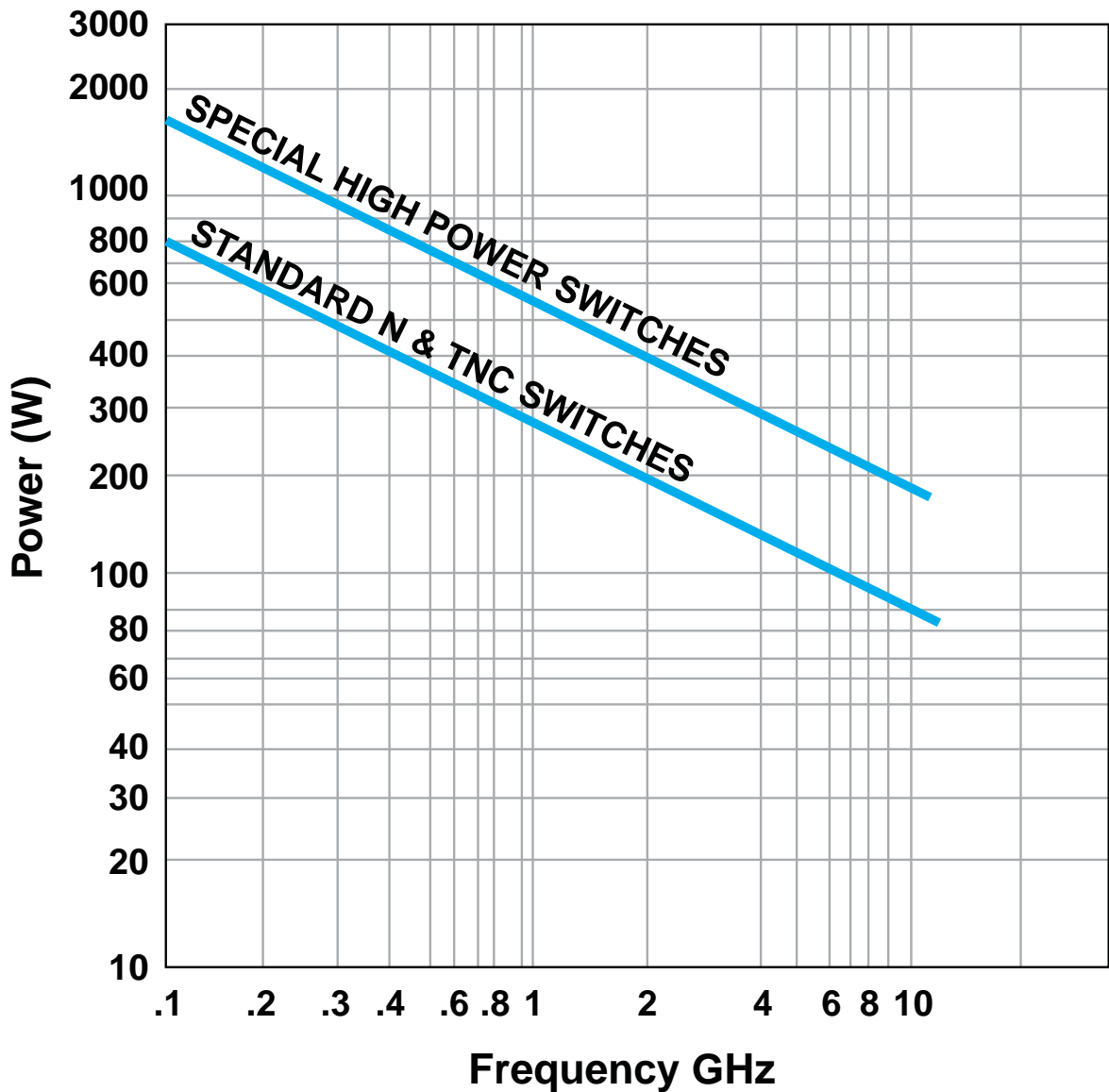

Estimates based on the following reference conditions:

- Ambient temperature of 40°C or less
- Sea level operation
- Load VSWR of 1.20:1 maximum
- No high-power (hot) switching

Please contact Teledyne Coax Switches for derating factors when applications do not meet the foregoing reference conditions.

GLOSSARY

Actuator

An actuator is the electromechanical mechanism that transfers the RF contacts from one position to another upon DC command.

Arc Suppression Diode

A diode is connected in parallel with the coil. This diode limits the “reverse EMF spike” generated when the coil de-energizes to 0.7 volts. The diode cathode is connected to the positive side of the coil and the anode is connected to the negative side.

Date Code

All switches are marked with either a unique serial number or a date code. Date codes are in accordance with MIL-STD-1285 Paragraph 5.2.5 and consist of four digits. The first two digits define the year and the last two digits define the week of the year (YYWW). Thus, 1032 identifies switches that passed through final inspection during the 32nd week of 2010.

Indicator

Indicators tell the system which position the switch is in. Other names for indicators are telemetry contacts or tellback circuit. Indicators are usually a set of internally mounted DC contacts linked to the actuator. They can be wired to digital input lines, status lights, or interlocks. Unless otherwise specified, the maximum indicator contact rating is 30 Vdc, 50 mA, or 1.5 Watts into a resistive load.

Isolation

Isolation is the measure of the power level at the output connector of an unconnected RF channel as referenced to the power at the input connector. It is specified in dB below the input power level.

Multi-Throw Switch

A multi-throw switch is a switch with one input and three or more output ports. The CCS-18 can switch a microwave signal to any of 2,3,4,5 or 6 output from a single common input.

Switching Time

Switching time is the total interval beginning with the arrival of the leading edge of the command pulse at the switch DC input and ending with the completion of the switch transfer, including contact bounce. It consists of three parts: (1) inductive delay in the coil, (2) transfer time of the physical movement of the contacts, and (3) the bounce time of the RF contacts.

TTL Switch Driver Option

As a special option, switch drivers can be provided for both failsafe and latching switches, which are compatible with industry-standard low-power Schottky TTL circuits.

TD-Option

This option includes a decoder. The 3-bit parallel command is decoded to internally select the appropriate position. See the logic tables. The TD-Option increases the Vsw supply current demand by 50mA max at 28Vdc and +20°C.

Performance Parameters vs Frequency

Generally speaking, the RF performance of coaxial switches is frequency dependent. With increasing frequency, VSWR and insertion loss increase while isolation decreases. All data sheets specify these three parameters as “worst case” at the highest operating frequency. If the switch is to be used over a narrow frequency band, better performance can be achieved.

Actuator Current vs Temperature

The resistance of the actuator coil varies as a function of temperature. There is an inverse relationship between the operating temperature of the switch and the actuator drive current. For switches operating at 28 VDC, the approximate actuator drive current at temperature, T, can be calculated using the equation:

$$I_T = \frac{I_A}{[1 + .00385 (T-20)]}$$

Where:

I_T = Actuator current at temperature, T

I_A = Room temperature actuator current – see data sheet

T = Temperature of interest in °C

Magnetic Sensitivity

An electro-mechanical switch can be sensitive to ferrous materials and external magnetic fields. Neighboring ferrous materials should be permitted no closer than 0.5 inches and adjacent external magnetic fields should be limited to a flux density of less than 5 Gauss.

SPECIAL FEATURE

Switching High-Power or Highly Sensitive Signals

Ensure the most linear response with the best galvanically matched contact system in the industry. Extremely low passive intermodulation is standard on all of our switches.

Carrier Frequency 1	Carrier Frequency 2	PIM 3rd Order Frequency	PIM 5th Order Frequency
870 MHz	893 MHz	847 MHz	824 MHz

	3rd Order Intermodulation	5th Order Intermodulation
Multiple Positions	-96 dBm	-115 dBm
	-139 dBc	-158 dBc

NORMALLY OPEN CCS-18N/CS-18N • CCS-18T/CS-18T PART NUMBER LIST

	PART No.		PART No.		PART No.		PART No.
1	CCS-18NX3C	43	CS-18NX30	85	CS-18NX4C	127	CCS-18NX50
2	CCS-18NX3C-D	44	CS-18NX30-D	86	CS-18NX4C-D	128	CCS-18NX50-D
3	CCS-18NX3C-DM	45	CS-18NX30-DM	87	CS-18NX4C-DM	129	CCS-18NX50-DM
4	CCS-18NX3C-M	46	CS-18NX30-M	88	CS-18NX4C-M	130	CCS-18NX50-M
5	CCS-18NX3C-MS	47	CS-18NX30-MS	89	CS-18NX4C-MS	131	CCS-18NX50-MS
6	CCS-18NX3C-S	48	CS-18NX30-S	90	CS-18NX4C-S	132	CCS-18NX50-S
7	CCS-18NX3C-T	49	CS-18NX30-T	91	CS-18NX4C-T	133	CCS-18NX50-T
8	CCS-18NX3C-TD	50	CS-18NX30-TD	92	CS-18NX4C-TD	134	CCS-18NX50-TD
9	CCS-18NX3C-TDM	51	CS-18NX30-TDM	93	CS-18NX4C-TDM	135	CCS-18NX50-TDM
10	CCS-18NX3C-TDMS	52	CS-18NX30-TDMS	94	CS-18NX4C-TDMS	136	CCS-18NX50-TDMS
11	CCS-18NX3C-TDS	53	CS-18NX30-TDS	95	CS-18NX4C-TDS	137	CCS-18NX50-TDS
12	CCS-18NX3C-TM	54	CS-18NX30-TM	96	CS-18NX4C-TM	138	CCS-18NX50-TM
13	CCS-18NX3C-TMS	55	CS-18NX30-TMS	97	CS-18NX4C-TMS	139	CCS-18NX50-TMS
14	CCS-18NX3C-TS	56	CS-18NX30-TS	98	CS-18NX4C-TS	140	CCS-18NX50-TS
15	CCS-18NX30	57	CCS-18NX4C	99	CS-18NX40	141	CS-18NX5C
16	CCS-18NX30-D	58	CCS-18NX4C-D	100	CS-18NX40-D	142	CS-18NX5C-D
17	CCS-18NX30-DM	59	CCS-18NX4C-DM	101	CS-18NX40-DM	143	CS-18NX5C-DM
18	CCS-18NX30-M	60	CCS-18NX4C-M	102	CS-18NX40-M	144	CS-18NX5C-M
19	CCS-18NX30-MS	61	CCS-18NX4C-MS	103	CS-18NX40-MS	145	CS-18NX5C-MS
20	CCS-18NX30-S	62	CCS-18NX4C-S	104	CS-18NX40-S	146	CS-18NX5C-S
21	CCS-18NX30-T	63	CCS-18NX4C-T	105	CS-18NX40-T	147	CS-18NX5C-T
22	CCS-18NX30-TD	64	CCS-18NX4C-TD	106	CS-18NX40-TD	148	CS-18NX5C-TD
23	CCS-18NX30-TDM	65	CCS-18NX4C-TDM	107	CS-18NX40-TDM	149	CS-18NX5C-TDM
24	CCS-18NX30-TDMS	66	CCS-18NX4C-TDMS	108	CS-18NX40-TDMS	150	CS-18NX5C-TDMS
25	CCS-18NX30-TDS	67	CCS-18NX4C-TDS	109	CS-18NX40-TDS	151	CS-18NX5C-TDS
26	CCS-18NX30-TM	68	CCS-18NX4C-TM	110	CS-18NX40-TM	152	CS-18NX5C-TM
27	CCS-18NX30-TMS	69	CCS-18NX4C-TMS	111	CS-18NX40-TMS	153	CS-18NX5C-TMS
28	CCS-18NX30-TS	70	CCS-18NX4C-TS	112	CS-18NX40-TS	154	CS-18NX5C-TS
29	CS-18NX3C	71	CCS-18NX40	113	CCS-18NX5C	155	CS-18NX50
30	CS-18NX3C-D	72	CCS-18NX40-D	114	CCS-18NX5C-D	156	CS-18NX50-D
31	CS-18NX3C-DM	73	CCS-18NX40-DM	115	CCS-18NX5C-DM	157	CS-18NX50-DM
32	CS-18NX3C-M	74	CCS-18NX40-M	116	CCS-18NX5C-M	158	CS-18NX50-M
33	CS-18NX3C-MS	75	CCS-18NX40-MS	117	CCS-18NX5C-MS	159	CS-18NX50-MS
34	CS-18NX3C-S	76	CCS-18NX40-S	118	CCS-18NX5C-S	160	CS-18NX50-S
35	CS-18NX3C-T	77	CCS-18NX40-T	119	CCS-18NX5C-T	161	CS-18NX50-T
36	CS-18NX3C-TD	78	CCS-18NX40-TD	120	CCS-18NX5C-TD	162	CS-18NX50-TD
37	CS-18NX3C-TDM	79	CCS-18NX40-TDM	121	CCS-18NX5C-TDM	163	CS-18NX50-TDM
38	CS-18NX3C-TDMS	80	CCS-18NX40-TDMS	122	CCS-18NX5C-TDMS	164	CS-18NX50-TDMS
39	CS-18NX3C-TDS	81	CCS-18NX40-TDS	123	CCS-18NX5C-TDS	165	CS-18NX50-TDS
40	CS-18NX3C-TM	82	CCS-18NX40-TM	124	CCS-18NX5C-TM	166	CS-18NX50-TM
41	CS-18NX3C-TMS	83	CCS-18NX40-TMS	125	CCS-18NX5C-TMS	167	CS-18NX50-TMS
42	CS-18NX3C-TS	84	CCS-18NX40-TS	126	CCS-18NX5C-TS	168	CS-18NX50-TS

* X = 1 (28Vdc), 2 (15Vdc), 3 (12Vdc) and 4 (24Vdc)

Series CCS-18/CS-18
High Power Multi-Throw DC–12 GHz
Normally Open Coaxial Switch



NORMALLY OPEN CCS-18N/CS-18N • CCS-18T/CS-18T PART NUMBER LIST

	PART No.		PART No.		PART No.		PART No.
169	CCS-18NX6C	211	CS-18NX60	253	CS-18NX7C	295	CCS-18NX80
170	CCS-18NX6C-D	212	CS-18NX60-D	254	CS-18NX7C-D	296	CCS-18NX80-D
171	CCS-18NX6C-DM	213	CS-18NX60-DM	255	CS-18NX7C-DM	297	CCS-18NX80-DM
172	CCS-18NX6C-M	214	CS-18NX60-M	256	CS-18NX7C-M	298	CCS-18NX80-M
173	CCS-18NX6C-MS	215	CS-18NX60-MS	257	CS-18NX7C-MS	299	CCS-18NX80-MS
174	CCS-18NX6C-S	216	CS-18NX60-S	258	CS-18NX7C-S	300	CCS-18NX80-S
175	CCS-18NX6C-T	217	CS-18NX60-T	259	CS-18NX7C-T	301	CCS-18NX80-T
176	CCS-18NX6C-TD	218	CS-18NX60-TD	260	CS-18NX7C-TD	302	CCS-18NX80-TD
177	CCS-18NX6C-TDM	219	CS-18NX60-TDM	261	CS-18NX7C-TDM	303	CCS-18NX80-TDM
178	CCS-18NX6C-TDMS	220	CS-18NX60-TDMS	262	CS-18NX7C-TDMS	304	CCS-18NX80-TDMS
179	CCS-18NX6C-TDS	221	CS-18NX60-TDS	263	CS-18NX7C-TDS	305	CCS-18NX80-TDS
180	CCS-18NX6C-TM	222	CS-18NX60-TM	264	CS-18NX7C-TM	306	CCS-18NX80-TM
181	CCS-18NX6C-TMS	223	CS-18NX60-TMS	265	CS-18NX7C-TMS	307	CCS-18NX80-TMS
182	CCS-18NX6C-TS	224	CS-18NX60-TS	266	CS-18NX7C-TS	308	CCS-18NX80-TS
183	CCS-18NX60	225	CCS-18NX7C	267	CS-18NX70	309	CS-18NX8C
184	CCS-18NX60-D	226	CCS-18NX7C-D	268	CS-18NX70-D	310	CS-18NX8C-D
185	CCS-18NX60-DM	227	CCS-18NX7C-DM	269	CS-18NX70-DM	311	CS-18NX8C-DM
186	CCS-18NX60-M	228	CCS-18NX7C-M	270	CS-18NX70-M	312	CS-18NX8C-M
187	CCS-18NX60-MS	229	CCS-18NX7C-MS	271	CS-18NX70-MS	313	CS-18NX8C-MS
188	CCS-18NX60-S	230	CCS-18NX7C-S	272	CS-18NX70-S	314	CS-18NX8C-S
189	CCS-18NX60-T	231	CCS-18NX7C-T	273	CS-18NX70-T	315	CS-18NX8C-T
190	CCS-18NX60-TD	232	CCS-18NX7C-TD	274	CS-18NX70-TD	316	CS-18NX8C-TD
191	CCS-18NX60-TDM	233	CCS-18NX7C-TDM	275	CS-18NX70-TDM	317	CS-18NX8C-TDM
192	CCS-18NX60-TDMS	234	CCS-18NX7C-TDMS	276	CS-18NX70-TDMS	318	CS-18NX8C-TDMS
193	CCS-18NX60-TDS	235	CCS-18NX7C-TDS	277	CS-18NX70-TDS	319	CS-18NX8C-TDS
194	CCS-18NX60-TM	236	CCS-18NX7C-TM	278	CS-18NX70-TM	320	CS-18NX8C-TM
195	CCS-18NX60-TMS	237	CCS-18NX7C-TMS	279	CS-18NX70-TMS	321	CS-18NX8C-TMS
196	CCS-18NX60-TS	238	CCS-18NX7C-TS	280	CS-18NX70-TS	322	CS-18NX8C-TS
197	CS-18NX6C	239	CCS-18NX70	281	CCS-18NX8C	323	CS-18NX80
198	CS-18NX6C-D	240	CCS-18NX70-D	282	CCS-18NX8C-D	324	CS-18NX80-D
199	CS-18NX6C-DM	241	CCS-18NX70-DM	283	CCS-18NX8C-DM	325	CS-18NX80-DM
200	CS-18NX6C-M	242	CCS-18NX70-M	284	CCS-18NX8C-M	326	CS-18NX80-M
201	CS-18NX6C-MS	243	CCS-18NX70-MS	285	CCS-18NX8C-MS	327	CS-18NX80-MS
202	CS-18NX6C-S	244	CCS-18NX70-S	286	CCS-18NX8C-S	328	CS-18NX80-S
203	CS-18NX6C-T	245	CCS-18NX70-T	287	CCS-18NX8C-T	329	CS-18NX80-T
204	CS-18NX6C-TD	246	CCS-18NX70-TD	288	CCS-18NX8C-TD	330	CS-18NX80-TD
205	CS-18NX6C-TDM	247	CCS-18NX70-TDM	289	CCS-18NX8C-TDM	331	CS-18NX80-TDM
206	CS-18NX6C-TDMS	248	CCS-18NX70-TDMS	290	CCS-18NX8C-TDMS	332	CS-18NX80-TDMS
207	CS-18NX6C-TDS	249	CCS-18NX70-TDS	291	CCS-18NX8C-TDS	333	CS-18NX80-TDS
208	CS-18NX6C-TM	250	CCS-18NX70-TM	292	CCS-18NX8C-TM	334	CS-18NX80-TM
209	CS-18NX6C-TMS	251	CCS-18NX70-TMS	293	CCS-18NX8C-TMS	335	CS-18NX80-TMS
210	CS-18NX6C-TS	252	CCS-18NX70-TS	294	CCS-18NX8C-TS	336	CS-18NX80-TS

* X = 1 (28Vdc), 2 (15Vdc), 3 (12Vdc) and 4 (24Vdc)

NORMALLY OPEN CCS-18N/CS-18N • CCS-18T/CS-18T PART NUMBER LIST

	PART No.		PART No.		PART No.		PART No.
337	CCS-18TX3C	379	CS-18TX30	421	CS-18TX4C	463	CCS-18TX50
338	CCS-18TX3C-D	380	CS-18TX30-D	422	CS-18TX4C-D	464	CCS-18TX50-D
339	CCS-18TX3C-DM	381	CS-18TX30-DM	423	CS-18TX4C-DM	465	CCS-18TX50-DM
340	CCS-18TX3C-M	382	CS-18TX30-M	424	CS-18TX4C-M	466	CCS-18TX50-M
341	CCS-18TX3C-MS	383	CS-18TX30-MS	425	CS-18TX4C-MS	467	CCS-18TX50-MS
342	CCS-18TX3C-S	384	CS-18TX30-S	426	CS-18TX4C-S	468	CCS-18TX50-S
343	CCS-18TX3C-T	385	CS-18TX30-T	427	CS-18TX4C-T	469	CCS-18TX50-T
344	CCS-18TX3C-TD	386	CS-18TX30-TD	428	CS-18TX4C-TD	470	CCS-18TX50-TD
345	CCS-18TX3C-TDM	387	CS-18TX30-TDM	429	CS-18TX4C-TDM	471	CCS-18TX50-TDM
346	CCS-18TX3C-TDMS	388	CS-18TX30-TDMS	430	CS-18TX4C-TDMS	472	CCS-18TX50-TDMS
347	CCS-18TX3C-TDS	389	CS-18TX30-TDS	431	CS-18TX4C-TDS	473	CCS-18TX50-TDS
348	CCS-18TX3C-TM	390	CS-18TX30-TM	432	CS-18TX4C-TM	474	CCS-18TX50-TM
349	CCS-18TX3C-TMS	391	CS-18TX30-TMS	433	CS-18TX4C-TMS	475	CCS-18TX50-TMS
350	CCS-18TX3C-TS	392	CS-18TX30-TS	434	CS-18TX4C-TS	476	CCS-18TX50-TS
351	CCS-18TX30	393	CCS-18TX4C	435	CS-18TX40	477	CS-18TX5C
352	CCS-18TX30-D	394	CCS-18TX4C-D	436	CS-18TX40-D	478	CS-18TX5C-D
353	CCS-18TX30-DM	395	CCS-18TX4C-DM	437	CS-18TX40-DM	479	CS-18TX5C-DM
354	CCS-18TX30-M	396	CCS-18TX4C-M	438	CS-18TX40-M	480	CS-18TX5C-M
355	CCS-18TX30-MS	397	CCS-18TX4C-MS	439	CS-18TX40-MS	481	CS-18TX5C-MS
356	CCS-18TX30-S	398	CCS-18TX4C-S	440	CS-18TX40-S	482	CS-18TX5C-S
357	CCS-18TX30-T	399	CCS-18TX4C-T	441	CS-18TX40-T	483	CS-18TX5C-T
358	CCS-18TX30-TD	400	CCS-18TX4C-TD	442	CS-18TX40-TD	484	CS-18TX5C-TD
359	CCS-18TX30-TDM	401	CCS-18TX4C-TDM	443	CS-18TX40-TDM	485	CS-18TX5C-TDM
360	CCS-18TX30-TDMS	402	CCS-18TX4C-TDMS	444	CS-18TX40-TDMS	486	CS-18TX5C-TDMS
361	CCS-18TX30-TDS	403	CCS-18TX4C-TDS	445	CS-18TX40-TDS	487	CS-18TX5C-TDS
362	CCS-18TX30-TM	404	CCS-18TX4C-TM	446	CS-18TX40-TM	488	CS-18TX5C-TM
363	CCS-18TX30-TMS	405	CCS-18TX4C-TMS	447	CS-18TX40-TMS	489	CS-18TX5C-TMS
364	CCS-18TX30-TS	406	CCS-18TX4C-TS	448	CS-18TX40-TS	490	CS-18TX5C-TS
365	CS-18TX3C	407	CCS-18TX40	449	CCS-18TX5C	491	CS-18TX50
366	CS-18TX3C-D	408	CCS-18TX40-D	450	CCS-18TX5C-D	492	CS-18TX50-D
367	CS-18TX3C-DM	409	CCS-18TX40-DM	451	CCS-18TX5C-DM	493	CS-18TX50-DM
368	CS-18TX3C-M	410	CCS-18TX40-M	452	CCS-18TX5C-M	494	CS-18TX50-M
369	CS-18TX3C-MS	411	CCS-18TX40-MS	453	CCS-18TX5C-MS	495	CS-18TX50-MS
370	CS-18TX3C-S	412	CCS-18TX40-S	454	CCS-18TX5C-S	496	CS-18TX50-S
371	CS-18TX3C-T	413	CCS-18TX40-T	455	CCS-18TX5C-T	497	CS-18TX50-T
372	CS-18TX3C-TD	414	CCS-18TX40-TD	456	CCS-18TX5C-TD	498	CS-18TX50-TD
373	CS-18TX3C-TDM	415	CCS-18TX40-TDM	457	CCS-18TX5C-TDM	499	CS-18TX50-TDM
374	CS-18TX3C-TDMS	416	CCS-18TX40-TDMS	458	CCS-18TX5C-TDMS	500	CS-18TX50-TDMS
375	CS-18TX3C-TDS	417	CCS-18TX40-TDS	459	CCS-18TX5C-TDS	501	CS-18TX50-TDS
376	CS-18TX3C-TM	418	CCS-18TX40-TM	460	CCS-18TX5C-TM	502	CS-18TX50-TM
377	CS-18TX3C-TMS	419	CCS-18TX40-TMS	461	CCS-18TX5C-TMS	503	CS-18TX50-TMS
378	CS-18TX3C-TS	420	CCS-18TX40-TS	462	CCS-18TX5C-TS	504	CS-18TX50-TS

* X = 1 (28Vdc), 2 (15Vdc), 3 (12Vdc) and 4 (24Vdc)