

PART NUMBER	DESCRIPTION
CCS-37K	Commercial Failsafe TRANSFER, DC-40GHz
CS-37K	Elite Failsafe TRANSFER, DC-40GHz

The CCS-37K/CS-37K is a long-life high performance transfer switch designed for use in 50 Ohms coaxial transmission lines operating over frequencies ranging from DC to 40GHz. The switch is designed for minimum size compatible with K connector spacing.

The failsafe switches on this page are provided with a spring operated actuator which is particularly desirable in applications where the switch is connected to one position (normally closed) most of the time and only periodically switched to the alternate position. In this type of application, holding power is required only when operating in the alternate position. Also, switching circuitry is simplified, since only one DC circuit is required.



ENVIRONMENTAL AND PHYSICAL CHARACTERISTICS	
Operating Temperature	
Commercial Model, CCS-37K	-25°C to 65°C
Elite Model, CS-37K	-55°C to 85°C
Vibration (MIL-STD-202 Method 214, Condition D, non-operating)	10 g's RMS
Shock (MIL-STD-202 Method 213, Condition D, non-operating)	500 g's
Standard Actuator Life	2,000,000 cycles
Connector Type	2.92 mm / K
Weight	3.0 oz. (70.87g) (max.)

ELECTRICAL CHARACTERISTICS	
Form Factor	TRANSFER, break before make
Frequency Range	
CCS-37K	DC-40 GHz
CS-37K	DC-40 GHz
Characteristic Impedance	50 Ohms
Operate Time	20 ms (max.)
Release Time	10 ms (max.)
Actuation Voltage Available	12 15 24 28 V
Actuation Current, max. @ ambient	800 650 700 400 mA

TYPICAL PERFORMANCE CHARACTERISTICS						
Frequency	DC-6 GHz	6-12 GHz	12-18 GHz	18-30GHz	30-33 GHz	33-40 GHz
Insertion Loss, dB, typical.	0.15	0.25	0.35	0.55	1.00	1.35
Isolation, dB, typical.	70	70	65	60	50	50
VSWR , typical.	1.15:1	1.20:1	1.25:1	1.50:1	2.00:1	2.50:1

**PART NUMBERING SYSTEM**

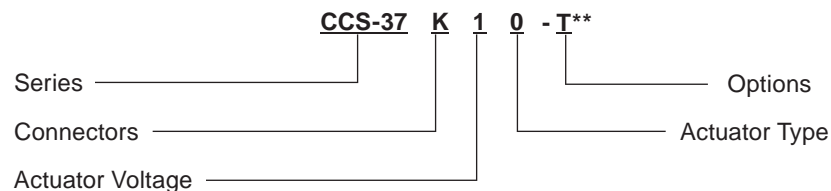

**Connector**  
K: 2.92 mm Female

**Actuator Voltage**  
1: 28 Vdc Failsafe  
2: 15 Vdc Failsafe  
3: 12 Vdc Failsafe  
4: 24 Vdc Failsafe

**Actuator Type**  
0: Standard Contacts  
C: Indicator Contacts

**Options**  
T: TTL Drivers with Diodes  
D: Transient Suppression Diodes  
M: Moisture Seal  
S: 9 Pin D-Sub Connector

**For other options, contact factory.**

**Series CCS-37K/CS-37K**  
 DC-40 GHz  
 Failsafe TRANSFER Coaxial Switch



**SCHEMATICS AND MECHANICAL OUTLINE**

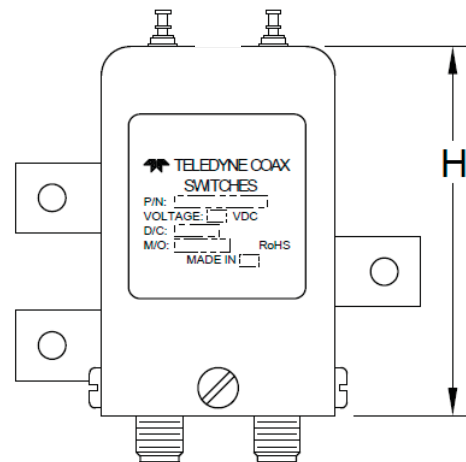
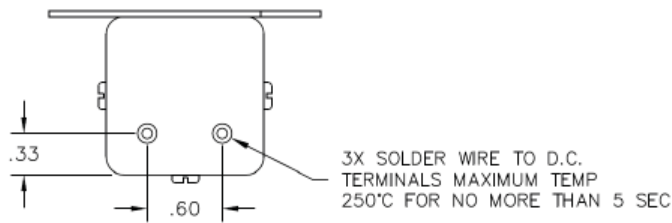
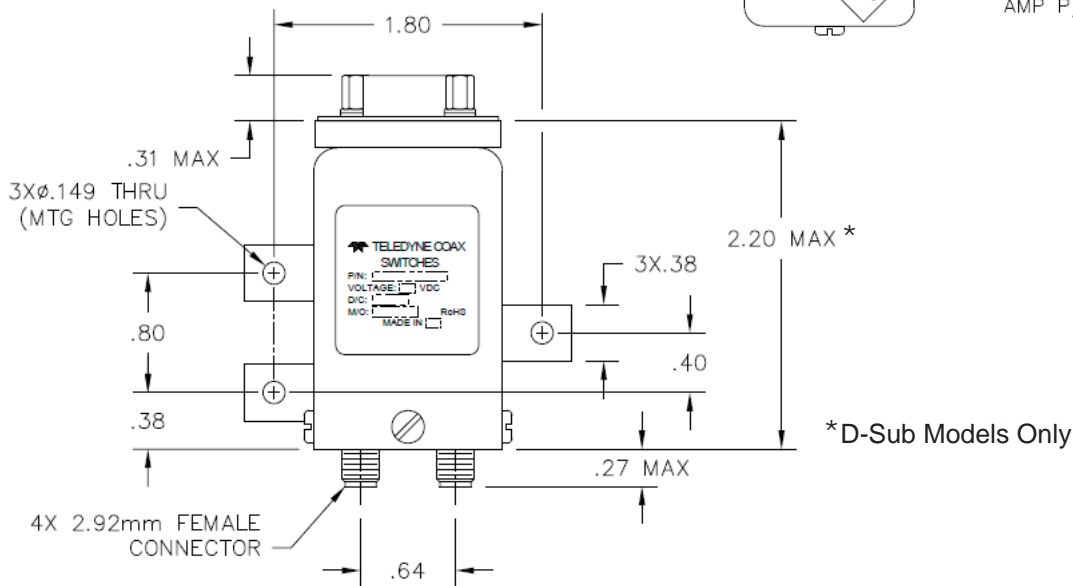
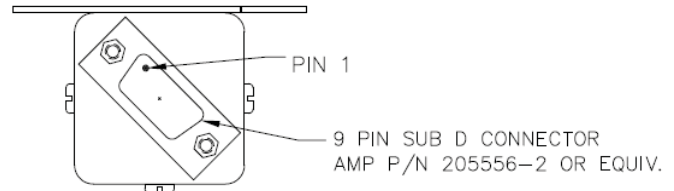
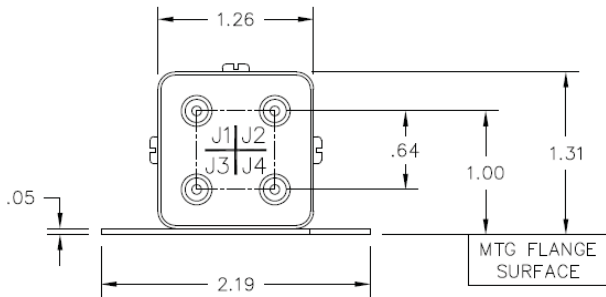

H=2.00 Max STD & Indicators Models  
 H=2.10 Max TTL Models

**SCHEMATICS AND MECHANICAL OUTLINE**

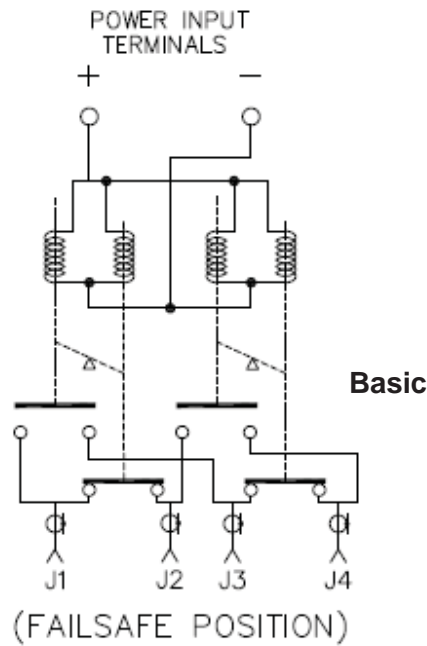

VOLTAGE	RF CONTINUITY
DE-ENERGIZED	J1-J2 & J3-J4
ENERGIZED	J1-J3 & J2-J4

9 PIN D-SUB PINOUT FOR FAILSAFE TRANSFER				
Pin No.	OPTIONS			
	Basic	Indicators	TTL	Indicators & TTL
1	+	+		
2	-	-		
3			Common	Common
4			1	1
5				
6			Vsw	Vsw
7		A		A
8		B		B
9		C		C

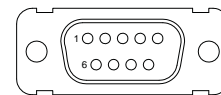

“-S OPTION” 9-PIN D-SUB CONNECTOR (EXAMPLE: CCS-37K10-S)

# Series CCS-37K/CS-37K

DC-40 GHz

Failsafe TRANSFER Coaxial Switch



**TELEDYNE**  
**COAX SWITCHES**  
Everywhereyoulook™

## TYPICAL RF PERFORMANCE CURVES

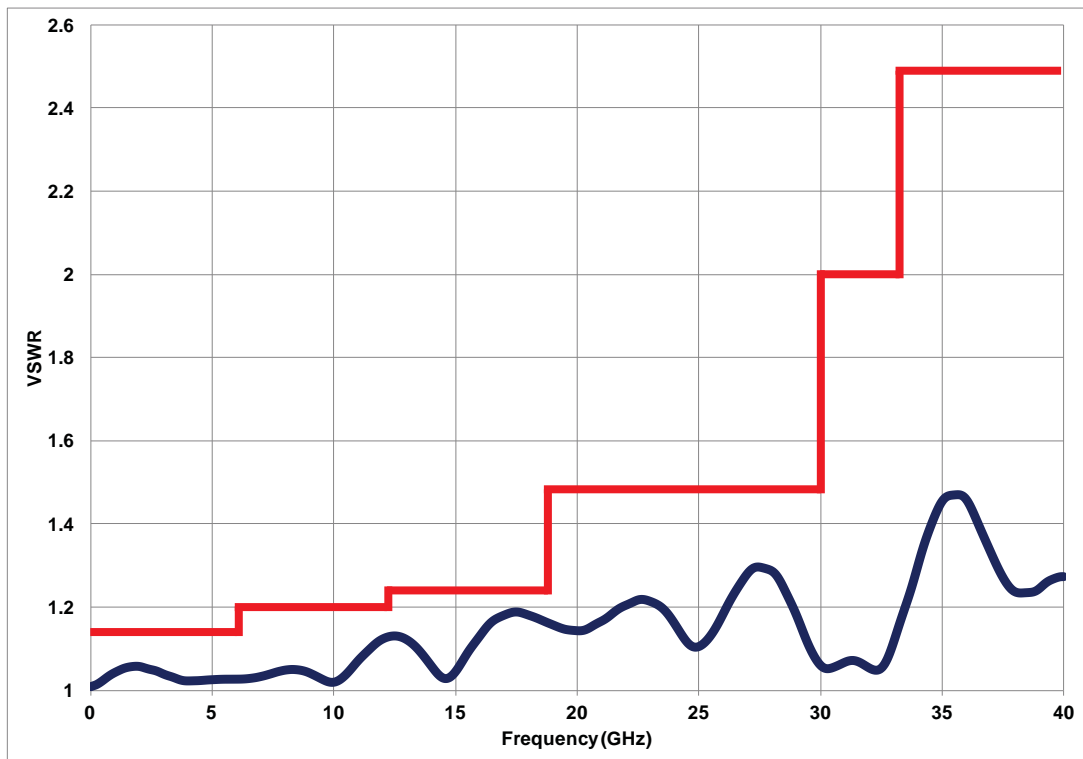
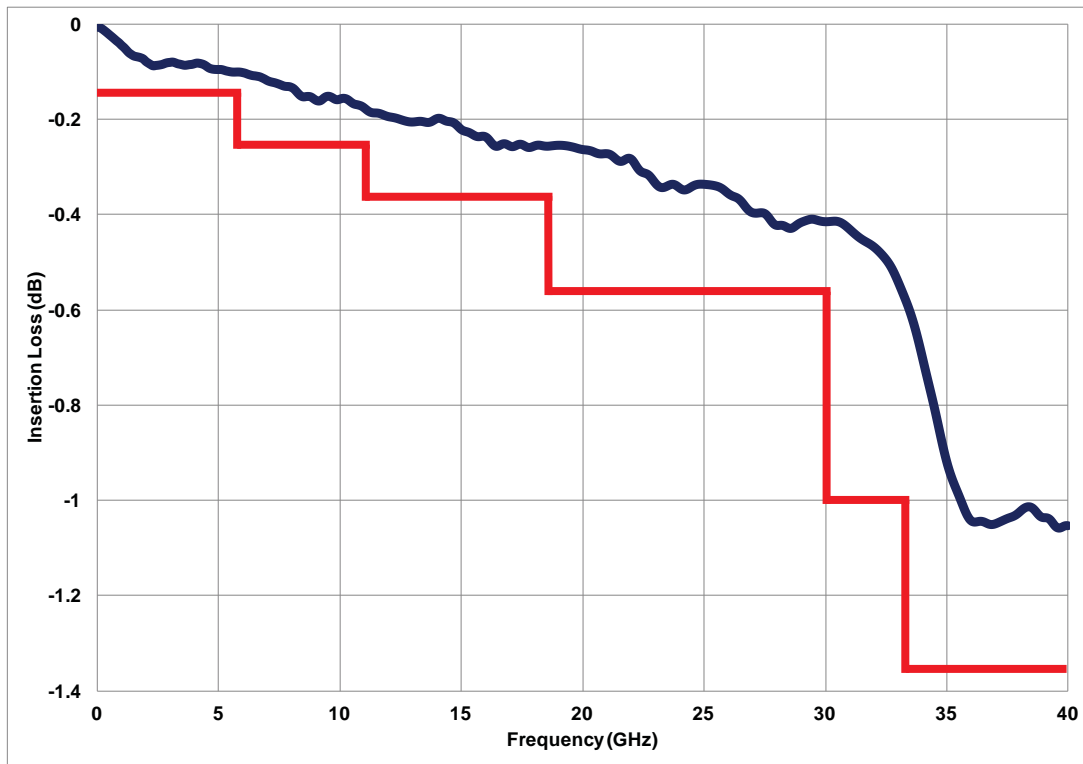

**TYPICAL RF PERFORMANCE CURVES**

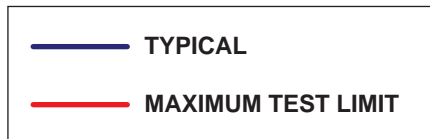
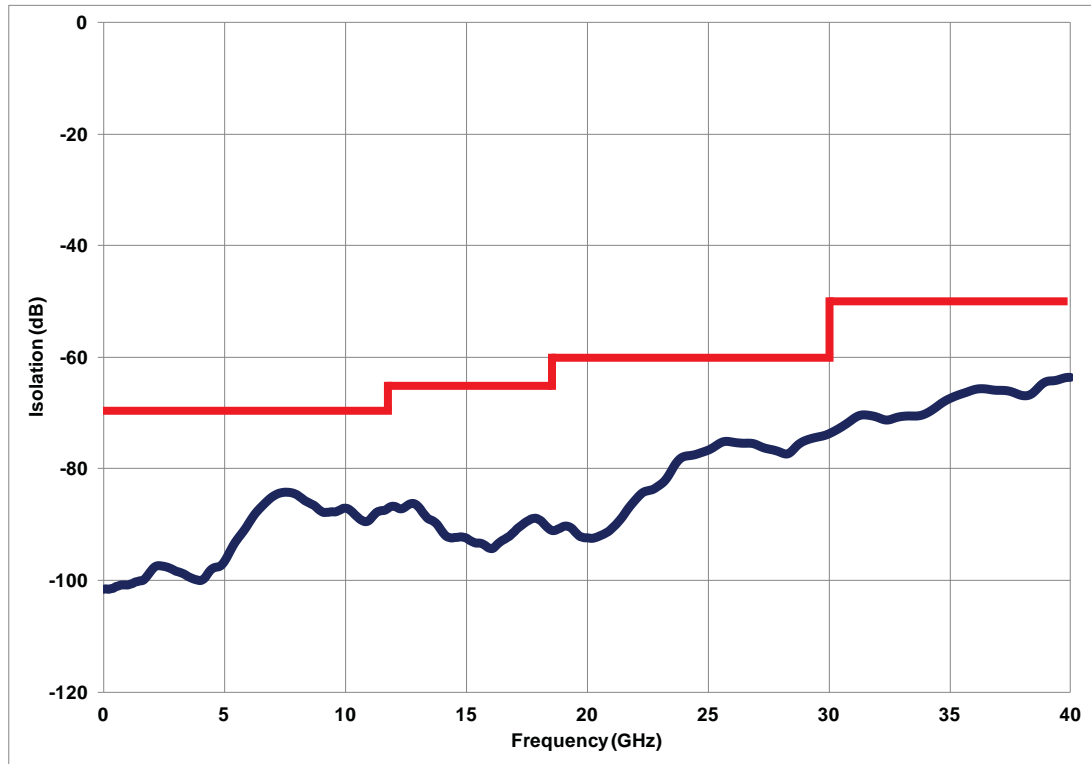

**TYPICAL POWER PERFORMANCE CURVE**

# Power Handling vs. Frequency

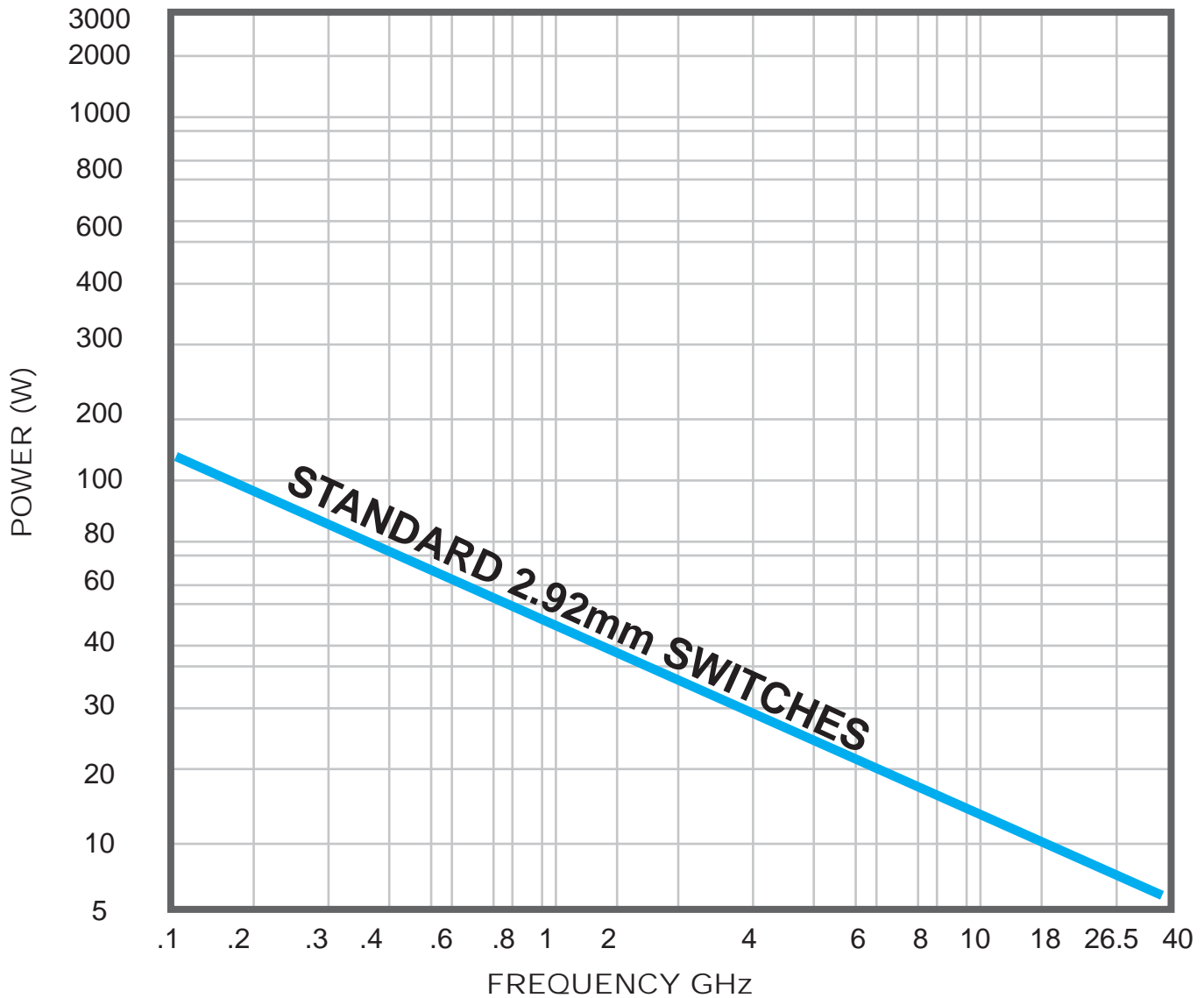

Estimates based on the following reference conditions:

- Ambient temperature of 40°C or less
- Sea level operation
- Load VSWR of 1.20:1 maximum
- No high-power (hot) switching

Please contact Teledyne Coax Switches for derating factors when applications do not meet the foregoing reference conditions.