

PART NUMBER	DESCRIPTION
CCT-49K	Commercial Latching Multi-throw, DC-40 GHz
CT-49K	Elite Latching Multi-throw, DC-40GHz

The CCT-49K/CT-49K is an Internally Terminated broadband, multi-throw, electromechanical coaxial switch designed to switch a microwave signal from a common input to any of 3, 4, 5, or 6 outputs. The characteristic impedance is 50 Ohms. Internal terminations provide an impedance match for the unselected ports. The switches are small using the popular connector spacing on a 1.062" dia. circle. Each position has an individual actuator mechanism allowing random position selection. This also minimizes switching time.

The CCT-49K/CT-49K comes with a latching actuator. The latching switch remains in the last position selected when the switch is de-energized. STD dual command requires a reset pulse before a new selected position. A separate reset circuit allows all positions to be set to an open position. User must provide both reset (clear) and set (select new position) commands.



RoHS Compliant

Available with USB & Ethernet Control!



Click here MMC SERIES

ENVIRONMENTAL AND PHYSICAL CHARACTERISTICS	
Operating Temperature	
Commercial Model, CCT-49K	-25°C to 65°C
Elite Model, CT-49K***	-55°C to 85°C
Vibration (MIL-STD-202 Method 214, Condition D, non-operating)	10 g's RMS
Shock (MIL-STD-202 Method 213, Condition D, non-operating)	500 g's
Standard Actuator Life	5,000,000 cycles
Actuator Life w/ Additional Features	1,000,000 cycles
Connector Type	2.92mm (K)
Humidity (Moisture Seal)	Available
Weight	6 oz. (170.1g) (max.)

ELECTRICAL CHARACTERISTICS	
Form Factor	Multi-Throw, break before make
Frequency Range	
CCT-49K	DC-40 GHz
CT-49K	DC-40 GHz
Characteristic Impedance	50 Ohms
Operate Time	20 ms (max.)
Terminations	50Ω
Actuation Voltage Available	12 15 24 28 V
Actuation Current	255 205 130 90 mA
Reset Current (# of Positions)	3 765 615 390 270 mA
	4 1020 820 520 360 mA
	5 1275 1025 650 450 mA
	6 1530 1230 780 540 mA

PERFORMANCE CHARACTERISTICS						
Frequency	DC-6 GHz	6-12 GHz	12-18 GHz	18-26.5 GHz	26.5-32 GHz	32-40 GHz
Insertion Loss, dB, max.	0.20	0.30	0.60	0.80	0.80	1.40
Isolation, dB, min.	80	75	70	70	60	60
VSWR , max.	1.25:1	1.30:1	1.60:1	1.70:1	1.80:1	1.95:1

For maximum limits, please see charts on pages 7-8

PART NUMBERING SYSTEM

CCT-49 K 6 6 C - I**

Series

Connectors

Actuator Voltage

Options

Actuator Type

Number of Positions

CONNECTOR	ACTUATOR VOLTAGE	NUMBER OF POSITIONS	ACTUATOR TYPE	OPTIONS
K: 2.92mm FEMALE	6: 28 VDC LATCHING	3: SP3T	0: NO INDICATOR CONTACTS	T: TTL DRIVERS WITH DIODES
	7: 15 VDC LATCHING	4: SP4T	C: INDICATOR CONTACTS***	D: COIL TRANSIENT SUPPRESSION DIODES
	8: 12 VDC LATCHING	5: SP5T	D: SELF CUTOFF ONLY	R: POSITIVE + COMMON
	9: 24 VDC LATCHING	6: SP6T		TD: DECODERS AND TTL DRIVERS WITH DIODES
				M: MOISTURE SEAL
				S: D-SUB CONNECTOR*

**SEE PARTS LIST ON PAGE 11-13
***Indicator Contacts Operating Temperature -50°C to 85°C (Elite Model Only)

For additional options, please contact factory.

* D-Sub Connector may be 9,15, 25 pin depending on number of throws. (See Connector Pinout page)

Series CCT-49K/CT-49K

Internal 50Ω Termination DC-40 GHz
Latching Multi-Throw Coaxial Switch



SCHEMATICS AND MECHANICAL OUTLINE

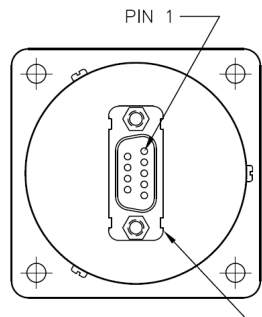
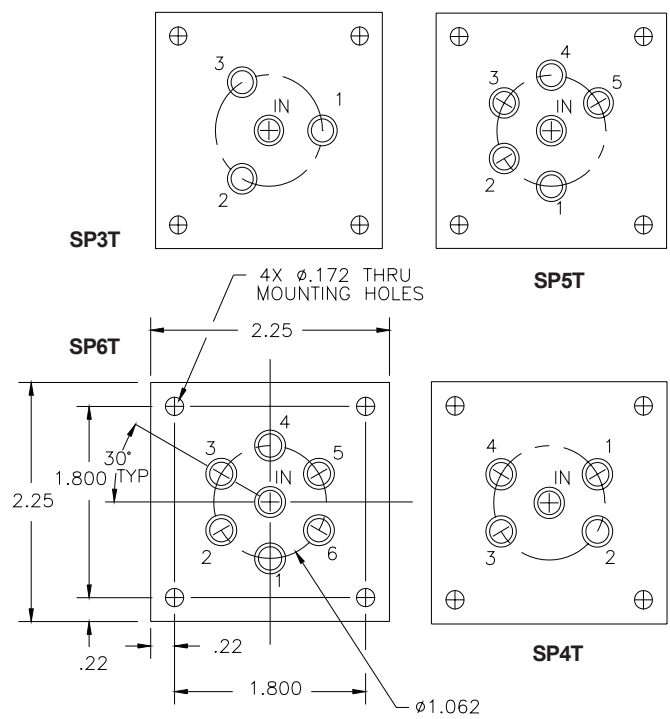
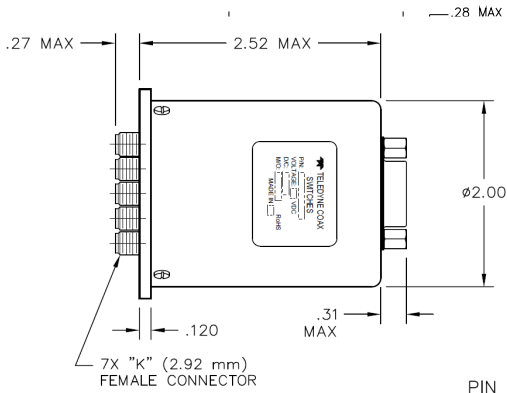
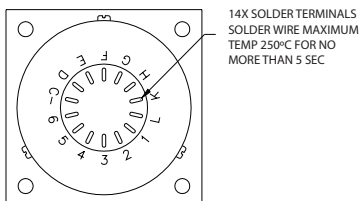
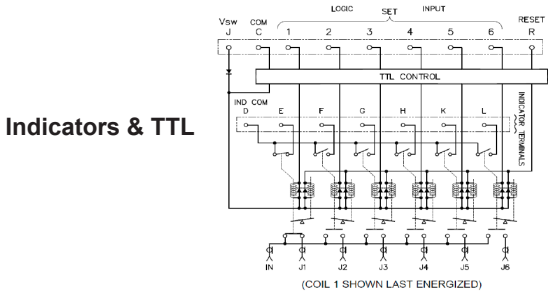
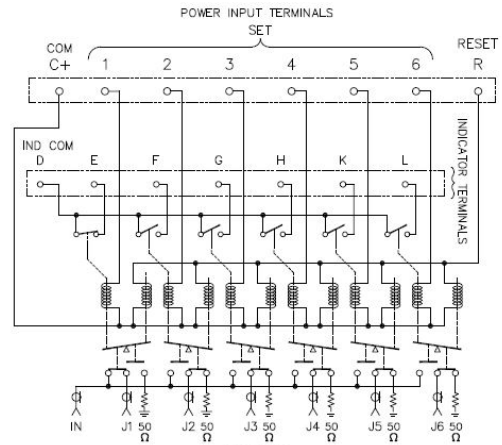
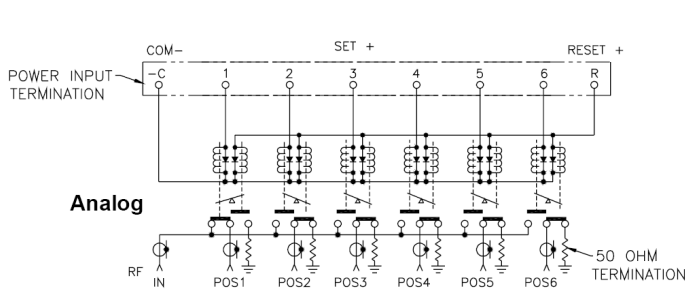

9-PIN D-SUB MINI CONNECTOR

MPL: CCT-49Ks660-S

CONNECTOR PINOUT FOR LATCHING SP3T MULTI-THROW SWITCHES						
EXAMPLE	CT-49K630-S	CT49K63C-S	CT49K630-TS	CT49K63C-TS	CT49K630-TDS	CT49K63C-TDS
INDICATOR		Yes		Yes		Yes
TTL			Yes	Yes		
DECODERS & TTL					Yes	Yes
PIN NO.	9-PIN	15-PIN	9-PIN	15-PIN	9-PIN	15-PIN
1	PORT 1	PORT 1	TTL 1	TTL 1	LOGIC 1	LOGIC 1
2	PORT 2	PORT 2	TTL 2	TTL 2	LOGIC 2	LOGIC 2
3	PORT 3	PORT 3	TTL 3	TTL 3	LOGIC 3	LOGIC 3
4						
5						
6						
7	COMMON	COMMON	COMMON	COMMON	COMMON	COMMON
8	RESET	RESET	RESET	RESET	RESET	RESET
9			VSW	VSW	VSW	VSW
10		D INDICATOR (COM)		D INDICATOR (COM)		D INDICATOR (COM)
11		E INDICATOR		E INDICATOR		E INDICATOR
12		F INDICATOR		F INDICATOR		F INDICATOR
13		G INDICATOR		G INDICATOR		G INDICATOR
14						
15						



9-PIN D-SUB CONNECTOR

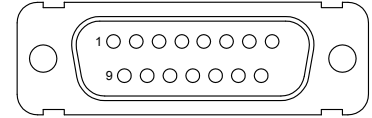

15-PIN D-SUB CONNECTOR

“-S option” 9-pin, 15-pin connector
(example: CCT-49KS660-S)

CONNECTOR PINOUT FOR LATCHING SP4T MULTI-THROW SWITCHES						
EXAMPLE	CT-49K640-S	CT49K64C-S	CT49K640-TS	CT49K64C-TS	CT49K640-TDS	CT49K64C-TDS
INDICATOR		Yes		Yes		Yes
TTL			Yes	Yes		
DECODERS & TTL					Yes	Yes
PIN NO.	9-PIN	15-PIN	9-PIN	15-PIN	9-PIN	15-PIN
1	PORT 1	PORT 1	TTL 1	TTL 1	LOGIC 1	LOGIC 1
2	PORT 2	PORT 2	TTL 2	TTL 2	LOGIC 2	LOGIC 2
3	PORT 3	PORT 3	TTL 3	TTL 3	LOGIC 3	LOGIC 3
4	PORT 4	PORT 4	TTL 4	TTL 4		
5						
6						
7	COMMON	COMMON	COMMON	COMMON	COMMON	COMMON
8	RESET	RESET	RESET	RESET	RESET	RESET
9			VSW	VSW	VSW	VSW
10		D INDICATOR (COM)		D INDICATOR (COM)		D INDICATOR (COM)
11		E INDICATOR		E INDICATOR		E INDICATOR
12		F INDICATOR		F INDICATOR		F INDICATOR
13		G INDICATOR		G INDICATOR		G INDICATOR
14		H INDICATOR		H INDICATOR		H INDICATOR
15						

CONNECTOR PINOUT FOR LATCHING SP5T MULTI-THROW SWITCHES						
EXAMPLE	CT-49K650-S	CT49K65C-S	CT49K650-TS	CT49K65C-TS	CT49K650-TDS	CT49K65C-TDS
INDICATOR		Yes		Yes		Yes
TTL			Yes	Yes		
DECODERS & TTL					Yes	Yes
PIN NO.	9-PIN	15-PIN	9-PIN	15-PIN	9-PIN	15-PIN
1	PORT 1	PORT 1	TTL 1	TTL 1	LOGIC 1	LOGIC 1
2	PORT 2	PORT 2	TTL 2	TTL 2	LOGIC 2	LOGIC 2
3	PORT 3	PORT 3	TTL 3	TTL 3	LOGIC 3	LOGIC 3
4	PORT 4	PORT 4	TTL 4	TTL 4		
5	PORT 5	PORT 5	TTL 5	TTL 5		
6						
7	COMMON	COMMON	COMMON	COMMON	COMMON	COMMON
8	RESET	RESET	RESET	RESET	RESET	RESET
9			VSW	VSW	VSW	VSW
10		D INDICATOR (COM)		D INDICATOR (COM)		D INDICATOR (COM)
11		E INDICATOR		E INDICATOR		E INDICATOR
12		F INDICATOR		F INDICATOR		F INDICATOR
13		G INDICATOR		G INDICATOR		G INDICATOR
14		H INDICATOR		H INDICATOR		H INDICATOR
15		K INDICATOR		K INDICATOR		K INDICATOR

Series CCT-49K/CT-49K
 Internal 50Ω Termination DC-40 GHz
 Latching Multi-Throw Coaxial Switch



CONNECTOR PINOUT FOR LATCHING SP6T MULTI-THROW SWITCHES						
EXAMPLE	CT-49K660-S	CT49K66C-S	CT49K660-TS	CT49K66C-TS	CT49K660-TDS	CT49K66C-TDS
INDICATOR		YES		YES		YES
TTL			YES	YES		YES
DECODERS & TTL					YES	YES
PIN NO.	9-PIN	15-PIN	9-PIN	15-PIN	9-PIN	15-PIN
1	PORT 1	PORT 1	TTL 1	TTL 1	LOGIC 1	LOGIC 1
2	PORT 2	PORT 2	TTL 2	TTL 2	LOGIC 2	LOGIC 2
3	PORT 3	PORT 3	TTL 3	TTL 3	LOGIC 3	LOGIC 3
4	PORT 4	PORT 4	TTL 4	TTL 4		
5	PORT 5	PORT 5	TTL 5	TTL 5		VSW
6	PORT 6	PORT 6	TTL 6	TTL 6		
7	COMMON	COMMON	COMMON	COMMON	COMMON	COMMON
8	RESET	RESET	RESET	RESET		
9		D INDICATOR (COM)	VSW	VSW	VSW	D INDICATOR (COM)
10		E INDICATOR				E INDICATOR
11		F INDICATOR				F INDICATOR
12		G INDICATOR				G INDICATOR
13		H INDICATOR				H INDICATOR
14		K INDICATOR				K INDICATOR
15		L INDICATOR				L INDICATOR
16				D INDICATOR (COM)		
17				E INDICATOR		
18				F INDICATOR		
19				G INDICATOR		
20				H INDICATOR		
21				K INDICATOR		
22				L INDICATOR		
23						
24						
25						

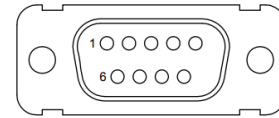

9-PIN D-SUB CONNECTOR

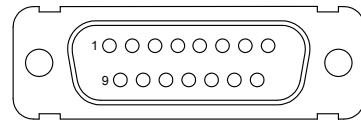

15-PIN D-SUB CONNECTOR

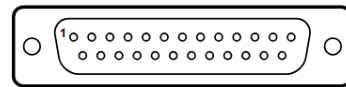

25-PIN D-SUB CONNECTOR

“-S option” 9-pin, 15-pin, 25-pin connector
 (example: [CCT-49KS660-S](#))

TRUTH TABLE Latching
CCT-49KX3C-T

Logic Input				RF Path				Indicator Switches		
1	2	3	R	J1	J2	J3	Reset	E	F	G
1	0	0	0	On	Off	Off	Off	C	0	0
0	1	0	0	Off	On	Off	Off	0	C	0
0	0	1	0	Off	Off	On	Off	0	0	C

TRUTH TABLE Latching
CCT-49KX3C-TD

Logic Input			RF Path				Indicator Switches		
1	2	3	J1	J2	J3	Reset	E	F	G
0	0	0	On	Off	Off	Off	C	0	0
1	0	0	Off	On	Off	Off	0	C	0
0	1	0	Off	Off	On	Off	0	0	C
0	1	1	Off	Off	Off	Reset	0	0	0
1	1	1	COIL OFF				0	0	0

TRUTH TABLE Latching
CCT-49KX4C-T

Logic Input					RF Path					Indicator Switches			
1	2	3	4	R	J1	J2	J3	J4	Reset	E	F	G	H
1	0	0	0	0	On	Off	Off	Off	Off	C	0	0	0
0	1	0	0	0	Off	On	Off	Off	Off	0	C	0	0
0	0	1	0	0	Off	Off	On	Off	Off	0	0	C	0
0	0	0	1	0	Off	Off	Off	On	Off	0	0	0	C

TRUTH TABLE Latching
CCT-49KX4C-TD

Logic Input			RF Path					Indicator Switches			
1	2	3	J1	J2	J3	J4	Reset	E	F	G	H
0	0	0	On	Off	Off	Off	Off	C	0	0	0
1	0	0	Off	On	Off	Off	Off	0	C	0	0
0	1	0	Off	Off	On	Off	Off	0	0	C	0
1	1	0	Off	Off	Off	On	Off	0	0	0	C
0	1	1	Off	Off	Off	Off	Reset	0	0	0	0
1	1	1	COIL OFF					0	0	0	0

Series CCT-49K/CT-49K

Internal 50Ω Termination DC-40 GHz
Latching Multi-Throw Coaxial Switch



TRUTH TABLE Latching CCT-49KX5C-T

Logic Input						RF Path						Indicator Switches				
1	2	3	4	5	R	J1	J2	J3	J4	J5	Reset	E	F	G	H	K
1	0	0	0	0	0	On	Off	Off	Off	Off	Off	C	0	0	0	0
0	1	0	0	0	0	Off	On	Off	Off	Off	Off	0	C	0	0	0
0	0	1	0	0	0	Off	Off	On	Off	Off	Off	0	0	C	0	0
0	0	0	1	0	0	Off	Off	Off	On	Off	Off	0	0	0	C	0
0	0	0	0	1	0	Off	Off	Off	Off	On	Off	0	0	0	0	C

TRUTH TABLE Latching CCT-49KX5C-TD

Logic Input			RF Path					Indicator Switches					
1	2	3	J1	J2	J3	J4	J5	Reset	E	F	G	H	K
0	0	0	On	Off	Off	Off	Off	Off	C	0	0	0	0
1	0	0	Off	On	Off	Off	Off	Off	0	C	0	0	0
0	1	0	Off	Off	On	Off	Off	Off	0	0	C	0	0
1	1	0	Off	Off	Off	On	Off	Off	0	0	0	C	0
0	0	1	Off	Off	Off	Off	On	Off	0	0	0	0	C
0	1	1	Off	Off	Off	Off	Off	Reset	0	0	0	0	0
1	1	1	COIL OFF					0	0	0	0	0	

TRUTH TABLE Latching CCT-49KX6C-T

Logic Input							RF Path						Indicator Switches						
1	2	3	4	5	6	R	J1	J2	J3	J4	J5	J6	Reset	E	F	G	H	K	L
1	0	0	0	0	0	0	On	Off	Off	Off	Off	Off	Off	C	0	0	0	0	0
0	1	0	0	0	0	0	Off	On	Off	Off	Off	Off	Off	0	C	0	0	0	0
0	0	1	0	0	0	0	Off	Off	On	Off	Off	Off	Off	0	0	C	0	0	0
0	0	0	1	0	0	0	Off	Off	Off	On	Off	Off	Off	0	0	0	C	0	0
0	0	0	0	1	0	0	Off	Off	Off	Off	On	Off	Off	0	0	0	0	C	0
0	0	0	0	0	1	0	Off	Off	Off	Off	Off	On	Off	0	0	0	0	0	C

TRUTH TABLE Latching CCT-49KX6C-TD

Logic Input			RF Path						Indicator Switches						
1	2	3	J1	J2	J3	J4	J5	J6	Reset	E	F	G	H	K	L
0	0	0	On	Off	Off	Off	Off	Off	Off	C	0	0	0	0	0
1	0	0	Off	On	Off	Off	Off	Off	Off	0	C	0	0	0	0
0	1	0	Off	Off	On	Off	Off	Off	Off	0	0	C	0	0	0
1	1	0	Off	Off	Off	On	Off	Off	Off	0	0	0	C	0	0
0	0	1	Off	Off	Off	Off	On	Off	Off	0	0	0	0	C	0
1	0	1	Off	Off	Off	Off	Off	On	Off	0	0	0	0	0	C
0	1	1	Off	Off	Off	Off	Off	Off	Reset	0	0	0	0	0	0
1	1	1	COIL OFF						0	0	0	0	0	0	

TYPICAL RF PERFORMANCE CURVES

INSERTION LOSS

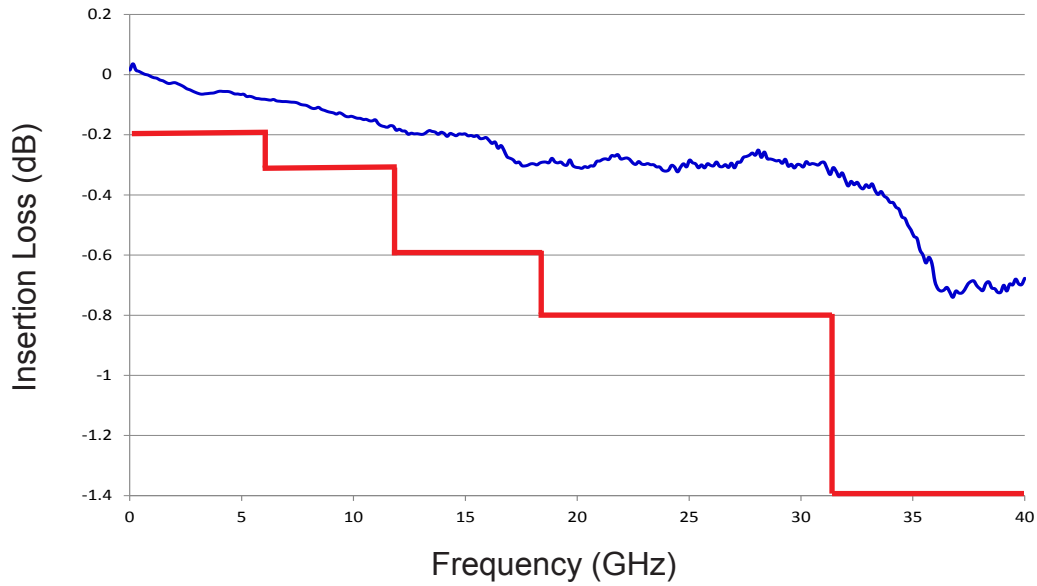

VSWR

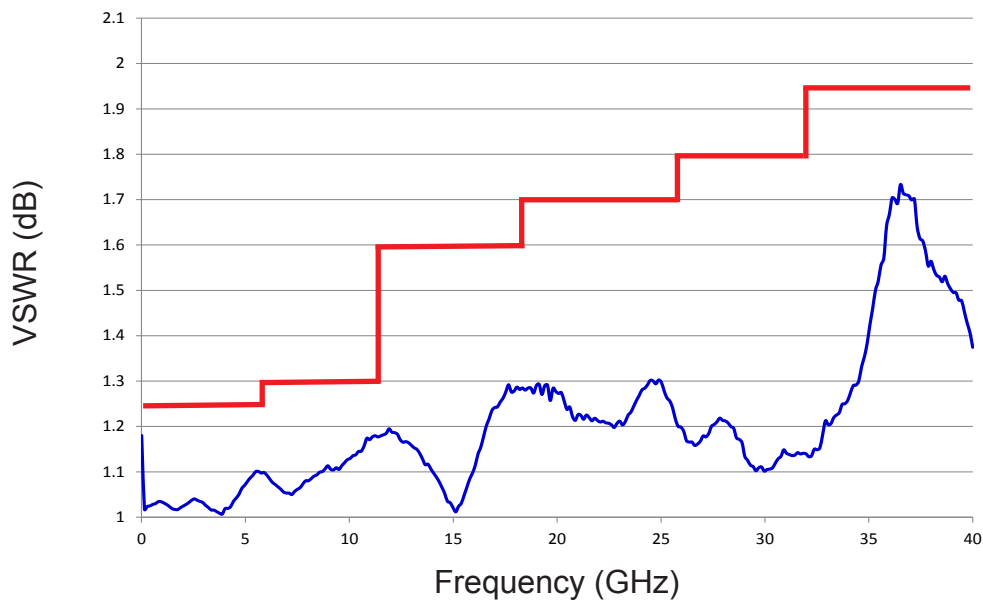

TYPICAL RF PERFORMANCE CURVES

ISOLATION



TYPICAL POWER PERFORMANCE CURVE

Power Handling vs. Frequency

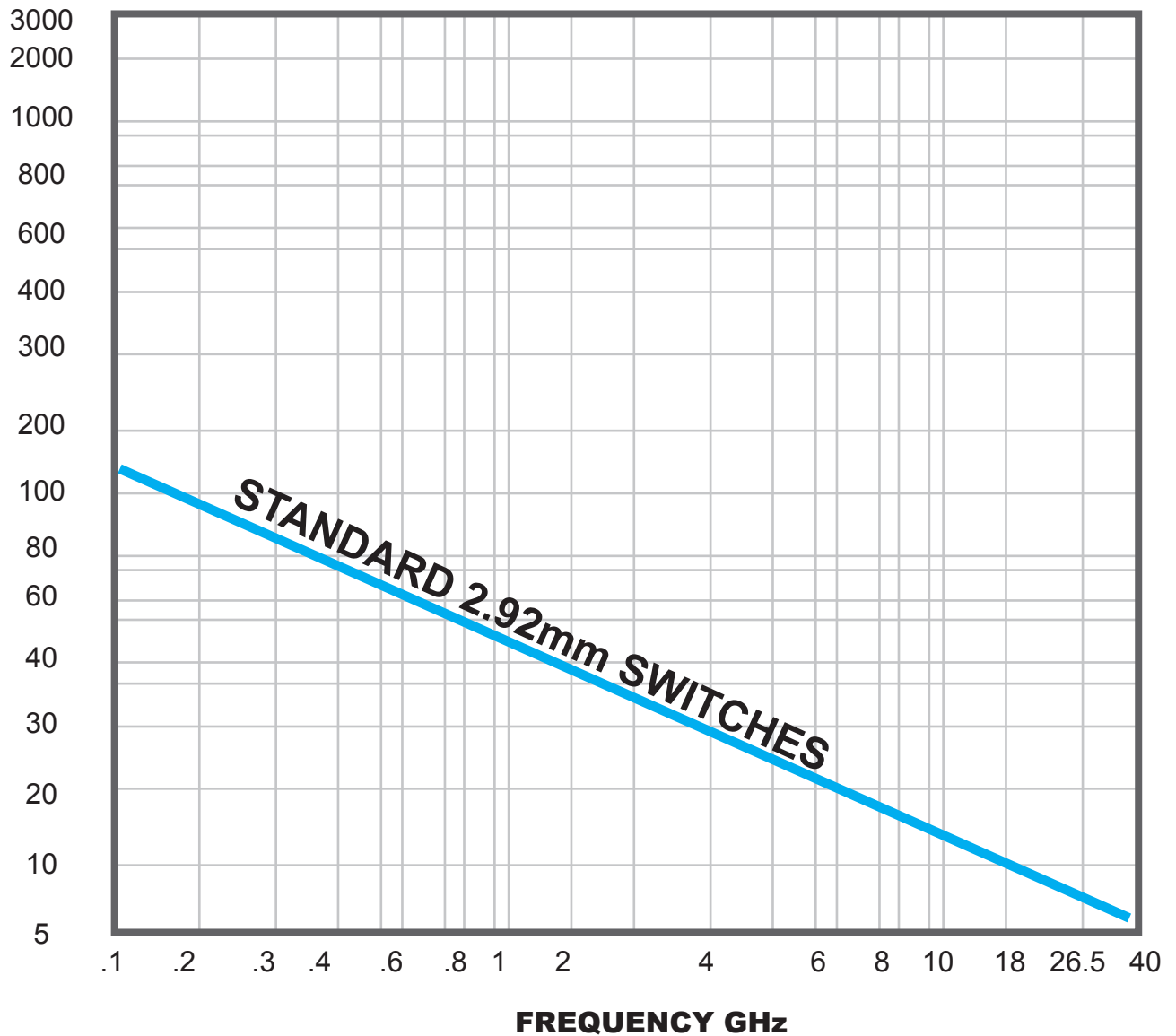

Estimates based on the following reference conditions:

- Ambient temperature of 40°C or less
- Sea level operation
- Load VSWR of 1.20:1 maximum
- No high-power (hot) switching

Please contact Teledyne Coax Switches for derating factors when applications do not meet the foregoing reference conditions.