

CDBA320L-G Thru. CDBA340L-G

Reverse Voltage: 20 to 40 Volts

Forward Current: 3.0 Amp

RoHS Device

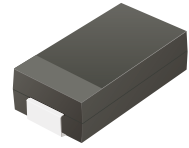

Features

- Ideal for surface mount applications.
- Easy pick and place.
- Plastic package has Underwriters Lab. flammability classification 94V-0.
- Built in strain relief.
- Super low forward voltage drop.

Mechanical data

- Case: JEDEC DO-214AC, molded plastic.
- Terminals: solderable per MIL-STD-750, method 2026.
- Polarity: Color band denotes cathode end.
- Approx. weight: 0.064 grams(approx.).

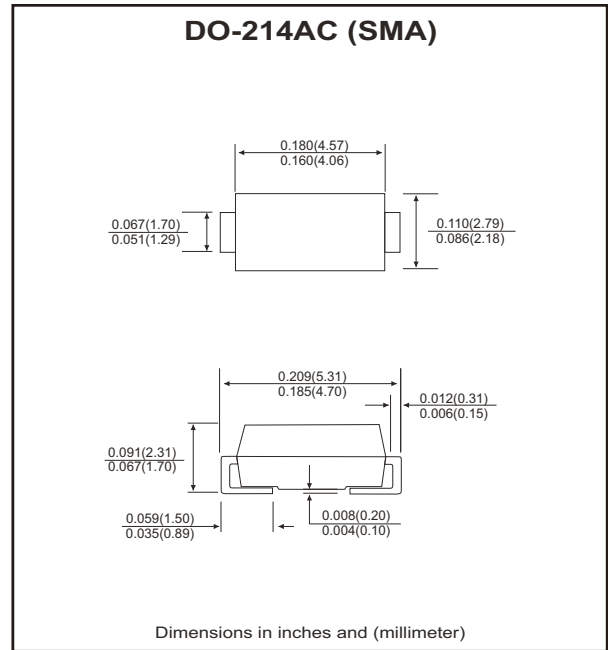

Maximum Ratings and Electrical Characteristics

Single phase half wave, 60Hz, resistive or inductive load. For Capacitive load, derate current by 20%.

Parameter	Symbol	CDBA320L-G	CDBA340L-G	Units
Max. repetitive peak reverse voltage	V_{RRM}	20	40	V
Max. DC blocking voltage	V_{DC}	20	40	V
Max. RMS voltage	V_{RMS}	14	28	V
Peak surge forward current, 8.3ms single half sine-wave superimposed on rate load (JEDEC method)	I_{FSM}	80		A
Max. average forward current	I_o	3.0		A
Max. instantaneous forward voltage at 3.0A	V_F	0.38	0.40	V
Max. DC reverse current at rated DC blocking voltage	I_R	1.5 @ $T_A=25^{\circ}C$ 60 @ $T_A=80^{\circ}C$		mA
Max. thermal resistance (Note 1)	$R_{\theta JA}$ $R_{\theta JL}$	88 20		$^{\circ}C/W$
Max. operating junction temperature	T_J	125		$^{\circ}C$
Storage temperature	T_{STG}	-50 to +150		$^{\circ}C$

Notes: 1. Thermal resistance from junction to ambient and junction to lead, P.C.B. mounted on 0.2x0.2 inch copper pad area.

RATING AND CHARACTERISTIC CURVES (CDBA320L-G thru CDBA340L-G)

Fig.1 Reverse Characteristics

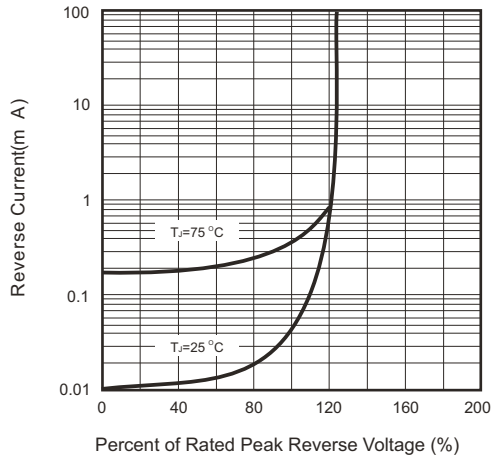

Fig.2 Forward Characteristics

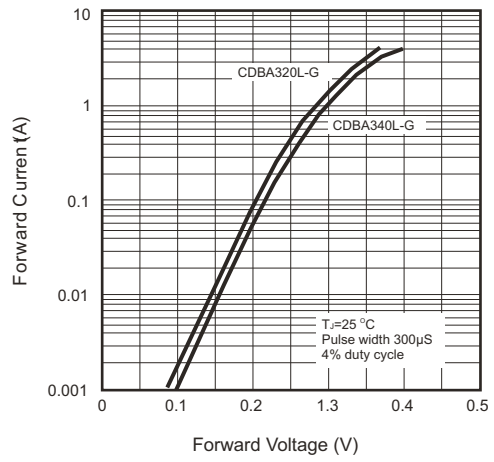

Fig.3 Junction Capacitance

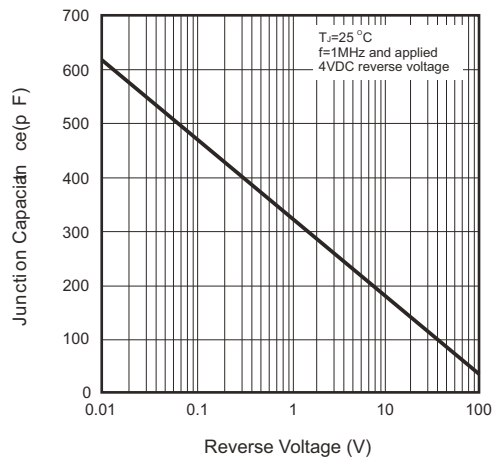

Fig.4 Current Derating Curve

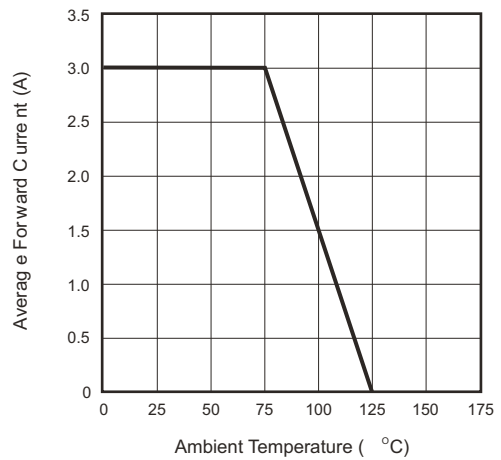
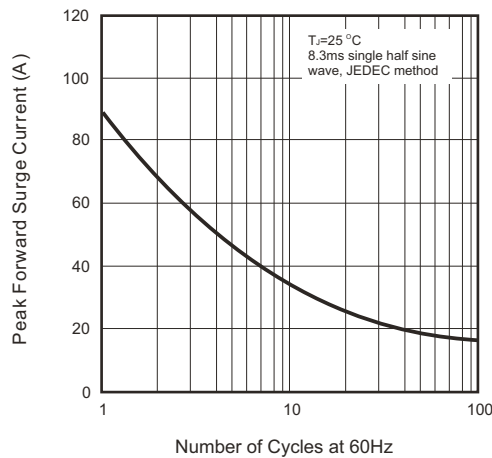

Fig.5 Non-repetitive Forward Surge Current



Company reserves the right to improve product design , functions and reliability without notice.

REV:A

Reel Taping Specification

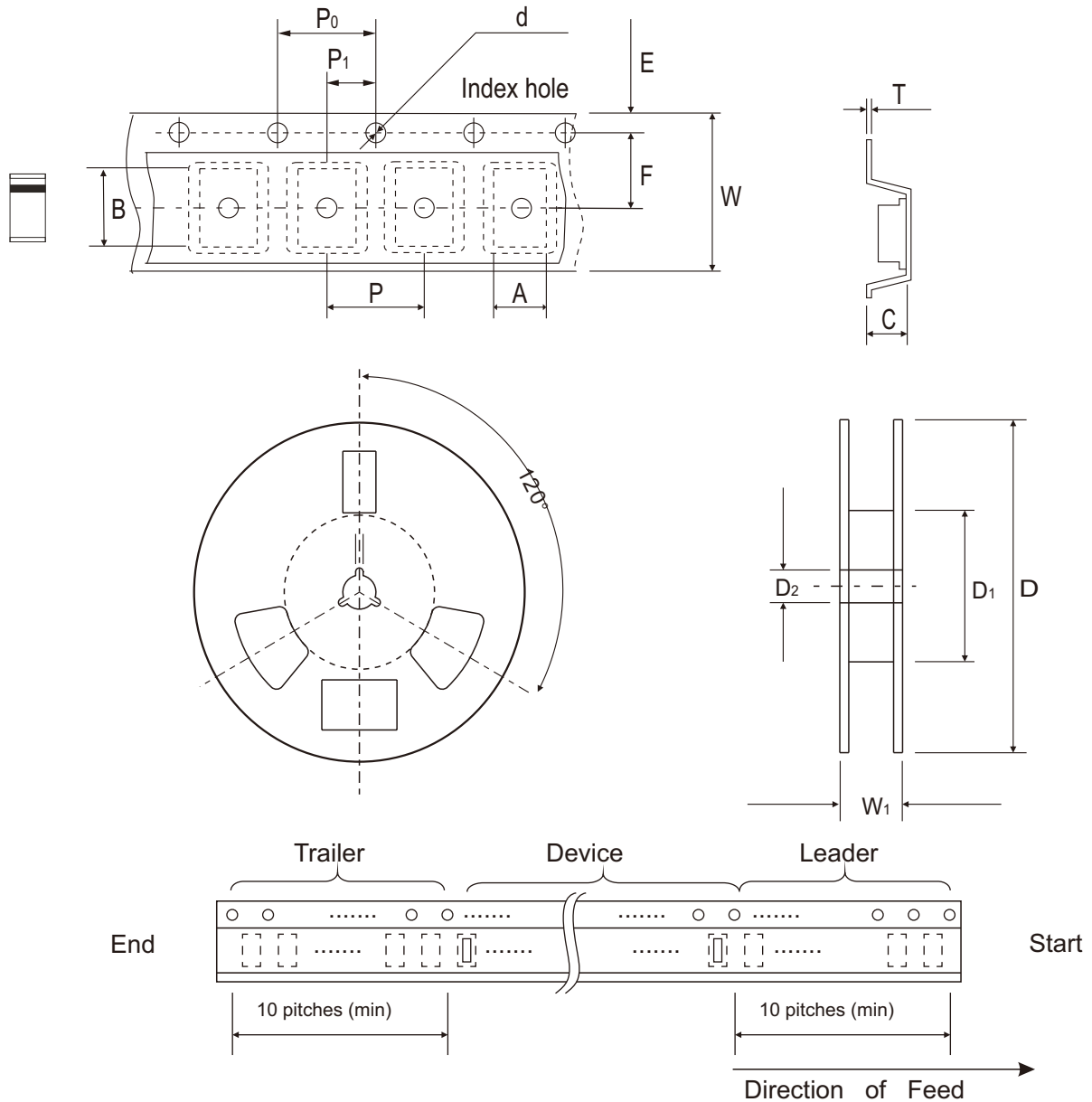

DO-214AC (SMA)	SYMBOL	A	B	C	d	D	D ₁	D ₂
	(mm)	2.8 ± 0.10	5.00 ± 0.10	1.90 ± 0.10	1.50 ± 0.10	178 ± 2.00	62.0 MIN.	13.0 ± 0.50
	(inch)	0.110 ± 0.004	0.197 ± 0.004	0.075 ± 0.004	0.059 ± 0.004	7.008 ± 0.078	2.441 MIN.	0.512 ± 0.008

DO-214AC (SMA)	SYMBOL	E	F	P	P ₀	P ₁	W	W ₁
	(mm)	1.75 ± 0.10	5.50 ± 0.10	4.00 ± 0.10	4.00 ± 0.10	2.00 ± 0.10	12.00 ± 0.30	18.00 ± 1.00
	(inch)	0.069 ± 0.004	0.217 ± 0.002	0.157 ± 0.004	0.157 ± 0.004	0.079 ± 0.004	0.472 ± 0.012	0.709 ± 0.040