

CDBA5819-HF

Reverse Voltage: 40 Volts

Forward Current: 1A

RoHS Device

Halogen Free

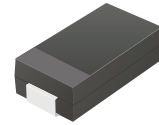

Features

- Ideal for surface mount applications.
- Easy pick and place.
- Plastic package has Underwriters Lab. flammability classification 94V-0.
- Built-in strain relief.
- Low forward voltage drop.

Mechanical data

- Case: JEDEC DO-214AC, molded plastic.
- Terminals: Solderable per MIL-STD-750, method 2026.
- Polarity: Color band denotes cathode end.
- Weight: 0.064 grams(Approx.).

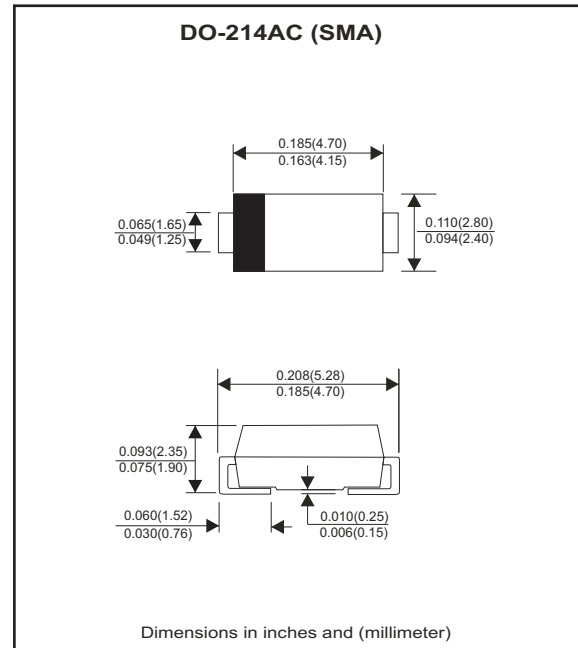

Circuit diagram



Maximum Ratings (at TA=25°C unless otherwise noted)

Parameter	Symbol	Value	Unit
Maximum repetitive peak reverse voltage	V _{RRM}	40	V
Maximum DC bolcking voltage	V _{DC}	40	V
Maximum RMS voltage	V _{RMS}	28	V
Peak surge forward current 8.3ms single half sine-wave superimposed on rate load (JEDEC method)	I _{FSM}	20	A
Maximum Average forward current	I _O	1	A
Thermal resistance from junction to ambience	R _{ΘJA}	55	°C/W
Operating junction temperature range	T _j	-55 to +125	°C
Storage temperature range	T _{STG}	-55 to +125	°C

Electrical Characteristics (at TA=25°C unless otherwise noted)

Parameter	Symbol	Value	Unit
Max. Forward voltage at 1.0 A (Note 1)	V _F	0.55	V
Max. DC reverse current at rated DC blocking voltage	I _R	0.5 20	mA
		T _a = 25°C	
		T _a = 100°C	

Note 1: Pulse test:300µs pulse width, 1% duty cycle.

RATING AND CHARACTERISTIC CURVES (CDBA5819-HF)

Fig.1 - Typical Forward Characteristics

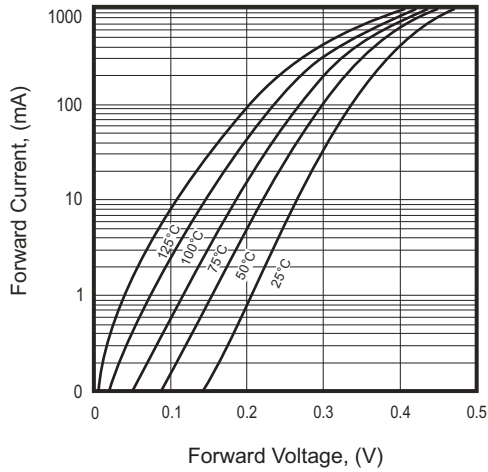

Fig.2 - Typical Reverse characteristics

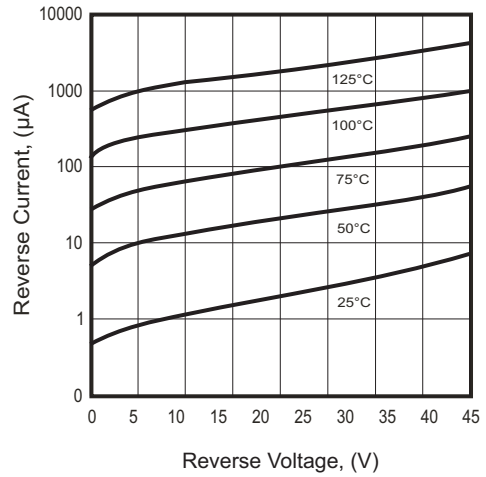

Fig.3 - Current Derating Curve

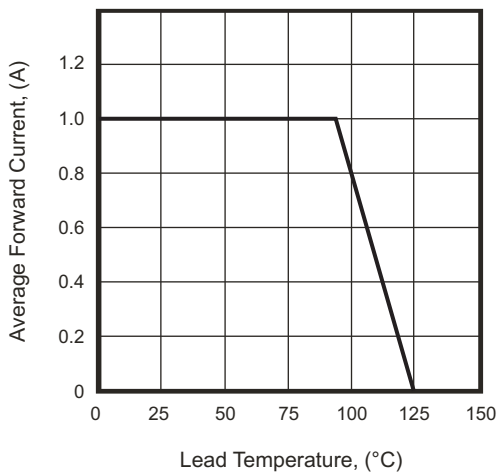
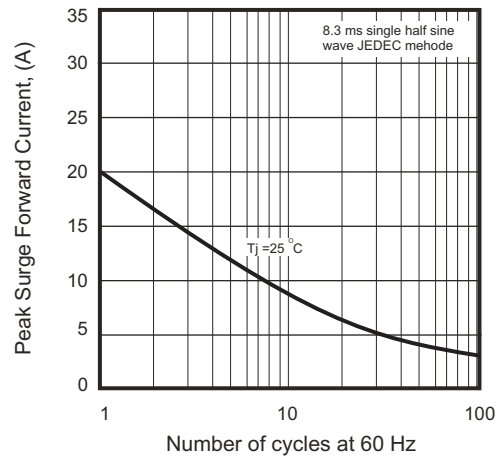
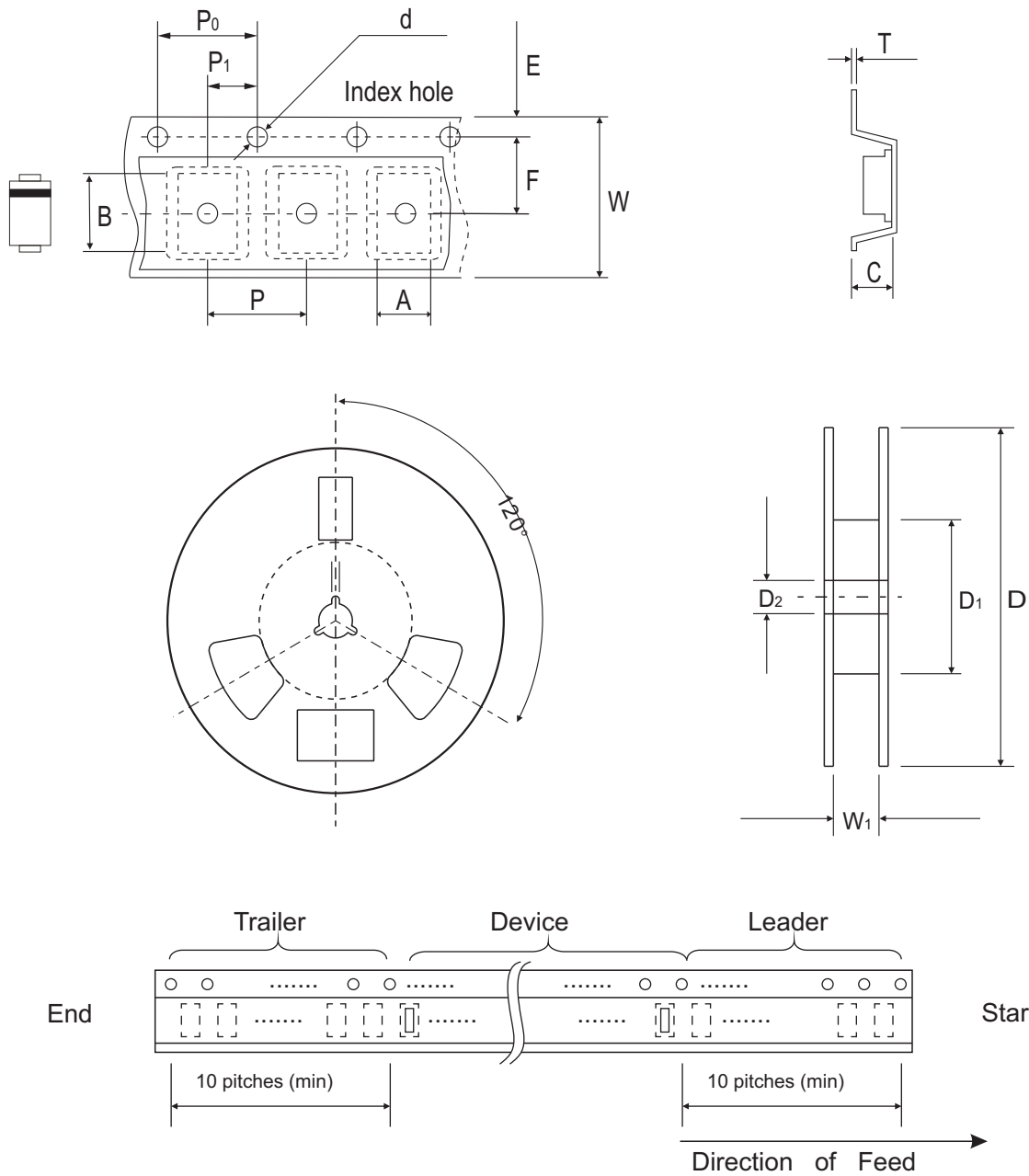

Fig.4 - Non Repetitive Peak Forward Surge Current



Reel Taping Specification



SMA (DO-214AC)	SYMBOL	A	B	C	d	D	D1	D2
	(mm)	2.60 ± 0.15	5.18 ± 0.17	2.36 ± 0.10	1.50 ± 0.10	330 ± 1.50	75.00 ± 1.00	13.50 ± 0.50
	(inch)	0.102 ± 0.006	0.204 ± 0.007	0.093 ± 0.004	0.059 ± 0.004	12.992 ± 0.060	2.953 ± 0.040	0.531 ± 0.020

SMA (DO-214AC)	SYMBOL	E	F	P	P0	P1	W	W1
	(mm)	1.75 ± 0.10	5.50 ± 0.05	4.00 ± 0.10	4.00 ± 0.10	2.00 ± 0.05	12.00 ± 0.200	13.50 ± 0.50
	(inch)	0.069 ± 0.004	0.217 ± 0.002	0.157 ± 0.004	0.157 ± 0.004	0.079 ± 0.002	0.472 ± 0.008	0.531 ± 0.020