

# SMD Schottky Barrier Diode

## CDBF0230L-HF

$I_o = 200 \text{ mA}$   
 $V_R = 30 \text{ Volts}$   
 RoHS Device  
 Halogen Free

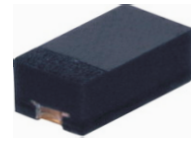

### Features

- Low forward voltage.
- Designed for mounting on small surface.
- Extremely thin / leadless package.
- Majority carrier conduction.

### Mechanical data

- Case: 1005/SOD-323F standard package, molded plastic.
- Terminals: Gold plated, solderable per MIL-STD-750, method 2026.
- Marking code: cathode band & BA
- Mounting position: Any
- Weight: 0.006 gram(approx.).

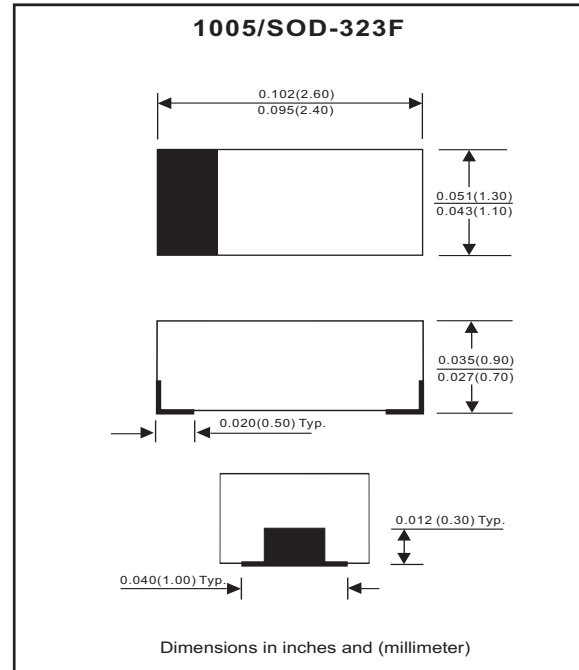

### Maximum Rating (at $T_A=25^\circ\text{C}$ unless otherwise noted)

Parameter	Conditions	Symbol	Min	Typ	Max	Unit
Repetitive peak reverse voltage		$V_{RRM}$			35	V
Reverse voltage		$V_R$			30	V
Average forward current		$I_o$			200	mA
Forward current,surge peak	8.3ms single half sine-wave superimposed on rate load(JEDEC method)	$I_{FSM}$			1	A
Storage temperature		$T_{STG}$	-40		+125	$^\circ\text{C}$
Junction temperature		$T_j$			+125	$^\circ\text{C}$

### Electrical Characteristics (at $T_A=25^\circ\text{C}$ unless otherwise noted)

Parameter	Conditions	Symbol	Min	Typ	Max	Unit
Forward voltage	$I_F = 200 \text{ mA}$	$V_F$			0.5	V
Reverse current	$V_R = 10 \text{ V}$	$I_R$			30	$\mu\text{A}$

## RATING AND CHARACTERISTIC CURVES (CDBF0230L-HF)

Fig. 1 - Forward characteristics

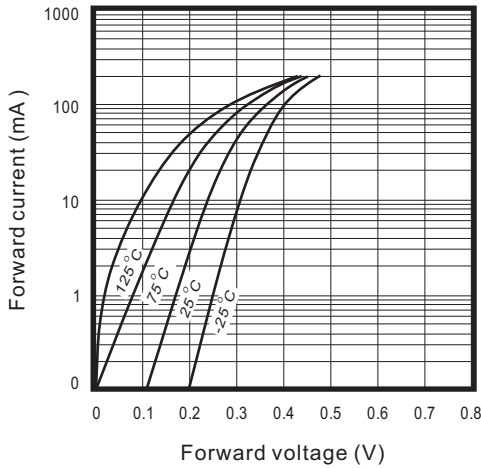

Fig. 2 - Reverse characteristics

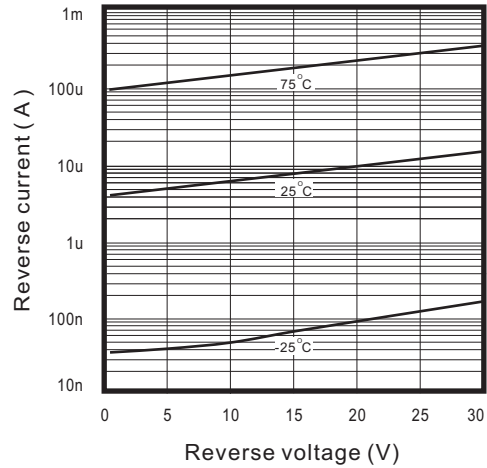

Fig.3 - Capacitance between terminals characteristics

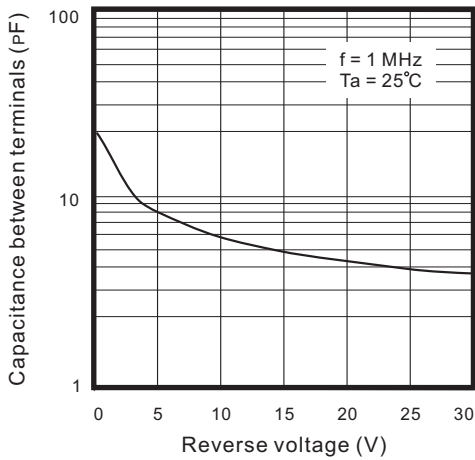

Fig.4 - Current derating curve

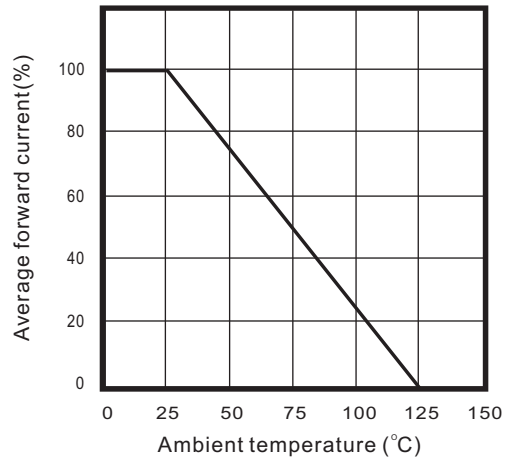

Fig. 5 - VF Dispersion map

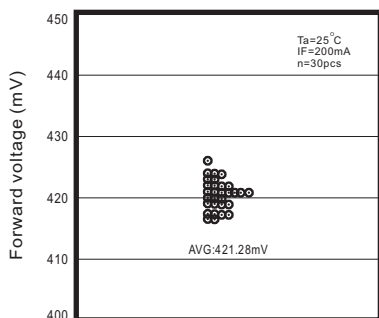

Fig. 6 - IR Dispersion map

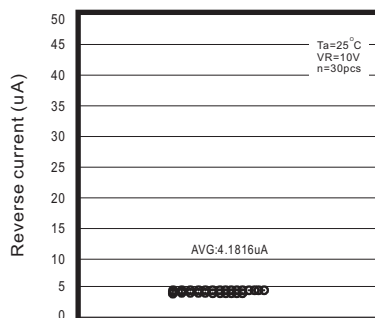
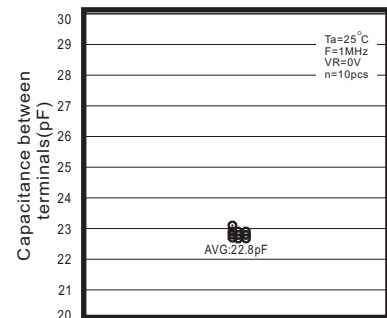
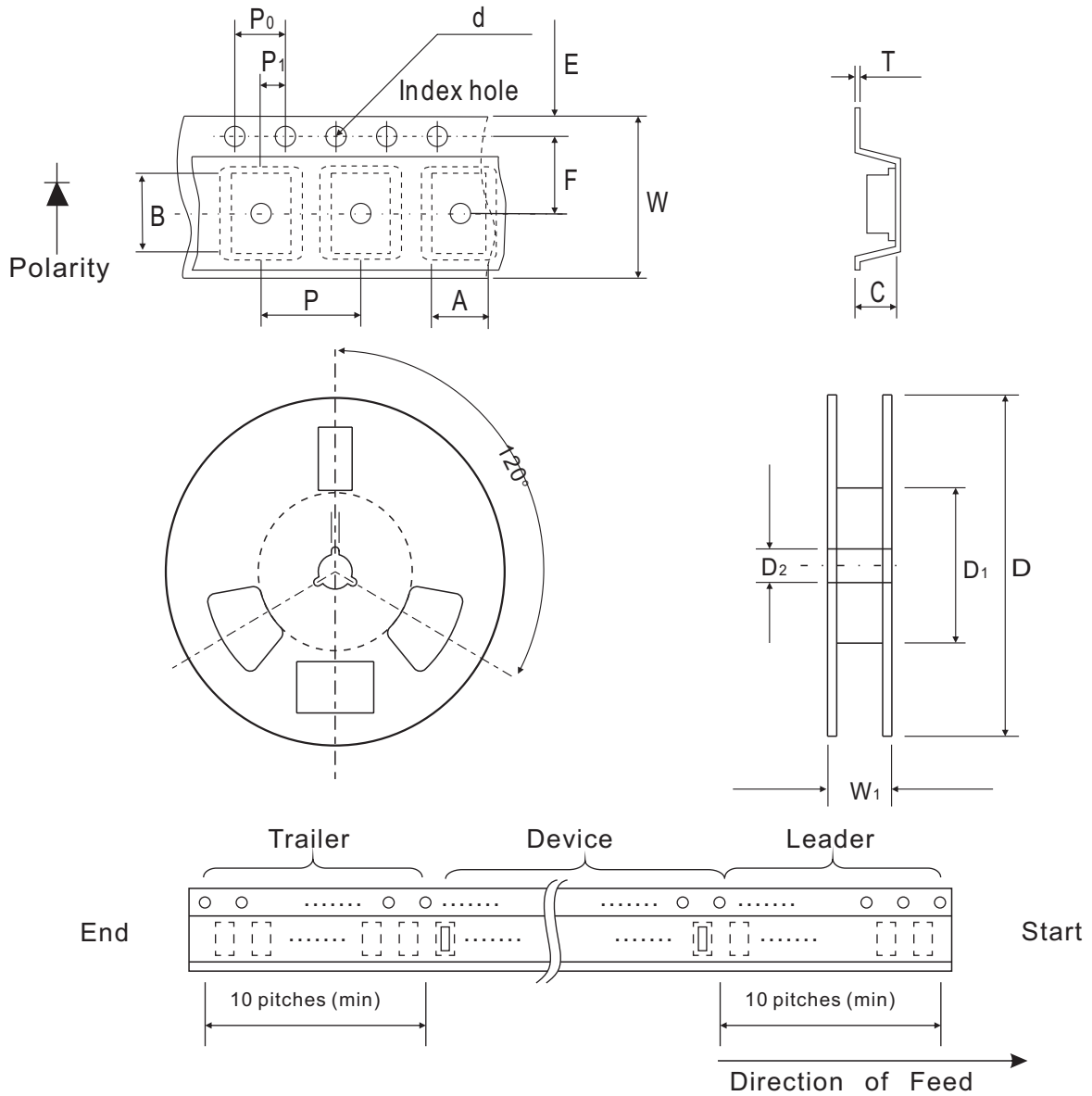

Fig. 7 - CT Dispersion map



## Reel Taping Specification



1005 (SOD-323F)	SYMBOL	A	B	C	d	D	D <sub>1</sub>	D <sub>2</sub>
	(mm)	1.55 ± 0.10	2.65 ± 0.10	1.05 ± 0.10	1.55 ± 0.05	178 ± 1	60.0 MIN.	13.0 ± 0.20
	(inch)	0.061 ± 0.004	0.104 ± 0.004	0.041 ± 0.004	0.061 ± 0.002	7.008 ± 0.04	2.362 MIN.	0.512 ± 0.008

1005 (SOD-323F)	SYMBOL	E	F	P	P <sub>0</sub>	P <sub>1</sub>	T	W	W <sub>1</sub>
	(mm)	1.75 ± 0.10	3.50 ± 0.05	4.00 ± 0.10	4.00 ± 0.10	2.00 ± 0.05	0.23 ± 0.05	8.00 ± 0.20	13.5 MAX.
	(inch)	0.069 ± 0.004	0.138 ± 0.002	0.157 ± 0.004	0.157 ± 0.004	0.079 ± 0.004	0.009 ± 0.002	0.315 ± 0.008	0.531 MAX.