

SMD Schottky Barrier Diode

CDBF54-HF

$I_o = 200 \text{ mA}$
 $V_R = 30 \text{ Volts}$
 RoHS Device
 Halogen Free

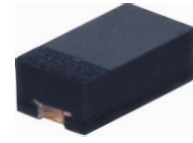

Features

- Low forward Voltage.
- Designed for mounting on small surface.
- Extremely thin / leadless package.
- Majority carrier conduction.

Mechanical data

- Case: 1005/SOD-323F standard package, molded plastic.
- Terminals: Gold plated, solderable per MIL-STD-750, method 2026.
- Marking code: cathode band & BF
- Mounting position: Any
- Weight: 0.006 gram(approx.).

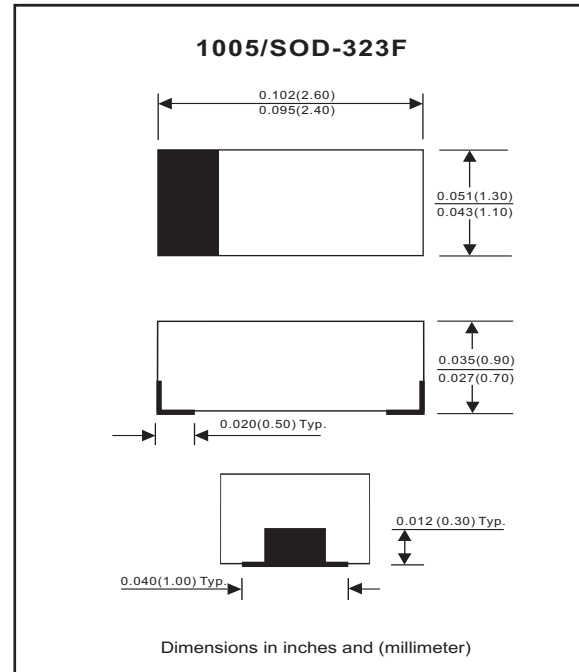

Maximum Rating (at $T_A=25^\circ\text{C}$ unless otherwise noted)

| Parameter | Conditions | Symbol | Min | Typ | Max | Unit |
|-----------------------------------|---|--------------|-----|-----|------|------------------|
| Peak reverse voltage | | V_{RM} | | | 30 | V |
| Reverse voltage | | V_R | | | 30 | V |
| RMS reverse voltage | | $V_{R(RMS)}$ | | | 21 | V |
| Average forward rectified current | | I_o | | | 200 | mA |
| Repetitive peak forward current | | I_{FRM} | | | 0.3 | A |
| Forward current, surge peak | 8.3 ms single half sine-wave superimposed on rate load (JEDEC method) | I_{FSM} | | | 0.6 | A |
| Power dissipation | | P_D | | | 200 | mW |
| Storage temperature | | T_{STG} | -65 | | +125 | $^\circ\text{C}$ |
| Junction temperature | | T_j | | | +125 | $^\circ\text{C}$ |

Electrical Characteristics (at $T_A=25^\circ\text{C}$ unless otherwise noted)

| Parameter | Conditions | Symbol | Min | Typ | Max | Unit |
|-------------------------------|--|----------|-----|-----|---------------------------------|---------------|
| Forward voltage | $I_F = 0.1\text{mA}$ $I_F = 1\text{mA}$ $I_F = 10\text{mA}$ $I_F = 30\text{mA}$ $I_F = 100\text{mA}$ | V_F | | | 0.24 0.32 0.4 0.5 1 | V |
| Reverse current | $V_R = 25\text{V}$ | I_R | | | 2 | μA |
| Capacitance between terminals | $f = 1 \text{ MHz}$, and 1 VDC reverse voltage | C_T | | | 10 | pF |
| Reverse recovery time | $I_F=I_R=10\text{mA}$, $I_{rr}=0.1 \times I_R$, $R_L=100 \text{ Ohm}$ | T_{rr} | | | 5 | nS |

RATING AND CHARACTERISTIC CURVES (CDBF54-HF)

Fig. 1 - Forward characteristics

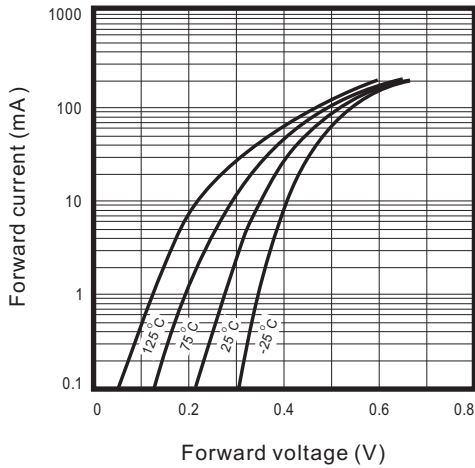

Fig. 2 - Reverse characteristics

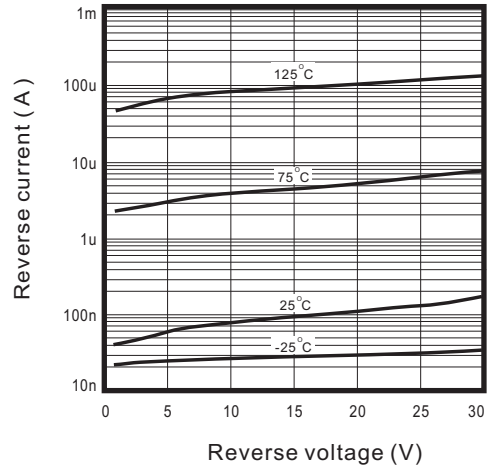

Fig.3 - Capacitance between terminals characteristics

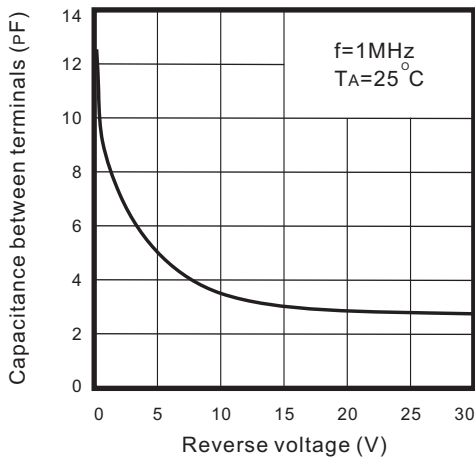
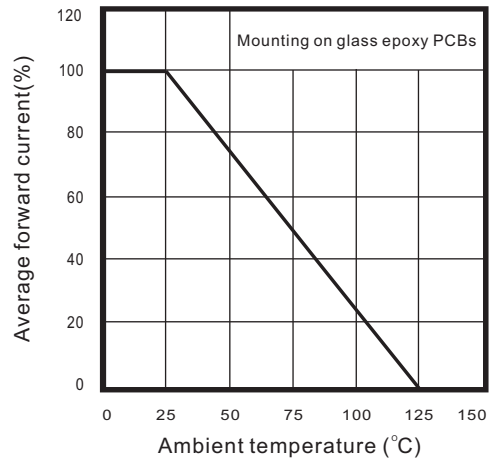
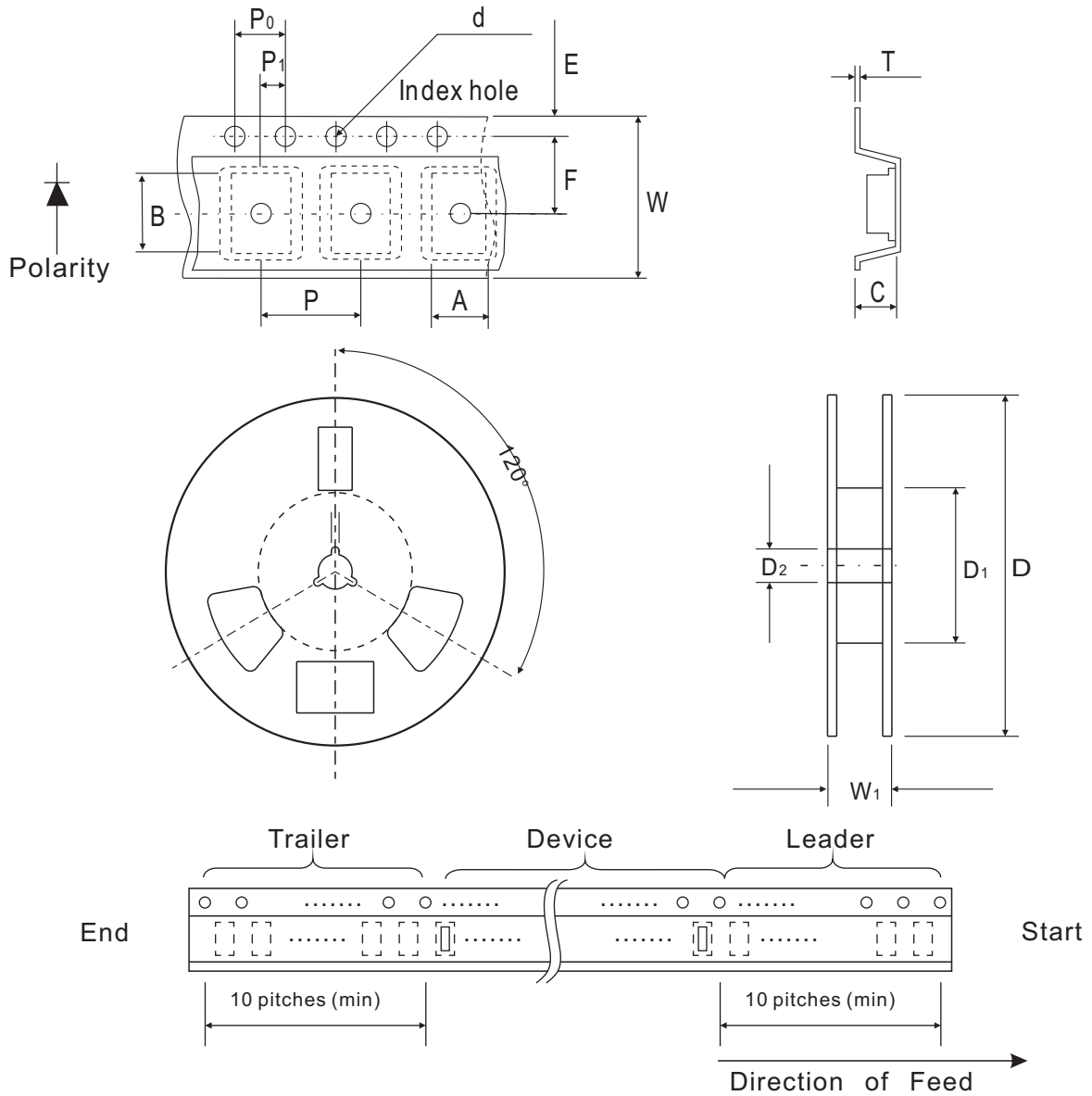

Fig.4 - Current derating curve



Reel Taping Specification



| 1005 (SOD-323F) | SYMBOL | A | B | C | d | D | D ₁ | D ₂ |
|--------------------|--------|---------------|---------------|---------------|---------------|--------------|----------------|----------------|
| | (mm) | 1.55 ± 0.10 | 2.65 ± 0.10 | 1.05 ± 0.10 | 1.55 ± 0.05 | 178 ± 1 | 60.0 MIN. | 13.0 ± 0.20 |
| | (inch) | 0.061 ± 0.004 | 0.104 ± 0.004 | 0.041 ± 0.004 | 0.061 ± 0.002 | 7.008 ± 0.04 | 2.362 MIN. | 0.512 ± 0.008 |

| 1005 (SOD-323F) | SYMBOL | E | F | P | P ₀ | P ₁ | T | W | W ₁ |
|--------------------|--------|---------------|---------------|---------------|----------------|----------------|---------------|---------------|----------------|
| | (mm) | 1.75 ± 0.10 | 3.50 ± 0.05 | 4.00 ± 0.10 | 4.00 ± 0.10 | 2.00 ± 0.05 | 0.23 ± 0.05 | 8.00 ± 0.20 | 13.5 MAX. |
| | (inch) | 0.069 ± 0.004 | 0.138 ± 0.002 | 0.157 ± 0.004 | 0.157 ± 0.004 | 0.079 ± 0.004 | 0.009 ± 0.002 | 0.315 ± 0.008 | 0.531 MAX. |