

## CDBFR0320/0330/0340-HF

$I_o = 350 \text{ mA}$

$V_R = 20 \text{ to } 40 \text{ Volts}$

RoHS Device

Halogen Free

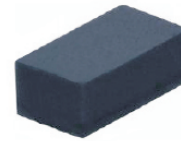

### Features

- Low forward voltage.
- Designed for mounting on small surface.
- Extremely thin / leadless package.
- Majority carrier conduction.

### Mechanical data

- Case: 1005/SOD-323F standard package, molded plastic.
- Terminals: Gold plated, solderable per MIL-STD-750, method 2026
- Polarity: Indicated by cathode band.
- Mounting position: Any
- Weight: 0.006 grams (approx.).

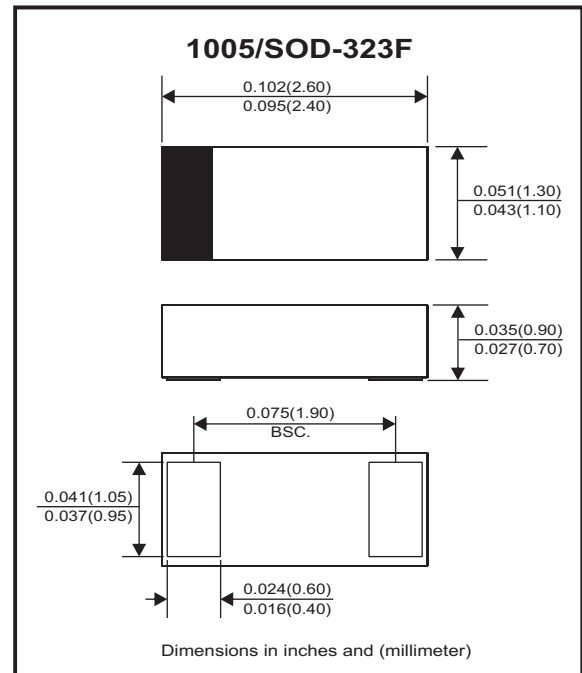

### Circuit Diagram



### Maximum Rating (at $T_A=25^\circ\text{C}$ unless otherwise noted)

Parameter	Symbol	CDBFR0320-HF	CDBFR0330-HF	CDBFR0340-HF	Unit
Repetitive Peak reverse voltage	$V_{RRM}$	20	30	40	V
Reverse voltage	$V_R$	20	30	40	V
RMS reverse voltage	$V_{R(MS)}$	14	21	28	V
Average forward rectified current	$I_o$	350			mA
Peak forward surge current 8.3 ms single half sine-wave	$I_{FSM}$	1.5			A
Power dissipation	$P_D$	200			mA
Thermal resistance junction to ambient air	$R_{\theta JA}$	500			$^\circ\text{C/W}$
Junction temperature	$T_j$	+125			$^\circ\text{C}$
Storage temperature range	$T_{STG}$	-65 to +125			$^\circ\text{C}$

### Electrical Characteristics (at $T_A=25^\circ\text{C}$ unless otherwise noted)

Parameter	Conditions	Symbol	Min	Typ	Max	Unit
Reverse current	$V_R = 10\text{V}$ $V_R = 20\text{V}$ $V_R = 30\text{V}$	$I_R$			5 5 5	$\mu\text{A}$
Forward voltage	$I_F = 20\text{mA}$ $I_F = 200\text{mA}$	$V_F$			0.37 0.60	V
Capacitance between terminals	$f = 1 \text{ MHz}$ , and 0V DC reverse voltage	$C_T$		50		pF
Reverse recovery time	$I_F = I_R$ , $I_{rr} = 0.1X I_R$ , $R_L = 100 \text{ ohm}$	$T_{rr}$		6.4		nS

## RATING AND CHARACTERISTIC CURVES (CDBFR0320/0330/0340-HF)

Fig. 1 - Forward Characteristics

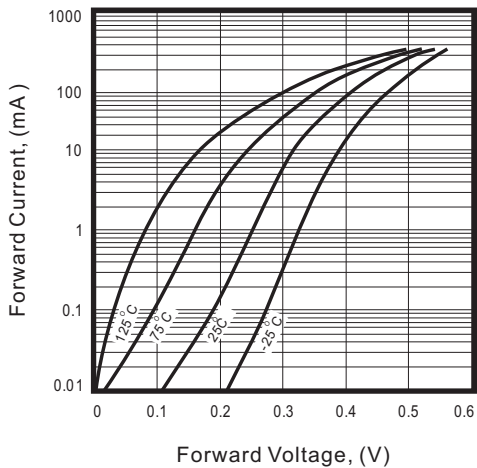

Fig. 2 - Reverse Characteristics

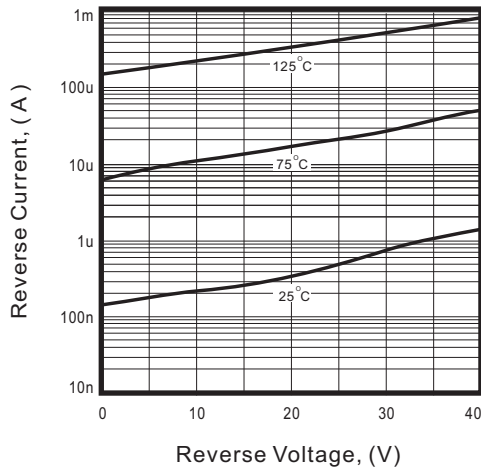

Fig.3 - Capacitance Between Terminals Characteristics

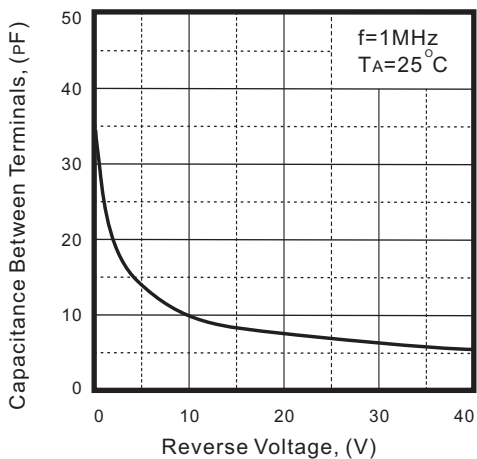
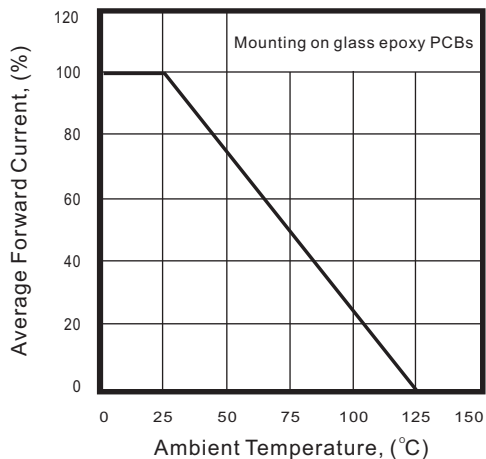
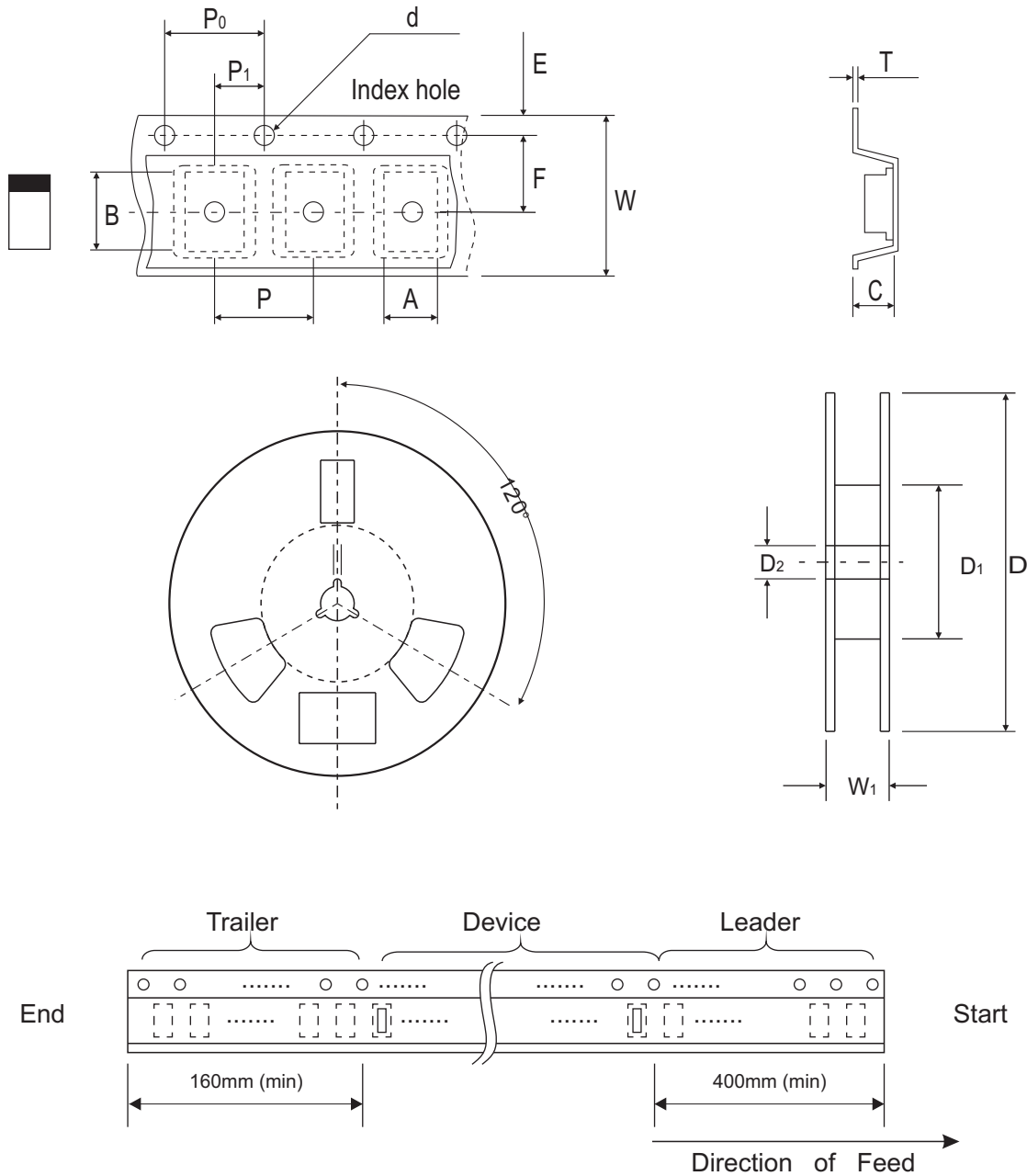

Fig.4 - Current Derating Curve



## Reel Taping Specification



1005 (SOD-323F)	SYMBOL	A	B	C	d	D	D <sub>1</sub>	D <sub>2</sub>
	(mm)	1.45 ± 0.05	2.80 ± 0.05	1.00 ± 0.05	1.50 + 0.10 - 0	178.00 ± 1.00	60.0 ± 0.50	13.50 ± 0.20
	(inch)	0.057 ± 0.002	0.110 ± 0.002	0.039 ± 0.002	0.059 + 0.004 - 0	7.008 ± 0.039	2.362 ± 0.020	0.531 ± 0.008

1005 (SOD-323F)	SYMBOL	E	F	P	P <sub>0</sub>	P <sub>1</sub>	T	W	W <sub>1</sub>
	(mm)	1.75 ± 0.10	3.50 ± 0.05	4.00 ± 0.10	4.00 ± 0.10	2.00 ± 0.05	0.23 ± 0.05	8.00 ± 0.10	12.00 + 0.50 - 0
	(inch)	0.069 ± 0.004	0.138 ± 0.002	0.157 ± 0.004	0.157 ± 0.004	0.079 ± 0.002	0.009 ± 0.002	0.315 ± 0.004	0.472 + 0.020 - 0