

## CDBHM120L-G Thru. CDBHM1100L-G

Reverse Voltage: 20 to 100 Volts

Forward Current: 1.0 Amp

RoHS Device

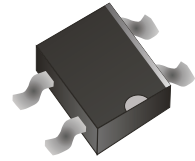

### Features

- High surge forward current capability.
- Low Forward voltage drop.
- General purpose 1 phase Bridge rectifier applications
- UL recognized file # E230084

### Mechanical data

- Case: molded plastic
- Epoxy: UL 94V-0 rate flame retardant.
- Lead: solder plated
- Polarity: As marked
- Weight: 0.125 gram(approx)

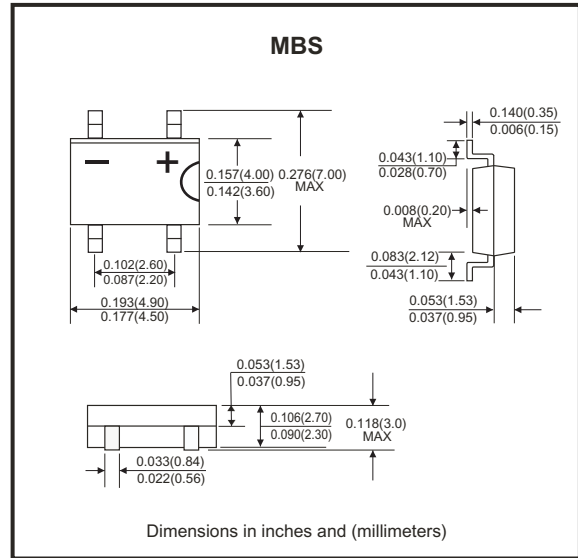

### Maximum Ratings and Electrical Characteristics

Rating at 25°C ambient temperature unless otherwise specified.  
Single phase, half wave, 60Hz resistive or inductive load.  
For capacitive load, derate current by 20%

Parameter	Symbol	Conditions	CDBHM-G					Units
			120L	140L	160L	180L	1100L	
Max. Repetitive peak reverse voltage	$V_{RRM}$		20	40	60	80	100	V
Max. DC blocking voltage	$V_{DC}$		20	40	60	80	100	V
Max. RMS voltage	$V_{RMS}$		14	28	42	56	70	V
Average rectified output current @60Hz sine wave, R-load, $T_A=25^\circ\text{C}$	$I_o$	On alumina substrate	1.0					A
		On glass-epoxi substrate	0.8					
Peak forward surge current, 8.3ms single half sine-wave superimposed on rated load (JEDEC method)	$I_{FSM}$		40					A
Max. Peak forward voltage	$V_{FM}$	$I_{FM}=0.5A$	0.55	0.65	0.85			V
Max. Peak reverse current	$I_{RRM}$	$V_{RM}=V_{RRM}$	0.5					mA
Max. Current Squared Time	$I^2t$	$1ms \leq t < 8.3ms$ $T_A=25^\circ\text{C}$	6.6					A <sup>2</sup> S
Max. Thermal resistance	$R_{\theta JA}^{(1)}$	On alumina substrate	76					°C/W
		On glass-epoxi substrate	134					
	$R_{\theta JL}$	Between junction and lead	20					
Operating temperature range	$T_J$		-55 to +150					°C
Storage temperature range	$T_{STG}$		-55 to +150					°C

Notes: 1. Between junction and ambient

Company reserves the right to improve product design , functions and reliability without notice.

REV: E

## Rating and Characteristics Curves (CDBHM120L-G Thru. CDBHM1100L-G)

Fig.1 - Forward Current Derating Curve

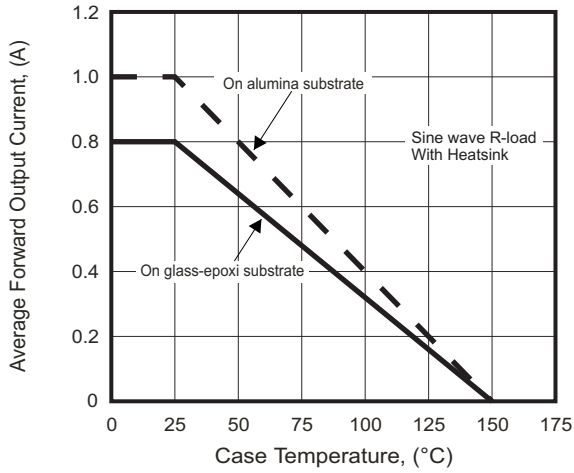

Fig.2 - Typical Forward Characteristics

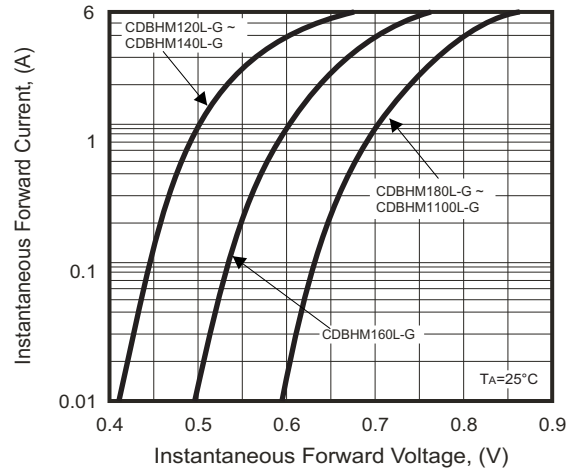

Fig.3 - Maximum Non-Repetitive Surge Current

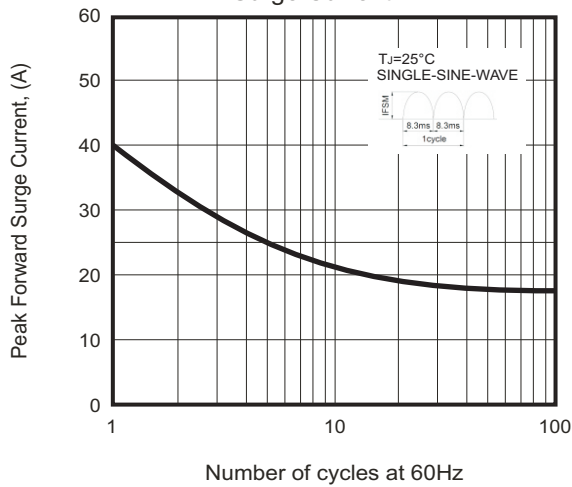
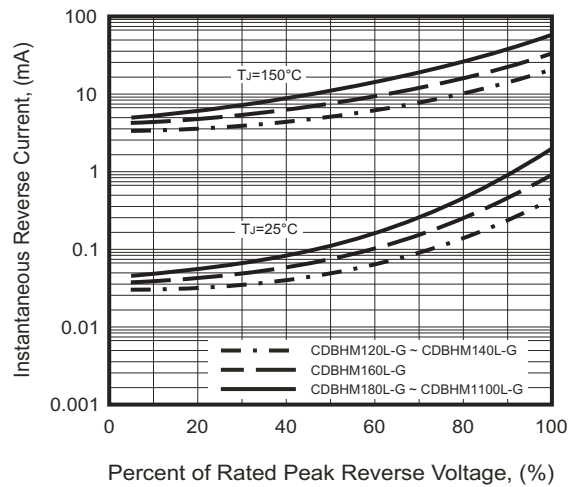
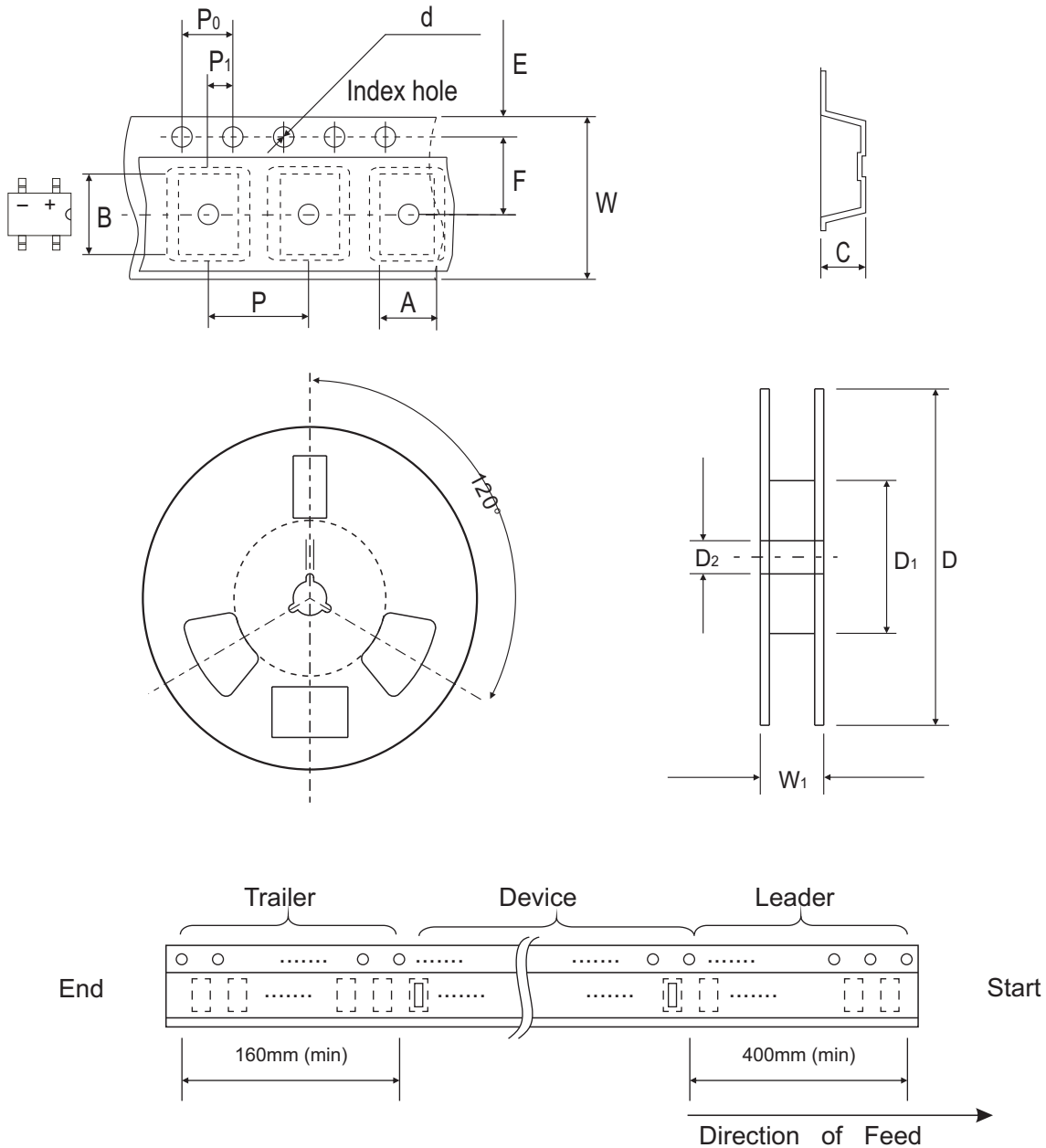

Fig.4 - Typical Reverse Characteristics



## Reel Taping Specification



MBS	SYMBOL	A	B	C	d	D	D1	D2
	(mm)	5.00 ± 0.10	7.24 ± 0.10	2.95 ± 0.10	1.55 ± 0.05	330.0 ± 2.00	50.0 Min.	13.0 ± 0.50
	(inch)	0.197 ± 0.004	0.285 ± 0.004	0.116 ± 0.004	0.061 ± 0.002	13.00 ± 0.079	1.969 Min.	0.512 ± 0.020

MBS	SYMBOL	E	F	P	P0	P1	W	W1
	(mm)	1.75 ± 0.10	5.50 ± 0.05	8.00 ± 0.10	4.00 ± 0.10	2.00 ± 0.10	12.00 ± 0.30	18.70 Max.
	(inch)	0.069 ± 0.004	0.217 ± 0.002	0.315 ± 0.004	0.157 ± 0.004	0.079 ± 0.004	0.472 ± 0.012	0.736 Max.

Company reserves the right to improve product design, functions and reliability without notice.

REV: E