

CDBMTS240-HF Thru. CDBMTS2200-HF

Reverse Voltage: 40 to 200 Volts

Forward Current: 2.0 Amp

RoHS Device

Halogen Free

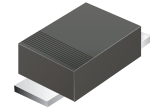

Features

- Excellent power dissipation offers better reverse leakage current and thermal resistance.
- Low profile surface mounted application in order to optimize board space.
- Low power loss, high efficiency.
- High current capability, low forward voltage drop.
- High surge capability.
- Guarding for overvoltage protection.
- Ultra high-speed switching.
- Silicon epitaxial planar chip, metal silicon junction.
- Lead-free part meets environmental standards of MIL-STD-19500/228

Mechanical data

- Epoxy: UL94V-0 rated flame retardant.
- Case: Molded plastic, SOD-123S/MINI SMA
- Terminals: Solderable per MIL-STD-750, Method 2026.
- Polarity: Indicated by cathode band.
- Mounting Position: any
- Weight: 0.0155 grams approx.

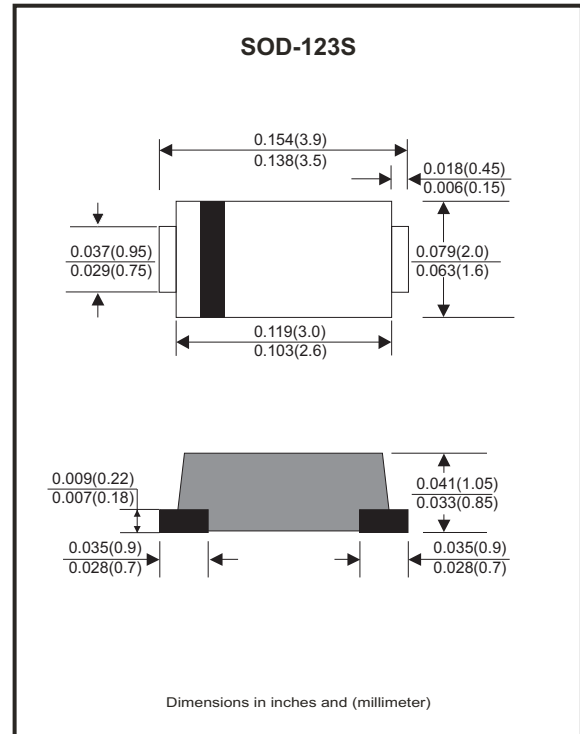

Maximum Ratings and Electrical Characteristics (at T_A=25°C unless otherwise noted)

Parameter	Symbol	CDBMTS 240-HF	CDBMTS 260-HF	CDBMTS 2100-HF	CDBMTS 2150-HF	CDBMTS 2200-HF	Unit
Repetitive peak reverse voltage	V _{RRM}	40	60	100	150	200	V
Continuous reverse voltage	V _R	40	60	100	105	140	V
RMS voltage	V _{RMS}	28	42	70	150	200	V
Maximum Forward rectified current	I _O	2.0					A
Maximum forward voltage @ I _F =2.0A	V _F	0.50	0.70	0.85	0.90	0.92	V
Maximum forward surge current 8.3ms single half sine-wave superimposed on rated load (JEDEC methode)	I _{FSM}	50					A
Maximum reverse Current (V _R =V _{RRM})	T _J =25°C	0.5					mA
	T _J =100°C	20					
Typical diode Junction capacitance (F=1MHz and applied 4V DC reverse voltage)	C _J	160					pF
Operating temperature	T _J	-55 to +125	-55 to +150				°C
Storage temperature range	T _{STG}	-65 to +175					°C

Company reserves the right to improve product design , functions and reliability without notice.

Rating and Characteristic Curves (CDBMTS240-HF Thru. CDBMTS2200-HF)

Fig.1 - Typical Forward Current Derating Curve

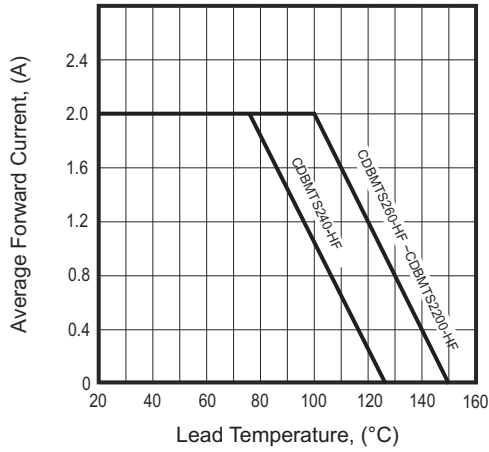

Fig.2 - Typical Forward Characteristics

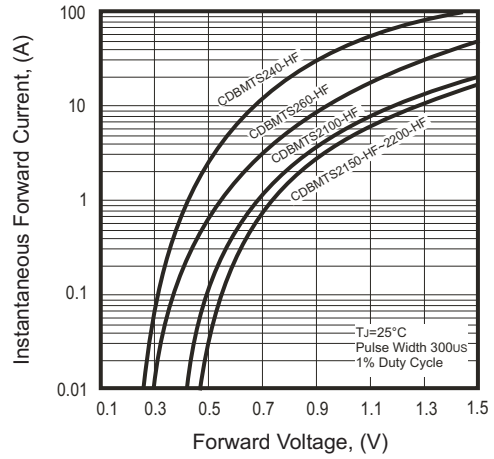

Fig.3 - Maximum Non-repetitive Forward Surge Current

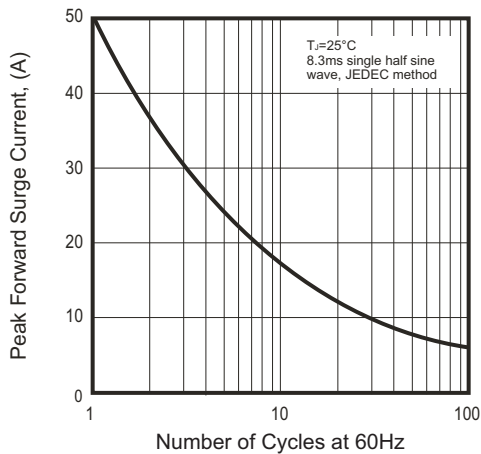

Fig.4 - Typical Junction Capacitance

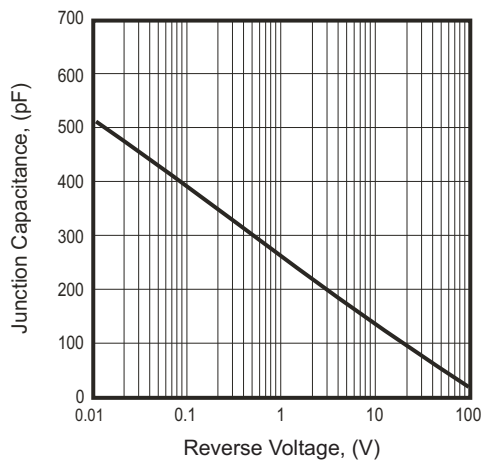
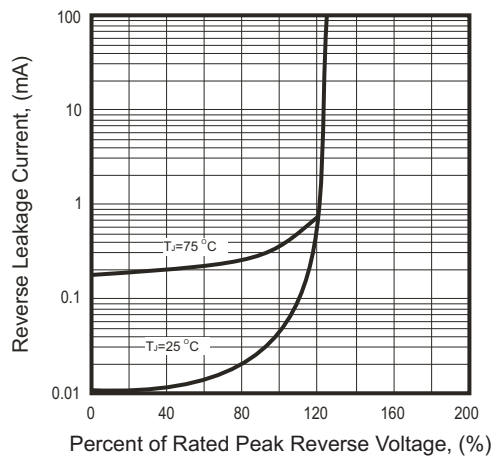
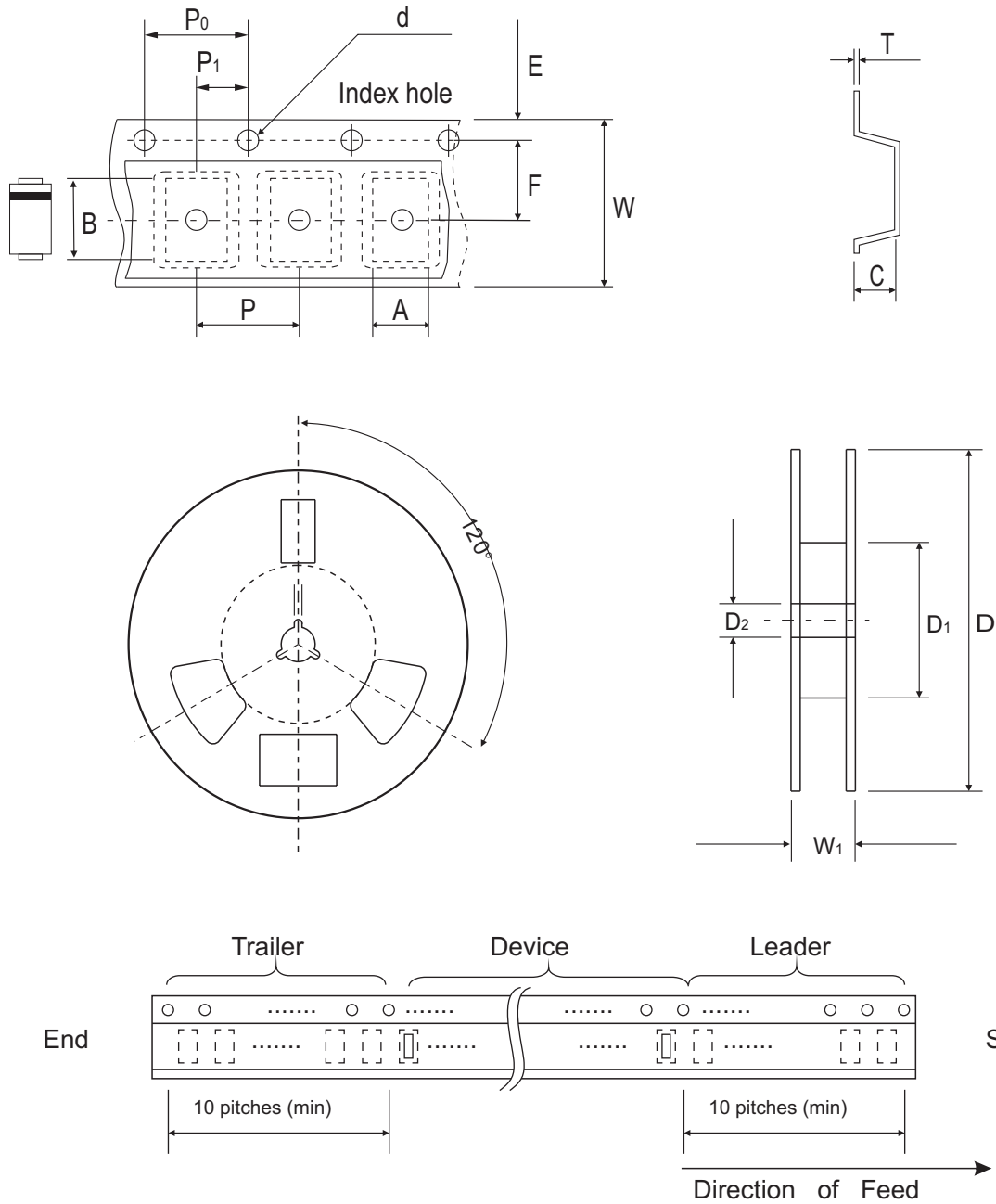

Fig.5 - Typical Reverse Characteristics



Reel Taping Specification



SOD-123S	SYMBOL	A	B	C	d	D	D1	D2
	(mm)	2.00 ± 0.10	3.85 ± 0.10	1.10 ± 0.10	1.50 ± 0.10	178 ± 2.00	62.0 MIN.	13.0 ± 0.50
	(inch)	0.079 ± 0.004	0.152 ± 0.004	0.043 ± 0.004	0.059 ± 0.004	7.00 ± 0.079	2.440 MIN.	0.512 ± 0.020

SOD-123S	SYMBOL	E	F	P	P0	P1	T	W	W1
	(mm)	1.75 ± 0.10	3.50 ± 0.10	4.00 ± 0.10	4.00 ± 0.10	2.00 ± 0.10	0.23 ± 0.10	8.00 ± 0.30	11.40 ± 1.0
	(inch)	0.069 ± 0.004	0.138 ± 0.004	0.157 ± 0.004	0.157 ± 0.004	0.079 ± 0.004	0.009 ± 0.004	0.315 ± 0.012	0.449 ± 0.039