

## CDBQR42/43-HF

**I<sub>o</sub> = 200 mA**  
**V<sub>R</sub> = 30 Volts**  
**RoHS Device**  
**Halogen Free**

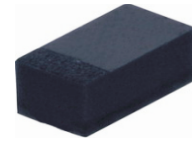

### Features

- Low forward voltage.
- Designed for mounting on small surface.
- Extremely thin/leadless package.
- Majority carrier conduction.

### Mechanical data

- Case: 0402/SOD-923F standard package, molded plastic.
- Terminals: Gold plated, solderable per MIL-STD-750, method 2026.
- Marking code:  
 CDBQR42-HF : BD  
 CDBQR43-HF : BE
- Mounting position: Any
- Weight: 0.001 gram(approx.).

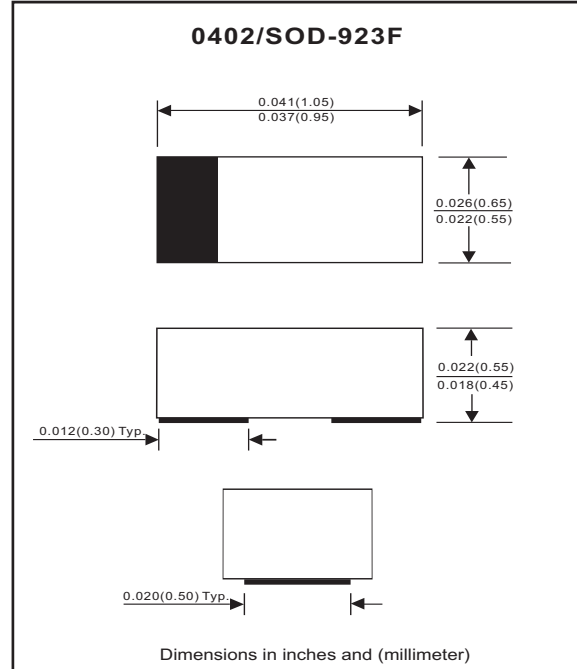

### Maximum Rating (at TA=25°C unless otherwise noted)

Parameter	Conditions	Symbol	Min	Typ	Max	Unit
Peak reverse voltage		V <sub>RM</sub>			30	V
Reverse voltage		V <sub>R</sub>			30	V
RMS reverse voltage		V <sub>R(RMS)</sub>			21	V
Average forward rectified current		I <sub>O</sub>			200	mA
Repetitive peak forward current		I <sub>FRM</sub>			0.5	A
Forward current,surge peak	8.3 ms single half sine-wave superimposed on rate load(JEDEC method)	I <sub>FSM</sub>			4	A
Power dissipation		P <sub>D</sub>			125	mW
Thermal resistance junction to ambient air		R <sub>θJA</sub>			667	°C/W
Storage temperature		T <sub>STG</sub>	-55		+125	°C
Junction temperature		T <sub>J</sub>			+125	°C

### Electrical Characteristics (at TA=25°C unless otherwise noted)

Parameter	Conditions	Symbol	Min	Typ	Max	Unit
Forward voltage CDBQR42/43-HF CDBQR42-HF CDBQR42-HF CDBQR43-HF CDBQR43-HF	I <sub>F</sub> = 200mA I <sub>F</sub> = 10mA I <sub>F</sub> = 50mA I <sub>F</sub> = 2mA I <sub>F</sub> = 15mA	V <sub>F</sub>			1 0.4 0.65 0.33 0.45	V
Reverse current	V <sub>R</sub> = 25V	I <sub>R</sub>			0.5	uA
Capacitance between terminals	f = 1 MHz, and 1 VDC reverse voltage	C <sub>T</sub>			10	pF
Reverse recovery time	I <sub>F</sub> =I <sub>R</sub> =10mA,I <sub>rr</sub> =0.1xI <sub>R</sub> ,R <sub>L</sub> =100 ohm	T <sub>rr</sub>			5	nS

## RATING AND CHARACTERISTIC CURVES (CDBQR42/43-HF)

Fig. 1 - Forward characteristics

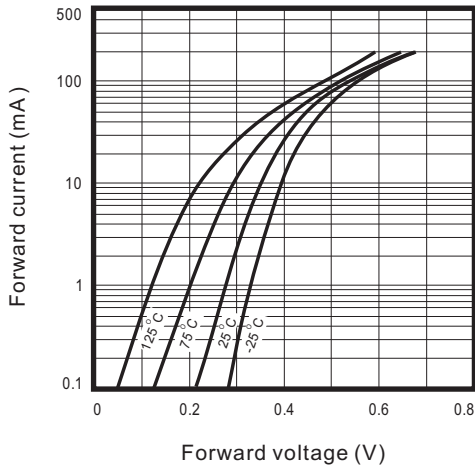

Fig. 2 - Reverse characteristics

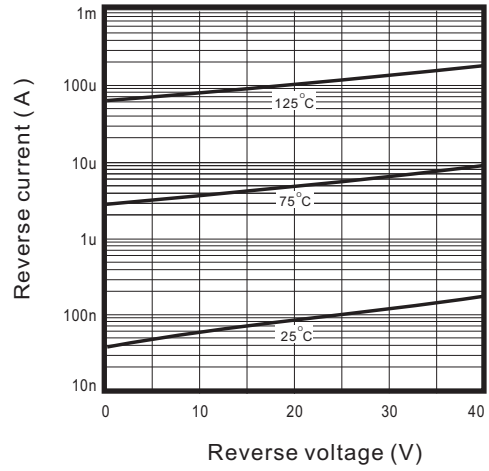

Fig.3 - Capacitance between terminals characteristics

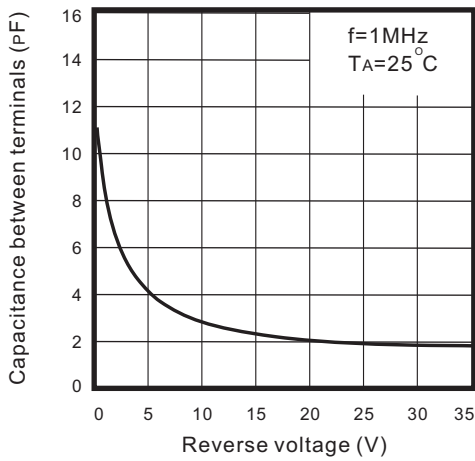
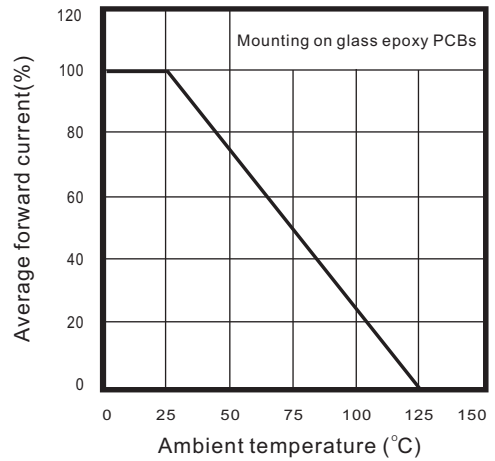
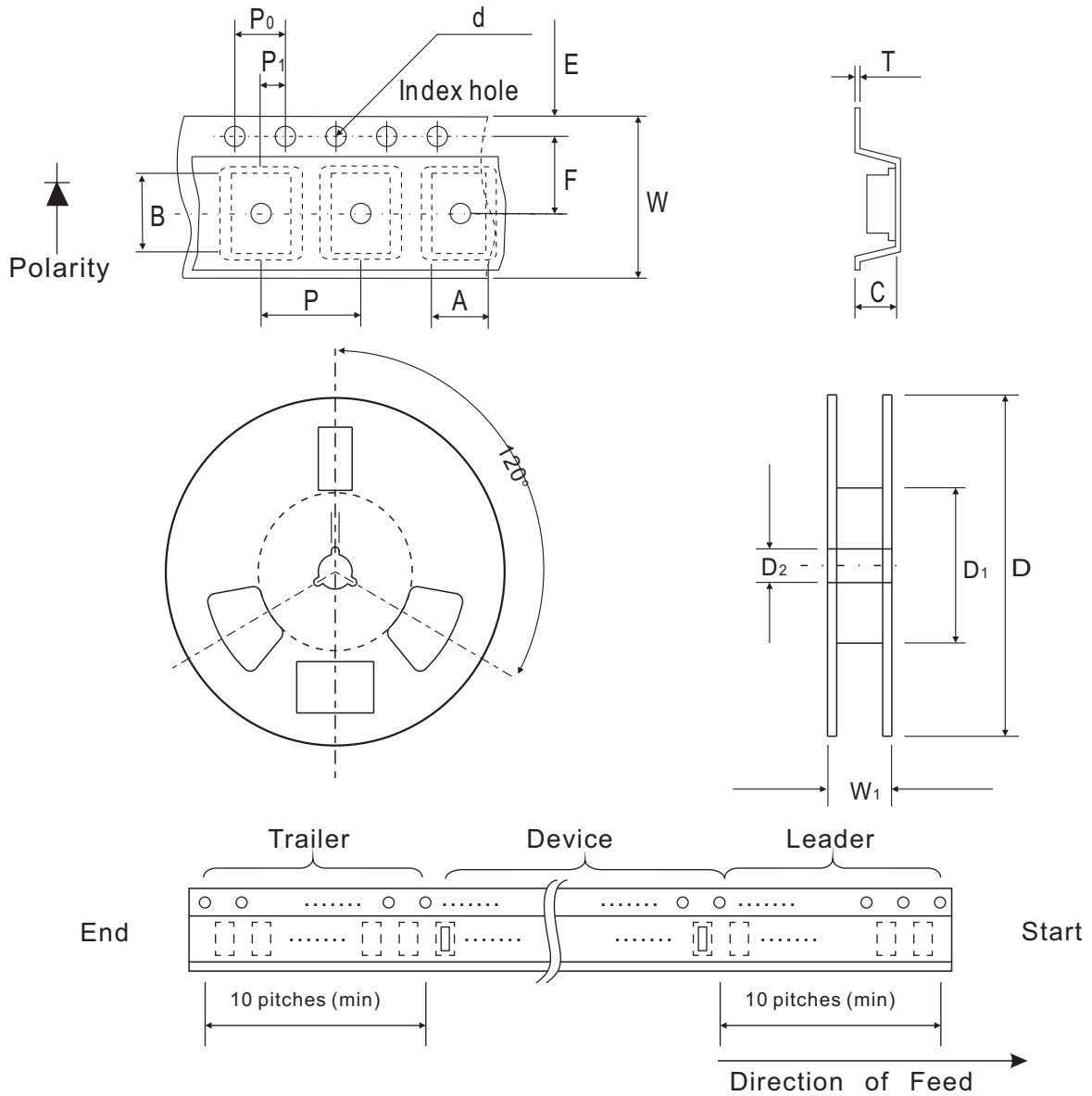

Fig.4 - Current derating curve



## Reel Taping Specification



0402 (SOD-923F)	SYMBOL	A	B	C	d	D	D <sub>1</sub>	D <sub>2</sub>
	(mm)	0.75 ± 0.10	1.15 ± 0.10	0.60 ± 0.10	1.55 + 0.10	178 ± 1	60.0 MIN.	13.0 ± 0.20
	(inch)	0.026 ± 0.004	0.045 ± 0.004	0.024 ± 0.004	0.061 + 0.004	7.008 ± 0.04	2.362 MIN.	0.512 ± 0.008

0402 (SOD-923F)	SYMBOL	E	F	P	P <sub>0</sub>	P <sub>1</sub>	T	W	W <sub>1</sub>
	(mm)	1.75 ± 0.10	3.50 ± 0.05	4.00 ± 0.10	4.00 ± 0.10	2.00 ± 0.10	0.22 ± 0.05	8.00 ± 0.20	13.5 MAX.
	(inch)	0.069 ± 0.004	0.138 ± 0.002	0.157 ± 0.004	0.157 ± 0.004	0.079 ± 0.004	0.009 ± 0.002	0.315 ± 0.008	0.531 MAX.