

## CDBT-70/S/C/A-G

Reverse Voltage: 70 Volts

Forward Current: 70 mA

RoHS Device

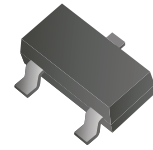

### Features

- Design for mounting on small surface.
- High speed switching application, circuit protection.
- Low turn-on voltage.

### Mechanical data

- Case: SOT-23, molded plastic.
- Terminals: solderable per MIL-STD-750, method 2026.
- Approx. weight: 0.008 grams

### Circuit diagram

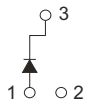

CDBT-70-G

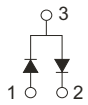

CDBT-70S-G

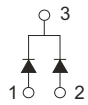

CDBT-70C-G

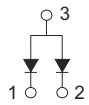

CDBT-70A-G

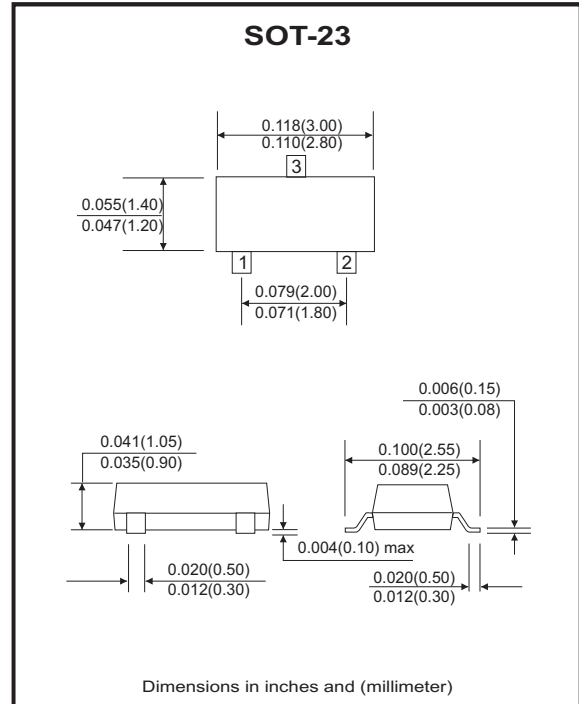

### Maximum Ratings and Electrical Characteristics

(at Ta=25°C unless otherwise noted)

Parameter	Symbol	Conditions	Value	Units
Repetitive peak reverse voltage	$V_{RRM}$		70	V
Reverse voltage	$V_R$		70	V
Forward continuous current	$I_F$		70	mA
Non-Repetitive peak forward surge current	$I_{FSM}$	T=1.0 sec	100	mA
Power dissipation	$P_D$		200	mW
Maximum forward voltage	$V_F$	@ $I_F=1.0mA$ @ $I_F=15mA$	410 1000	mV
Maximum reverse leakage current	$I_R$	@ $V_R=50V$	100	nA
Maximum reverse recovery time	$T_{rr}$	$I_F=I_R=10mA, R_L=100\Omega, I_{rr}=0.1*I_R$	5	nS
Maximum diode capacitance	$C_D$	$V_R=0V, f=1.0MHz$	2	pF
Thermal Resistance Junction to Ambient	$R_{\theta JA}$		500	°C/W
Junction temperature	$T_J$		125	°C
Storage temperature	$T_{STG}$		-55 to +150	°C

Company reserves the right to improve product design, functions and reliability without notice.

REV:B

## RATING AND CHARACTERISTIC CURVES (CDBT-70/S/C/A-G)

Fig.1 - Forward Characteristics

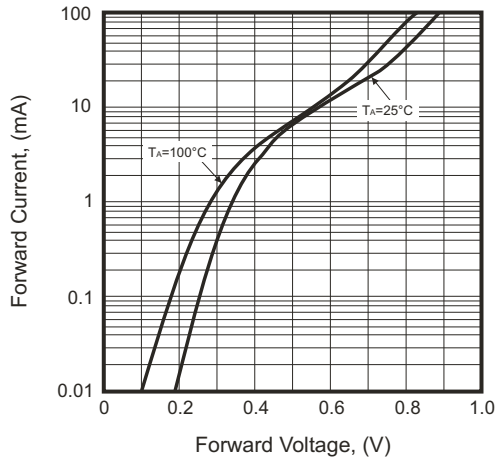

Fig.2 - Reverse Characteristics

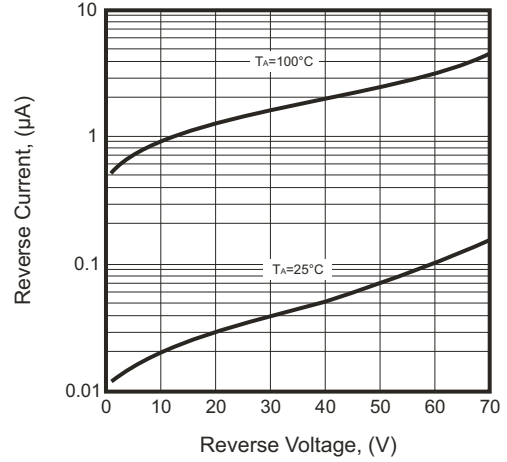

Fig.3 - Capacitance Characteristics

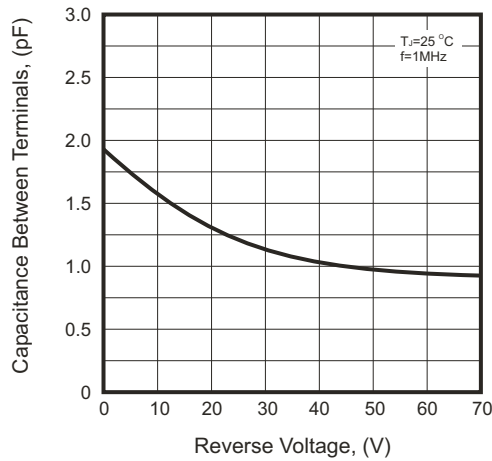

Fig.4 - Power Derating Curve

