

## CDBV6-54T/AD/CD/SD/BR-G

Forward Current: 0.2A

Reverse Voltage: 30V

RoHS Device

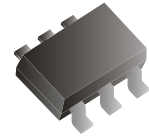

### Features

- Low forward voltage drop.
- Fast switching.
- Ultra-small surface mount package.
- PN junction guard ring for transient and ESD protection.
- Available in lead Free version.

### Mechanical data

- Case: SOT-363, Molded Plastic
- Case material: UL 94V-0 flammability retardant classification.
- Terminals: Solderable per MIL-STD-202, Method 208
- Marking: Orientation: See diagrams below
- Weight: 0.006 grams (approx.)
- Marking: See diagrams below

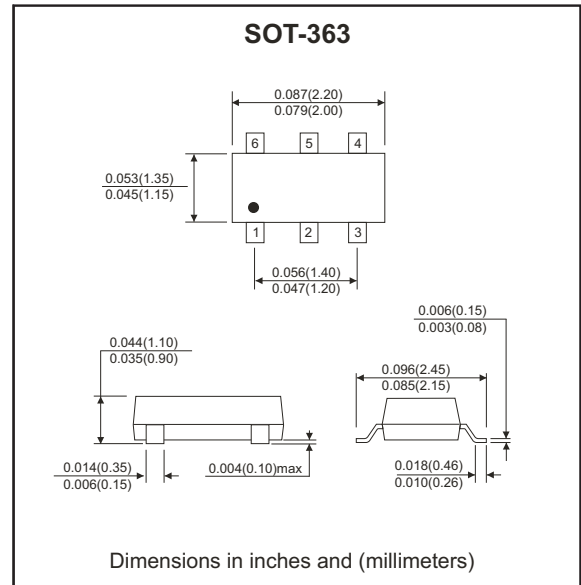

### Circuit Diagram

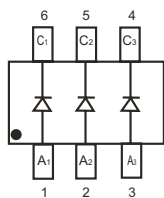

CDBV6-54T-G  
Marking: KLA

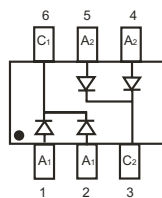

CDBV6-54CD-G\*  
Marking: KL7

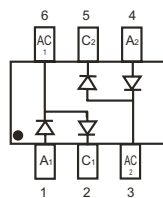

CDBV6-54SD-G\*  
Marking: KL8

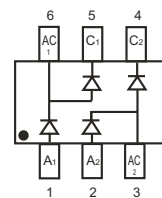

CDBV6-54BR-G  
Marking: KLB

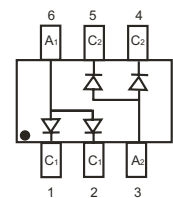

CDBV6-54AD-G\*  
Marking: KL6

\*Symmetrical configuration, no orientation indicator.

### Maximum Ratings (Ta=25°C unless otherwise noted)

Parameter	Symbol	Value	Unit
Repetitive peak reverse voltage	$V_{RRM}$	30	V
Peak working reverse voltage	$V_{RWM}$		
DC blocking voltage	$V_R$		
RMS reverse voltage	$V_{R(RMS)}$	21	V
Forward continuous current	$I_o$	200	mA
Repetitive peak forward current	$I_{FRM}$	300	
Non-repetitive peak forward surge current @ t=8.3ms	$I_{FSM}$	600	
Power dissipation	$P_D$	200	mW
Thermal resistance from junction to ambient	$R_{\theta JA}$	500	°C/W
Junction temperature range	$T_J$	-40 ~ +125	°C
Storage temperature range	$T_{STG}$	-55 ~ +150	°C

## Electrical Characteristics (Ta=25°C unless otherwise noted)

Parameter	Symbol	Conditions	Min.	Typ.	Max.	Unit
Reverse voltage	$V_{(BR)}$	$I_R = 100\mu A$	30			V
Reverse current	$I_R$	$V_R = 25V$			2	$\mu A$
Forward voltage	$V_F$	$I_F = 1mA$			320	mV
		$I_F = 10mA$			400	
		$I_F = 30mA$			500	
		$I_F = 100mA$			1000	
Total capacitance	$C_{tot}$	$V_R = 1V, f = 1MHz$			10	pF
Reverse recovery time	$t_{rr}$	$I_F = I_R = 10mA, I_{rr} = 0.1 \times I_R, R_L = 100\Omega$			5	ns

## ELECTRICAL CHARACTERISTIC CURVES ( CDBV6-54AD/CD/SD/BR/T-G)

Fig.1 - Typical Forward Characteristics

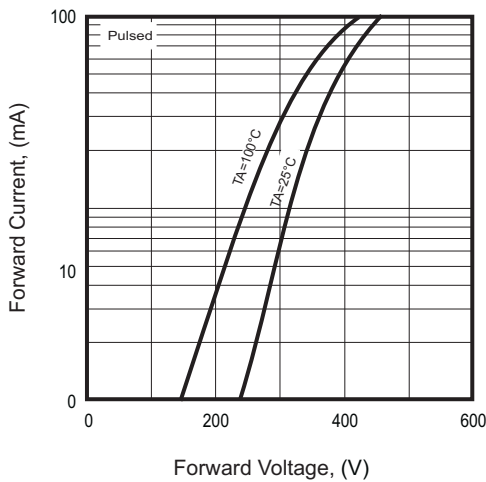

Fig.2 - Typical Reverse Characteristics

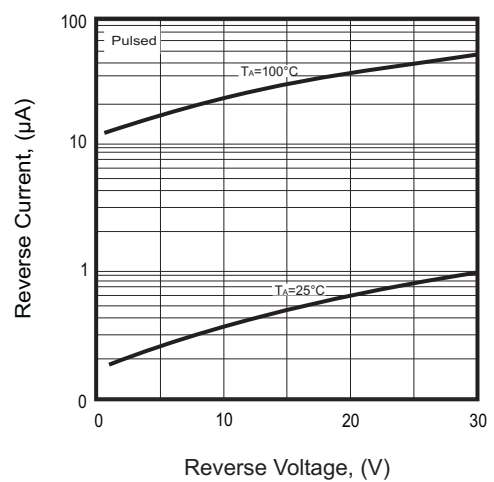

Fig.3 - Typical Capacitance Characteristics

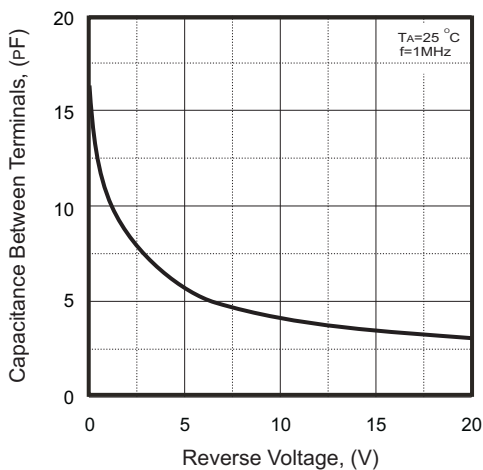
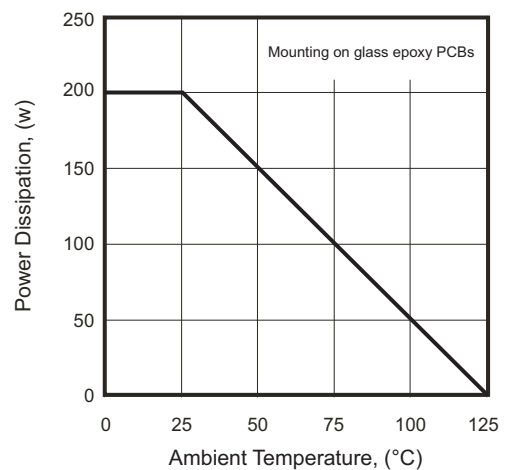
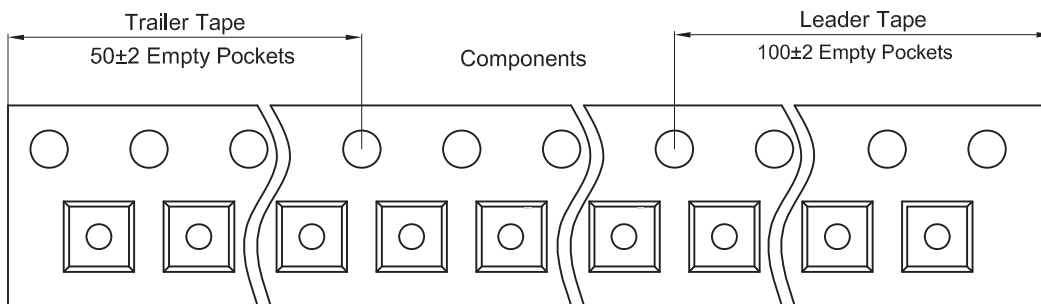
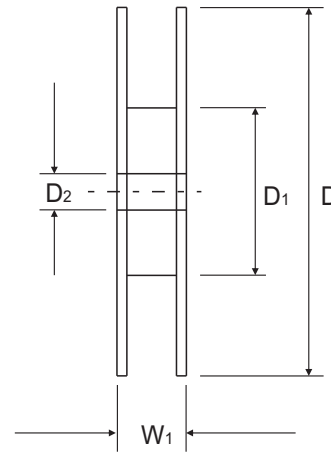
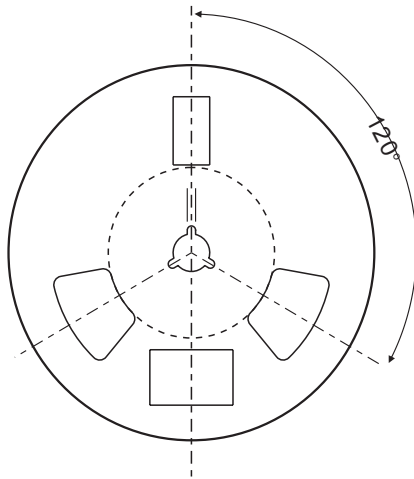
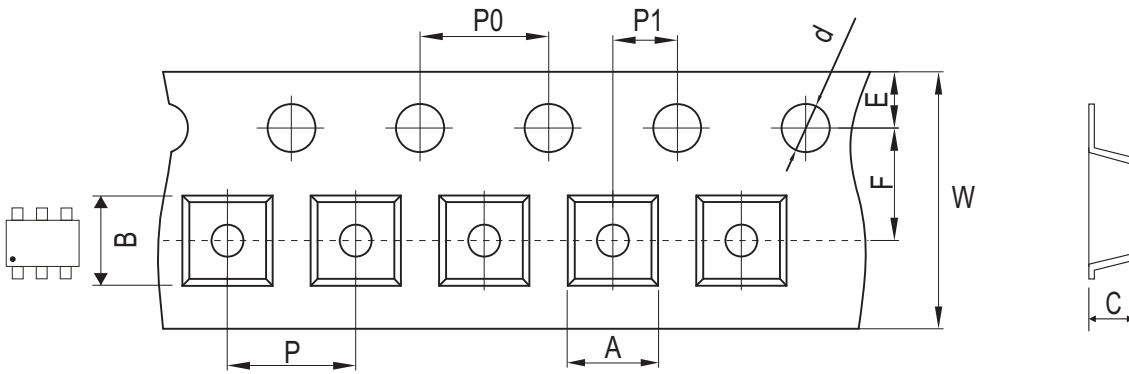

Fig.4 - Typical Power Derating Curve



## Reel Taping Specification



SOT-363	SYMBOL	A	B	C	d	D	D1	D2
	(mm)	2.25 ± 0.05	2.55 ± 0.05	1.20 ± 0.05	1.50 ± 0.10	178.00 ± 2.00	54.40 ± 1.00	13.00 ± 1.00
	(inch)	0.089 ± 0.002	0.100 ± 0.002	0.047 ± 0.002	0.059 ± 0.004	7.008 ± 0.079	2.142 ± 0.039	0.512 ± 0.039

SOT-363	SYMBOL	E	F	P	P0	P1	W	W1
	(mm)	1.75 ± 0.10	3.50 ± 0.10	4.00 ± 0.10	4.00 ± 0.10	2.00 ± 0.10	8.00 + 0.30/-0.10	12.30 ± 1.00
	(inch)	0.069 ± 0.004	0.138 ± 0.004	0.157 ± 0.004	0.157 ± 0.004	0.079 ± 0.004	0.315 + 0.012/-0.004	0.484 ± 0.039