

**MODEL:** CDS-5085-32-SP | **DESCRIPTION:** SPEAKER**FEATURES**

- 32 Ohm
- rated 0.5 W
- solder pads

**SPECIFICATIONS**

parameter	conditions/description	min	typ	max	units
input power	max power: 1 minute on, 2 minutes off, 10 cycles		0.5	1.0	W
impedance	at 2.0 kHz, 1.0 V	27.2	32	36.8	$\Omega$
resonant frequency (Fo)	at 1.0 V	320	400	480	Hz
frequency response		Fo		20,000	Hz
sound pressure level	at 0.1 W, 0.1 m, avg at 0.6, 0.8, 1.0, 1.2 kHz in baffleboard	89	92	95	dB
distortion	at 1.0 kHz, rated power			5	%
buzz, rattle, etc.	must be normal at sine wave, between Fo ~ 10,000 Hz			4.0	V
polarity	cone moves forward w/ positive dc current to "+" terminal				
dimensions	$\varnothing$ 50 x 8.5				mm
magnet	Nd-Fe-B				
frame material	SPCC				
cone material	PET (clear)				
terminal	solder pads				
weight			13.2		g
operating temperature		-20		60	$^{\circ}$ C
storage temperature		-30		70	$^{\circ}$ C
hand soldering	for maximum 2 seconds			380	$^{\circ}$ C
RoHS	yes				

Notes: 1. All specifications measured at 15~35 $^{\circ}$ C, humidity at 45~85%, under 86~106 kPa pressure, unless otherwise noted.

## MECHANICAL DRAWING

units: mm  
tolerance:  $\pm 0.5$  mm

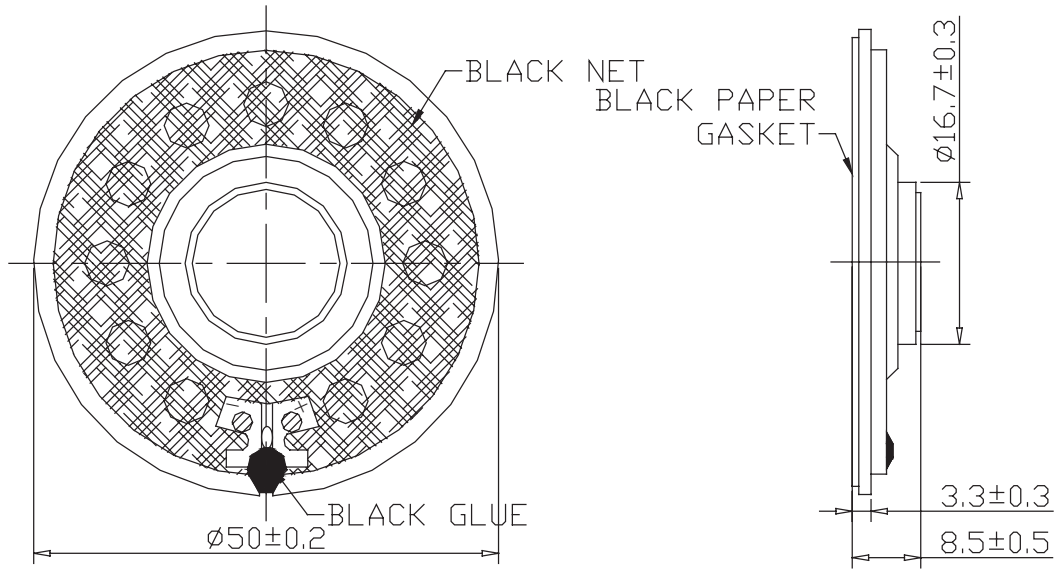

## FREQUENCY RESPONSE CURVE

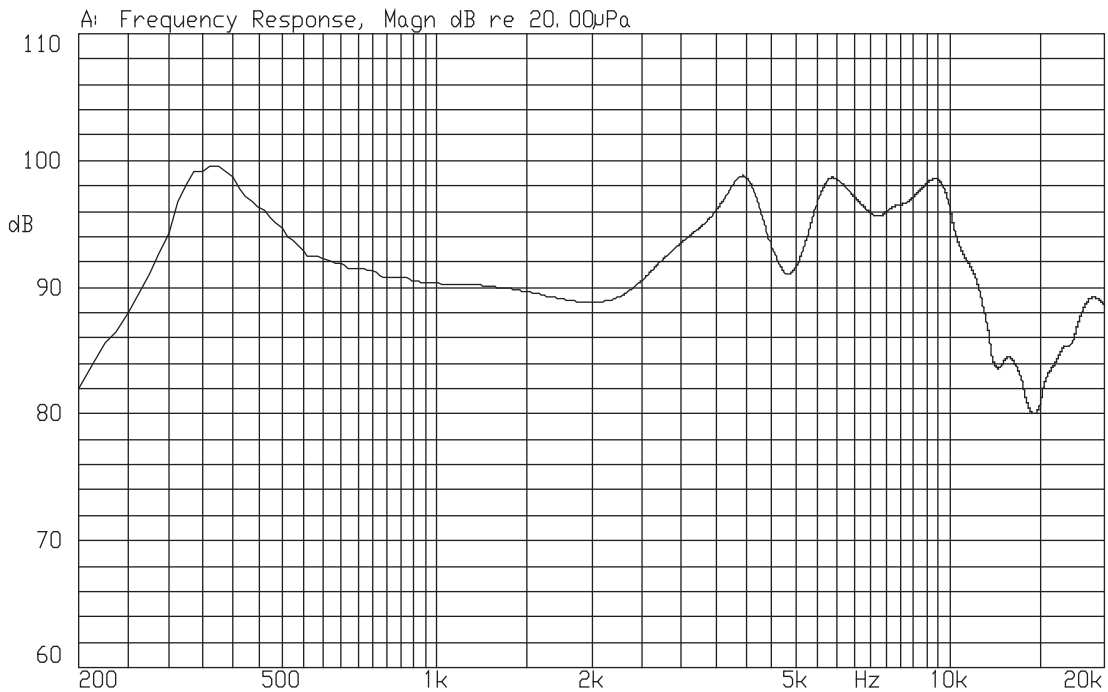

## PACKAGING

units: mm

Tray QTY: 50 pcs per tray  
 Carton Size: 590 x 300 x 310 mm  
 Carton QTY: 500 pcs per carton

50PCS

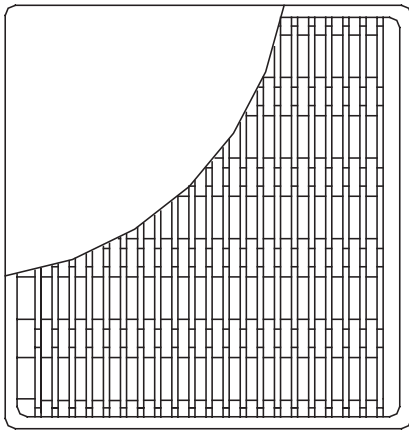

50PCSx5=250PCS

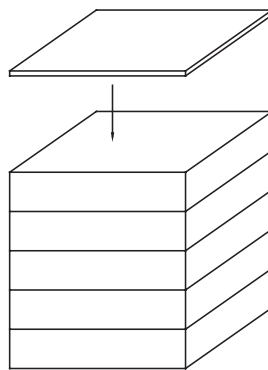

250PCSx2=500PCS

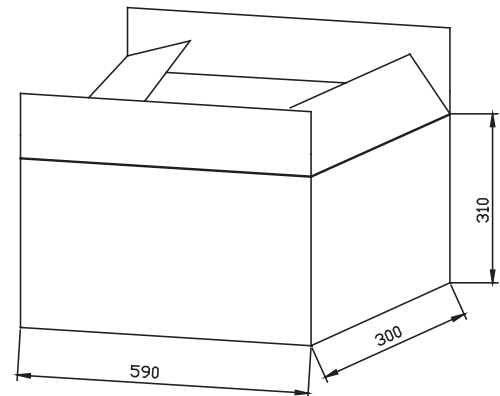
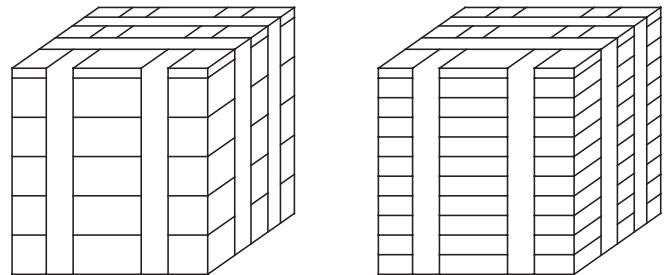

TO:

C/N /

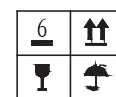

MODEL:	
QTY:	PCS
N.W:	kg
G.W:	kg
SIZE:	59 x 30 x 31 cm
LOT NO	