

RUGGED VPX

MEDIA & PROTOCOL CONVERSION MODULES

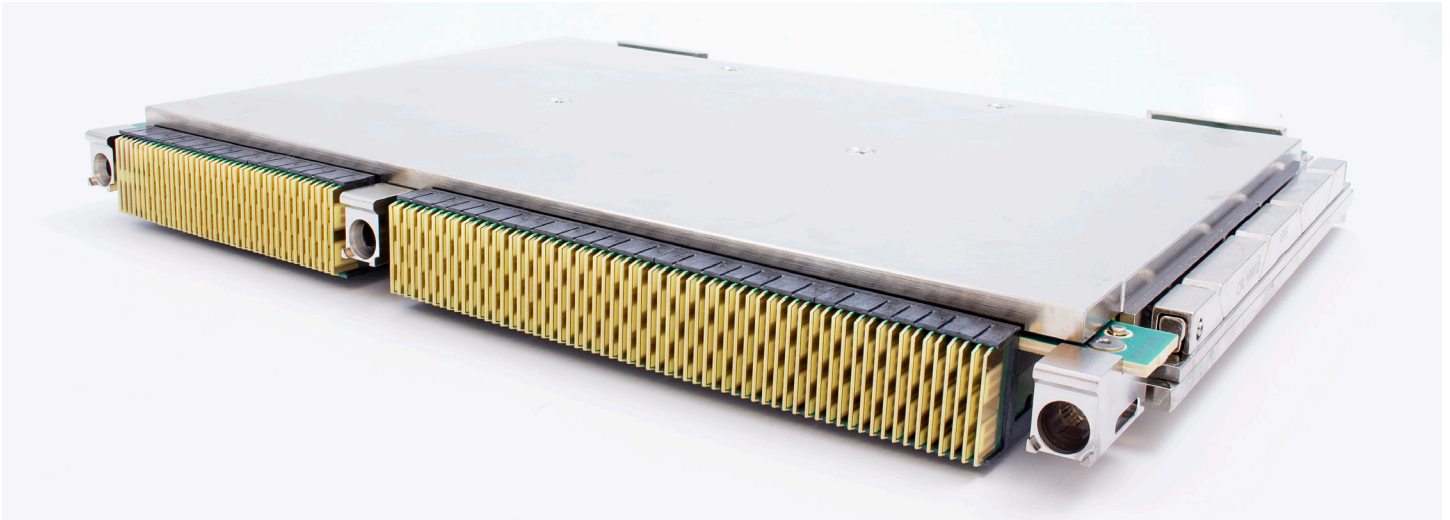

DESCRIPTION

Amphenol Aerospace is the world's leader in high-end performance interconnect products for rugged environment markets. Media and protocol conversion is an important capability enabling system connectivity from commercial off-the-shelf switches, processors, and I/O boards. This new line of VPX media conversion products provides the sweet spot of conversion from both backplane and Base-T connections, as well as backplane and high-end fiber connections. The product suite includes the components needed to quickly integrate this unit into a new sub-system, as well as install and field in rugged environments. By utilizing this architecture as a starting point, new derivatives that support specific requirements can easily be made, ensuring high-technology readiness and low-development costs.

FEATURES AND BENEFITS

- Embedded and integrated set of media and protocol conversion VPX boards for open systems architectures in the military rugged market
- Providing connectivity for 1G, 10G, and up to 40G Ethernet with Base-T and Fiber Base-SR conversion circuitry
- 3U and 6U VPX modules have corresponding internal sub-system connectors/cables as well as full test and integration set of products
- For plug and play integration with COTS VPX CPUs, Switches, and other devices
- New derivatives can be formed to meet new customer requirements
- Full diagnostics and control interfaces for built in test and alternate configurations

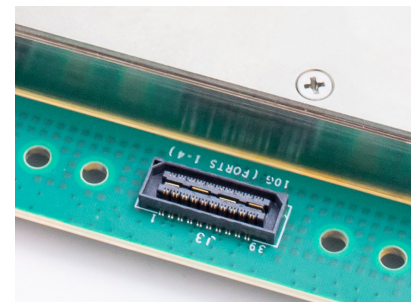
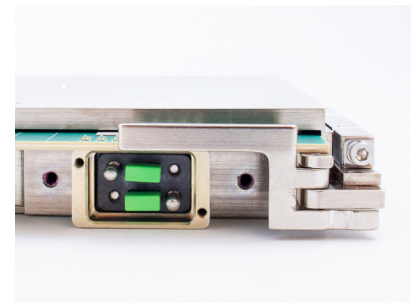

SUITE OF PRODUCTS

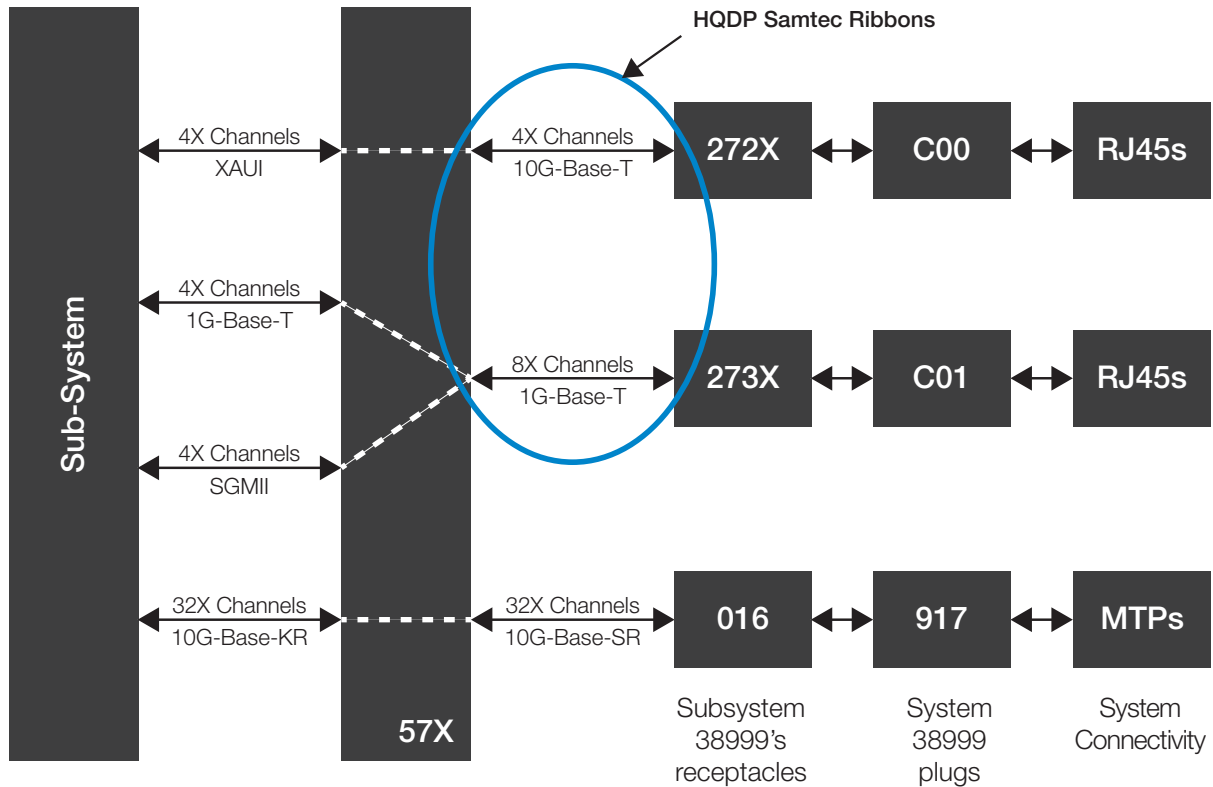

Part Number	Description
CF-020010-57X	6U VPX converter with 4X XAUI/10G-Base-T, 4X SGMII/1G-Base-T, 32X 10G-Base-SR, 12C, MDIO, LEDs
CF-020010-58X	6U VPX converter with 2X XAUI/10G-Base-T, 4X SGMII/1G-Base-T, MDIO, LEDs
CF-020010-721	6U VPX converter with 6X XAUI/10G-Base-T, 4X SGMII/1G-Base-T, MDIO, LEDs
CF-020011-438	6U VPX converter with 8X XAUI/10G-Base-T, 8X SGMII/1G-Base-T, MDIO, LEDs, Dual Redundant Power Supplies, 2X XMC sites for expansion
CF-020011-433	6U VPX converter with 8X XAUI/10G-Base-SR, 8X SGMII/1G-Base-SX, MDIO, I2C, LEDs
CF-020010-720	3U VPX converter with 2X XAUI/10G-Base-T, 8X SGMII/1G-Base-T, 24X 10G-Base-KR/SR, 12C, MDIO, LEDs
10-646402-272X	MIL-DTL-38999 size 19 receptacle with 4X Octonet contacts and mating PC board for Samtec connectivity to VPX boards
10-646402-273X	MIL-DTL-38999 size 25 receptacle with 8X Octonet contacts and mating PC board for Samtec connectivity to VPX boards
CA-628485-C00	MIL-DTL-38999 plug cable assembly for the 272X which breaks out Octonet contacts into RJ-45s
CA-628485-C01	MIL-DTL-38999 plug cable assembly for the 272X which breaks out Octonet contacts into RJ-45s
CF-901201-016	MIL-DTL-38999 dual receptacle MT cable assembly for connection to 57X fiber ports. Each MT has 16 channels of 10G-Base-SR.
CF-901200-017	MIL-DTL-38999 plug MT cable assembly for connection to each receptacle on the CF-901201-016 and breakouts to MTP contacts
CF-980062-061	Quad RJ45 breakout board for the Samtec headers on the 57X and 58X VPX modules

VPX MEDIA CONVERTER MODULE SUMMARY

CF-020010-57X

VITA 48.2 conduction cooled 6U VPX module with 1 inch pitch :

- 6Ux160mm form factor as defined by IEEE 1101.2 for conduction cooling
- VITA 46 board connectors
- IEEE 1101.2 extraction levers and performance wedge locks
- 3X - Samtec HQDP connectors for 1G-Base-T, 10G-Base-T
- 2X - 48 pin MT contacts for 40G-Base-SR4 / 10G-Base-SR

Copper Conversion formats:

- 4X Channels – XAUI to 10G-Base-T Conversion
- 4X Channels – SGMII to 1G-Base-T Conversion
- 4X Channels – 1G-Base-T pass through from VPX to Samtec
- Diagnostics interface is MDIO interface as well as LEDs per each channel

Fiber Conversion formats:

- 32X Channels – 10G-Base-KR to 10G-Base-SR
- Can be ganged together for 8X channels – 40G-Base-KR4 to 40G-Base-SR4
- Diagnostics interface is I2C interface as well as LEDs per each channel
- 10.3 (25 Gbps transceivers 850nm multimode optics)

Environmental Performance:

- Rugged storage and operating temperature range
- Typical vibration specifications in accordance with MIL-STD-810
- Typical power level is 36 Watts on 12Volts or 5Volts
- Integrated system reset function

57X Block Diagram

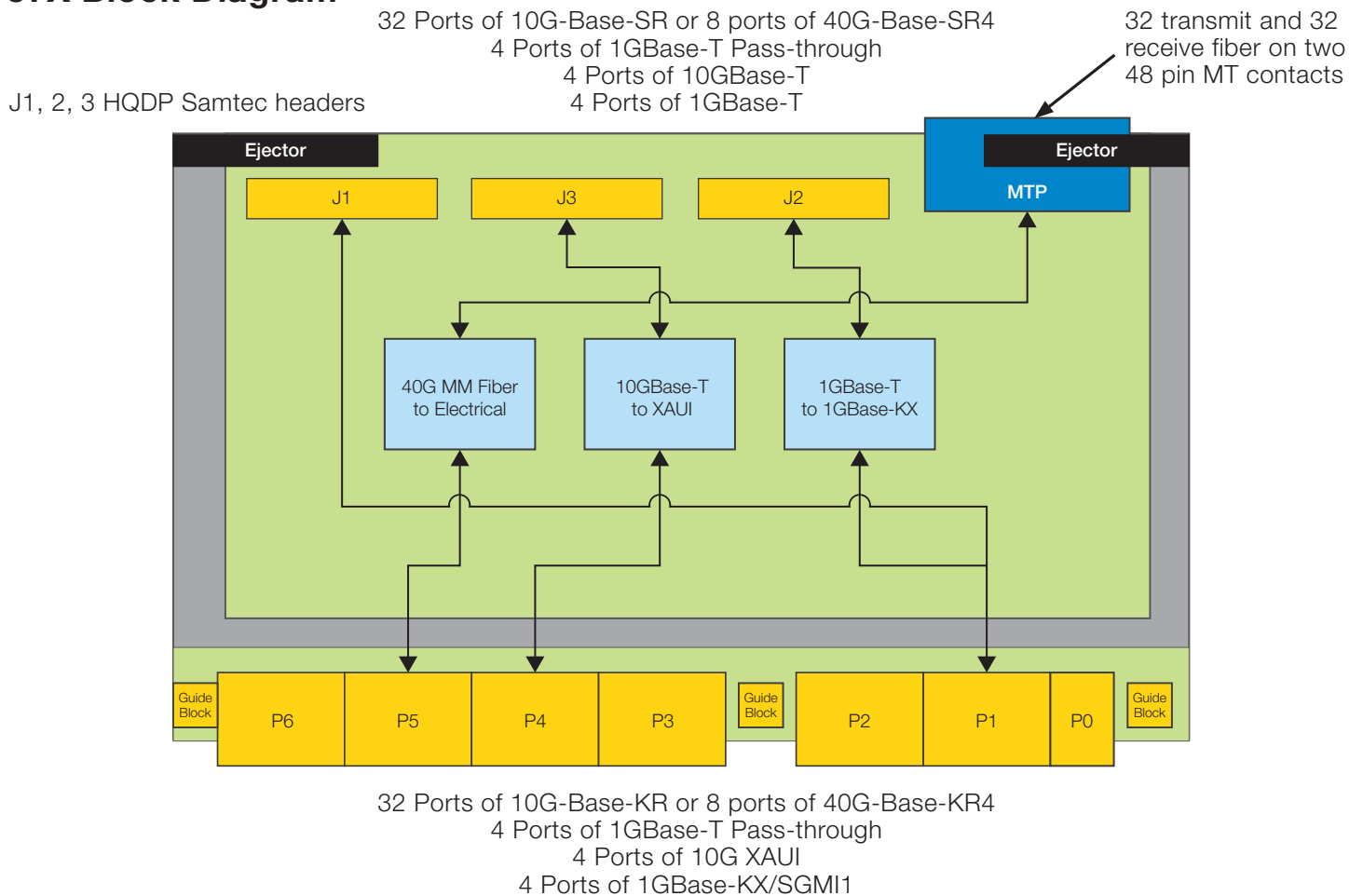

VPX MEDIA CONVERTER MODULE SUMMARY

CF-020010-57X

57X Drawing

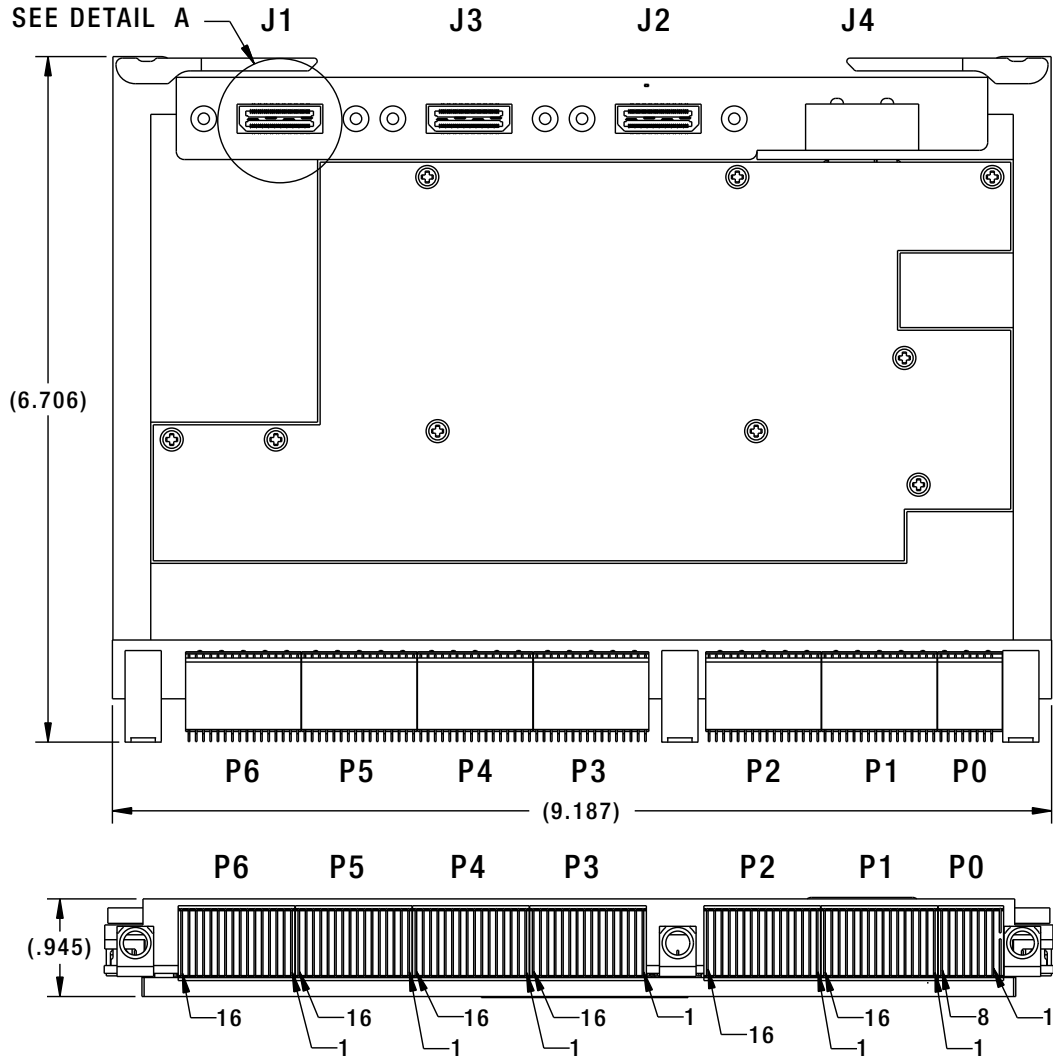

* Pinout data available in drawings by request

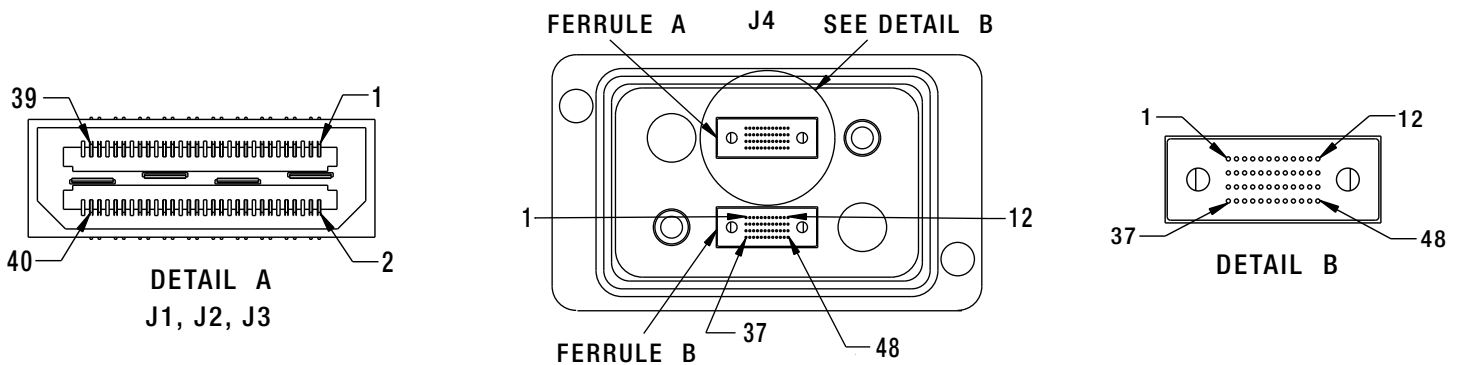
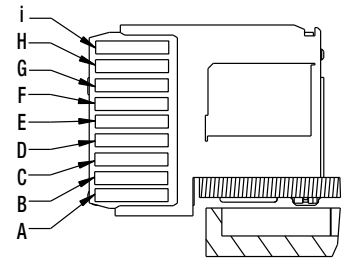

COMPLIMENTARY PRODUCT:

10-646402-272X

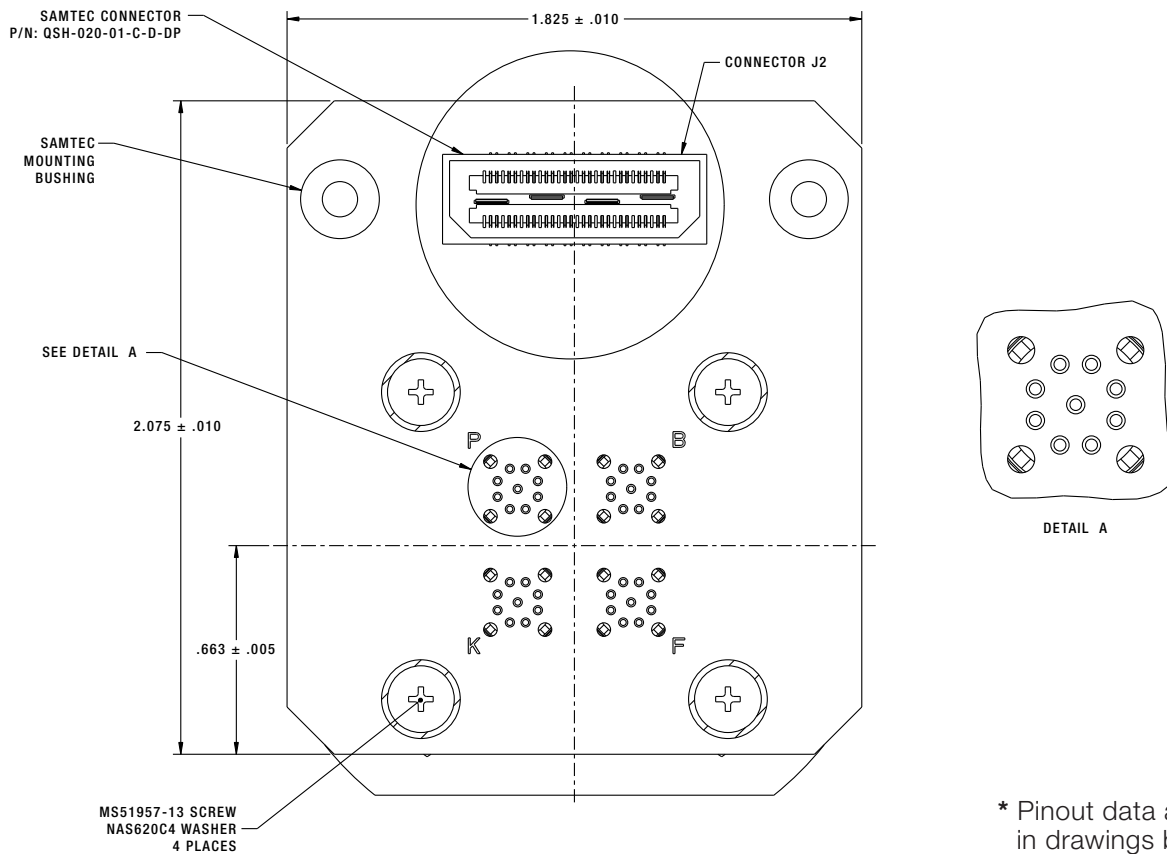
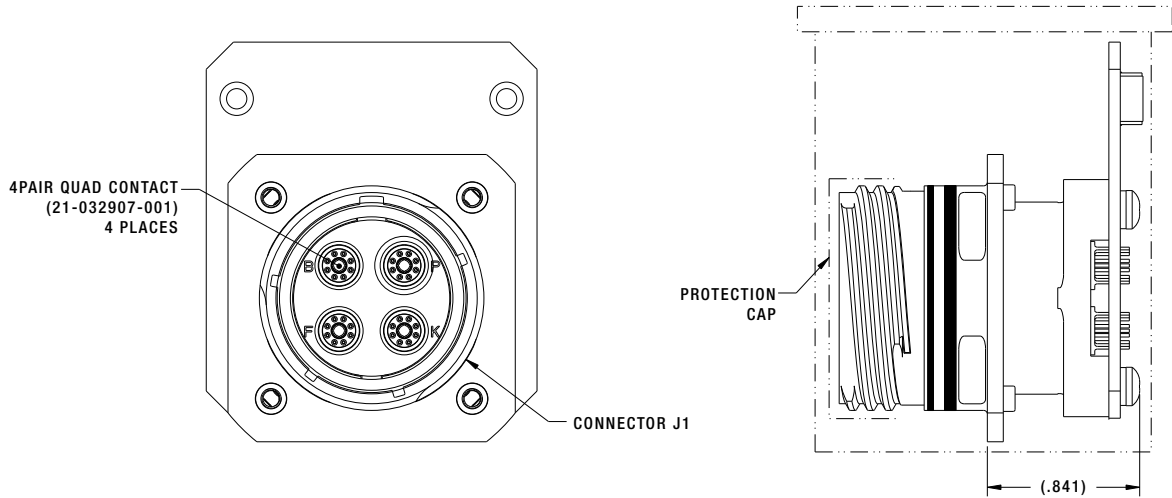

COMPLIMENTARY PRODUCT:

10-646402-273X

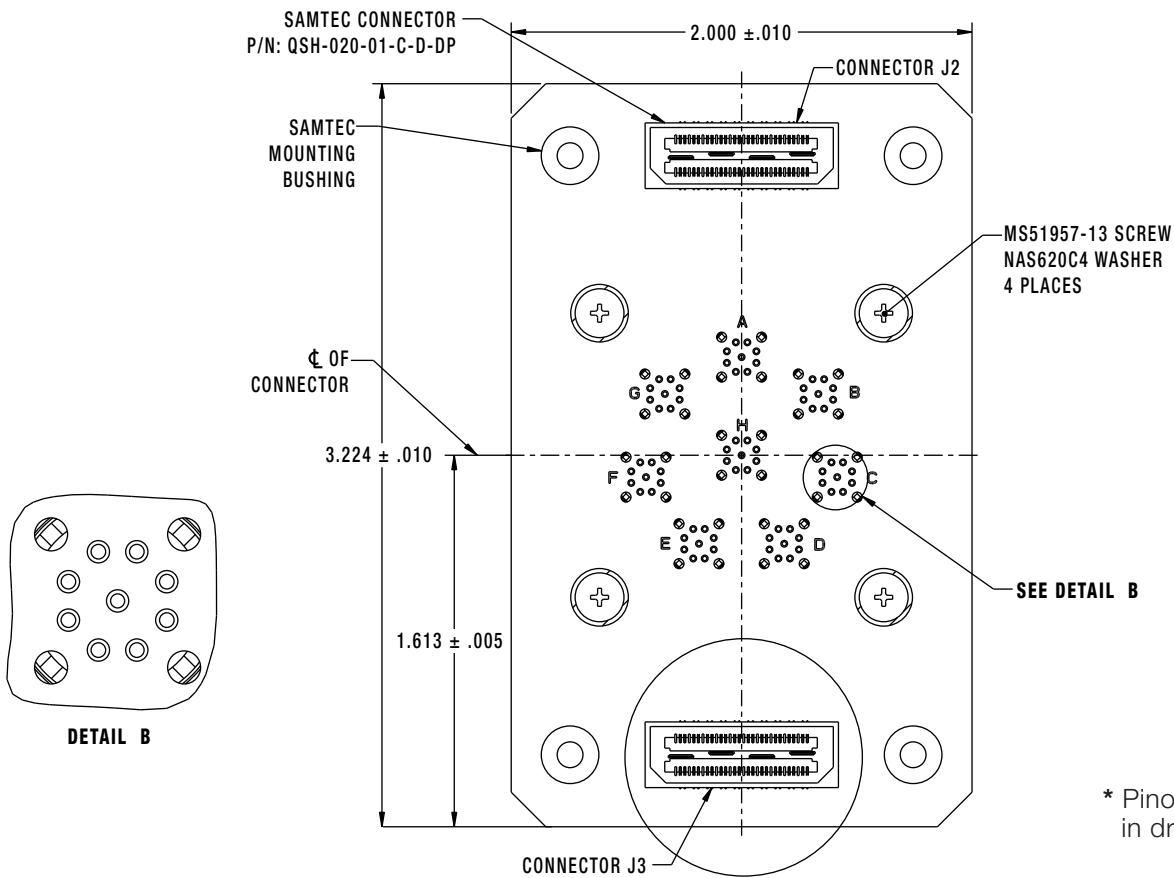
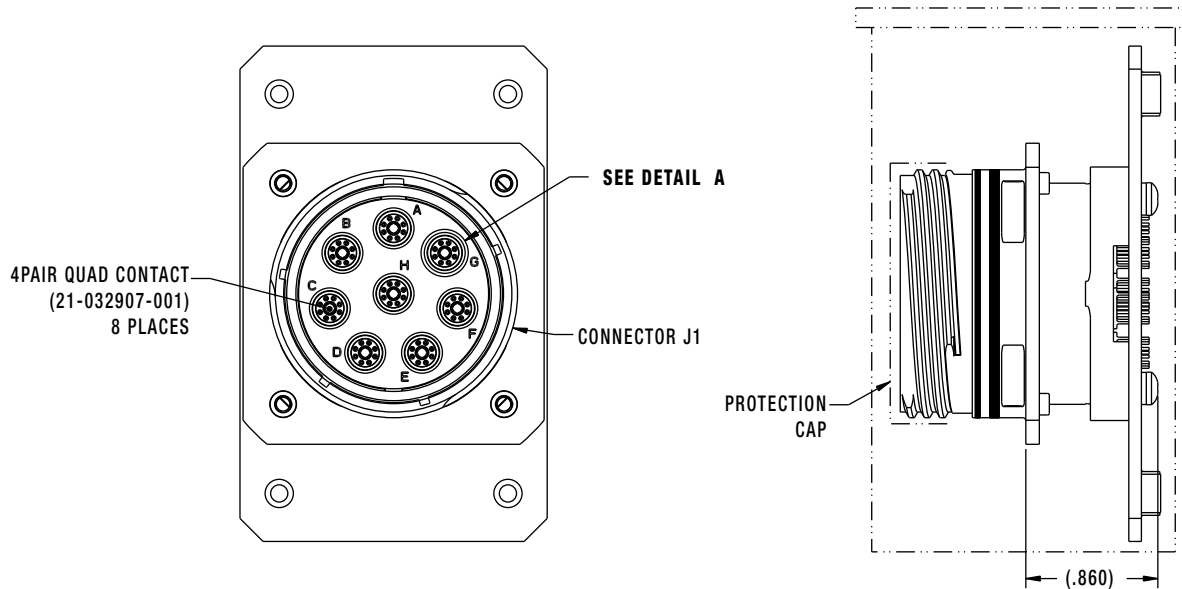

COMPLIMENTARY PRODUCT:

Octonet Contacts



Description :

Superior Ethernet contact system for MIL-DTL-38999, Series III. Eight strategically spaced inner contacts form four 100 Ohm matched impedance differential pairs.

Features and Benefits :

- Available in size 8 crimp termination style
- Also available in PC Tails
- Can be installed in existing size 8 Quadrx cavities
- Meets performance specifications of CAT-6A cable
- 10G Ethernet compliant
- Overall higher bandwidth than standard CAT5E Quadrx-supports up to 4.0 Gbps per pair
- Enhanced crosstalk performance (compared to standard Quadrx)
- Supports wire ranges 26 to 24 gauge
- Requires modification of MIL-DTL-38999 connector to accommodate keyed contacts
- Operating Temp -65°C to 175°C
- Easy drop-in replacement to installed connectors no need to redesign
- Self removing contact feature - no extra contact extraction tool needed (24 Gauge only)

Part Numbers :

Pin	Socket	*Cable	AWG
21-032904-001	21-032905-001	Thermax: MX10G-24HP	24
21-032904-011	21-032905-011	W.L.Gore: RCN8966-24	
21-032904-021	21-032905-021	PIC E6A3824, Harbour E10024065, E10024064	
21-032904-031	21-032905-031	W.L.Gore: GSC-03-840430-01	
21-032904-041	21-032905-041	Axon P542810	
21-032904-051	21-032905-051	PIC E6A6826	
21-032904-061	21-032905-061	Thermax MX10G-24FLX4	
PCB Pin	PCB Socket	L Dimension + or - 15	
21-032906-001	21-032907-001	Pin .884 / Socket 1.024	
21-032906-011	21-032907-011	.884	
21-032906-021	21-032907-021	.884	
21-032906-031	21-032907-031	.950	
21-032906-041	21-032907-041	.859	
21-032906-051	21-032907-051	.518	
21-032906-061	21-032907-061	.788	

* Not limited to cables shown

COMPLIMENTARY PRODUCTS:

Internal Fiber Cable: CF-020010-016

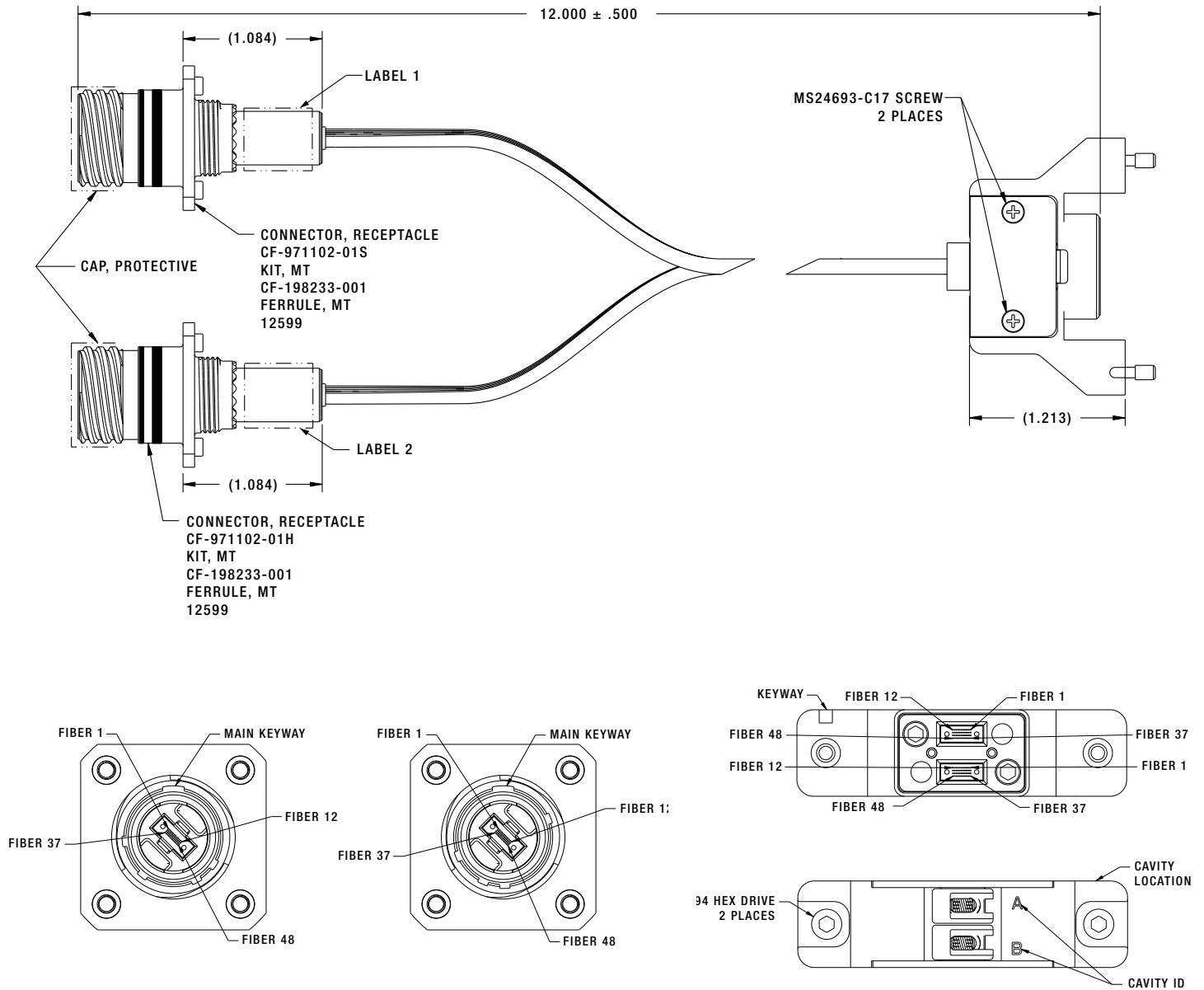

* Pinout data available in drawings by request

COMPLIMENTARY PRODUCTS:

External Fiber Cable: CF-901200-917

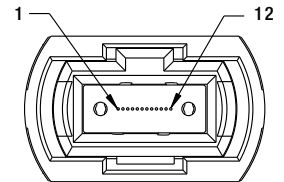
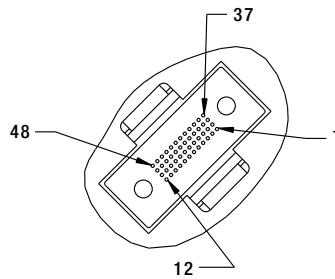
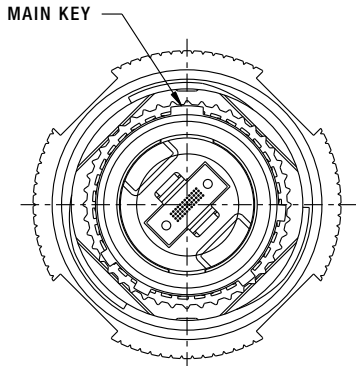
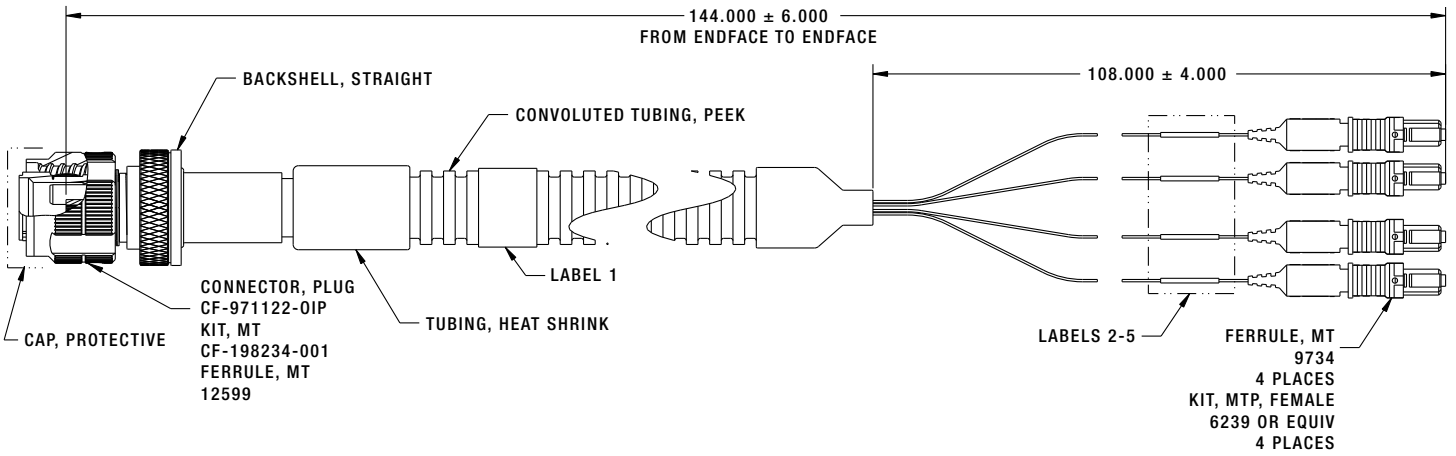

* Pinout data available
in drawings by request

COMPLIMENTARY PRODUCTS:

Test and De-bug RJ45 Adapter :

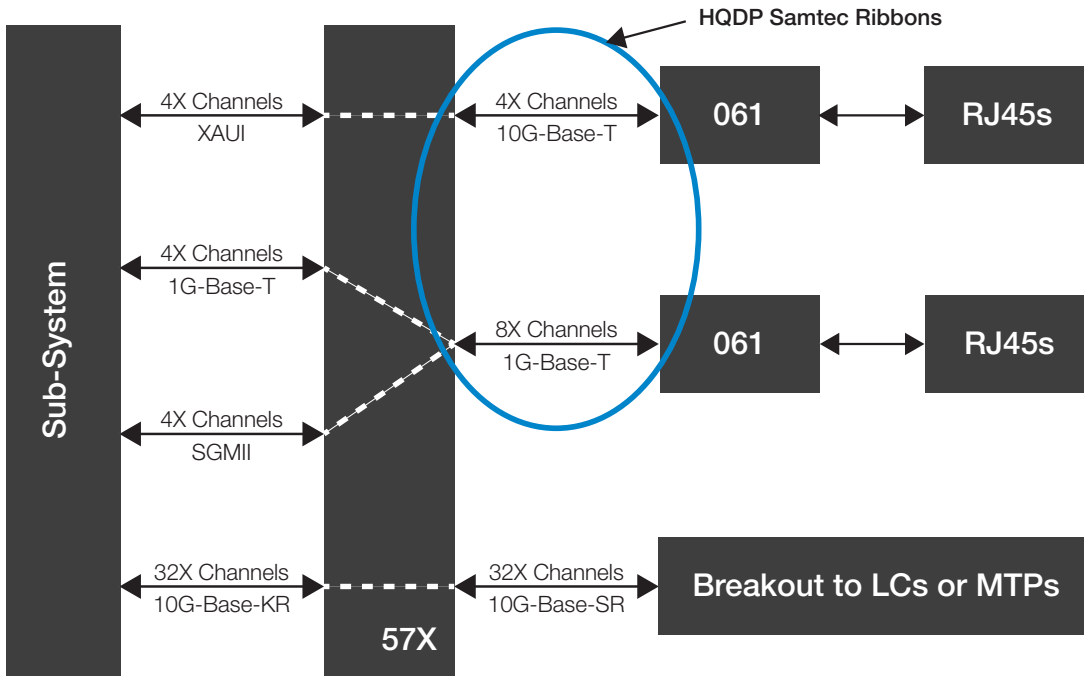

CF-980062-061 1G-Base-T and 10G-Base-T :

