

SERIES: CFM-80BG | **DESCRIPTION:** DC AXIAL FAN

FEATURES

- dual ball bearing system
- 80 x 80 mm frame
- multiple speed options
- PWM/tachometer wires available



MODEL

| | input voltage | | input current ¹ | input power ¹ | rated speed ¹ | airflow ² | static pressure ³ | noise ⁴ |
|--------------------|---------------|-------------|----------------------------|--------------------------|--------------------------|----------------------|------------------------------|--------------------|
| | rated [Vdc] | range [Vdc] | max [A] | max [W] | typ [RPM±10%] | [CFM] | [inch H ₂ O] | typ [dBA] |
| CFM-8025BG-140-396 | 12 | 10.8~13.2 | 0.27 | 3.24 | 4,000 | 41.40 | 0.27 | 39.6 |
| CFM-8025BG-150-444 | 12 | 10.8~13.2 | 0.35 | 4.20 | 5,000 | 51.74 | 0.43 | 44.5 |
| CFM-8025BG-160-484 | 12 | 10.8~13.2 | 0.56 | 6.72 | 6,000 | 62.09 | 0.61 | 48.4 |
| CFM-8025BG-170-517 | 12 | 10.8~13.2 | 0.75 | 9.00 | 7,000 | 72.44 | 0.84 | 51.8 |
| CFM-8025BG-180-546 | 12 | 10.8~13.2 | 1.10 | 13.20 | 8,000 | 82.79 | 1.09 | 54.7 |
| CFM-8025BG-190-572 | 12 | 10.8~13.2 | 1.52 | 18.24 | 9,000 | 93.14 | 1.38 | 57.3 |
| CFM-8025BG-240-396 | 24 | 21.6~26.4 | 0.15 | 3.60 | 4,000 | 41.40 | 0.27 | 39.6 |
| CFM-8025BG-250-444 | 24 | 21.6~26.4 | 0.20 | 4.80 | 5,000 | 51.74 | 0.43 | 44.5 |
| CFM-8025BG-260-484 | 24 | 21.6~26.4 | 0.30 | 7.20 | 6,000 | 62.09 | 0.61 | 48.4 |
| CFM-8025BG-270-517 | 24 | 21.6~26.4 | 0.56 | 13.44 | 7,000 | 72.44 | 0.84 | 51.8 |
| CFM-8025BG-280-546 | 24 | 21.6~26.4 | 0.55 | 13.20 | 8,000 | 82.79 | 1.09 | 54.7 |
| CFM-8025BG-290-572 | 24 | 21.6~26.4 | 0.76 | 18.24 | 9,000 | 93.14 | 1.38 | 57.3 |

- Notes:
1. At rated voltage, after 3 minutes.
 2. At rated voltage, room temperature, 65% humidity, 0 inch H₂O static pressure.
 3. At rated voltage, 0 CFM airflow.
 4. Measured in an anechoic chamber as per ISO3745/GB4214-84 at rated voltage, with background noise 20±2 dBA at 1 m from the fan intake.
 5. All specifications are measured at 25°C, 65% relative humidity unless otherwise specified.

PART NUMBER KEY

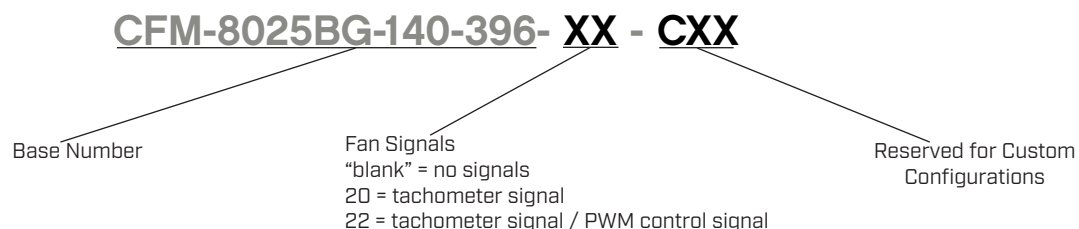

INPUT

| parameter | conditions/description | min | typ | max | units |
|--------------------------------------|-------------------------------|------|------|------|-------|
| operating input voltage ⁶ | 12 Vdc input models | 10.8 | 12 | 13.2 | Vdc |
| | 24 Vdc input models | 21.6 | 24 | 26.4 | Vdc |
| starting voltage | CFM-8025BG-190-572 models | | 8.0 | | Vdc |
| | all other 12 Vdc input models | | 7.0 | | Vdc |
| | 24 Vdc input models | | 14.0 | | Vdc |

Note: 6. See Model section on page 1 for specific input voltage ranges.

PERFORMANCE⁷

| parameter | conditions/description | min | typ | max | units |
|-----------------|--|-------|-----|-------|-----------------------|
| rated speed | at rated voltage, 25°C, after 3 minutes | 4,000 | | 9,000 | RPM |
| air flow | at 0 inch H ₂ O, see performance curves | 41.40 | | 93.14 | CFM |
| static pressure | at 0 CFM, see performance curves | 0.27 | | 1.38 | inch H ₂ O |
| noise | at 1 m, rated speed | 39.6 | | 57.3 | dBA |

Note: 7. See Model section on page 1 for specific values.

PROTECTIONS / FEATURES⁸

| parameter | conditions/description | min | typ | max | units |
|---------------------|-----------------------------------|-----|-----|-----|-------|
| auto restart | on all models | | | | |
| polarity protection | on all models | | | | |
| soft start | on all models | | | | |
| tachometer signal | available on "20" and "22" models | | | | |
| PWM control signal | available on "22" models | | | | |

Notes: 8. See Application Notes for details.

SAFETY & COMPLIANCE

| parameter | conditions/description | min | typ | max | units |
|-----------------------|---|-----|--------|-----|-------|
| insulation resistance | at 500 Vdc between frame and positive terminal | 10 | | | MΩ |
| dielectric strength | at 500 Vac, 60 Hz, 1 minute between housing and positive terminal | | | 5 | mA |
| safety approvals | UL/cUL 507, TUV [EN/IEC 62368-1:2020+A11] | | | | |
| EMI/EMC | EN 55032:2015, EN 55035:2017 | | | | |
| life expectancy | at 40°C, 65% RH, 90% confidence level | | 70,000 | | hours |
| RoHS | yes | | | | |

ENVIRONMENTAL

| parameter | conditions/description | min | typ | max | units |
|-----------------------|------------------------|-----|-----|-----|-------|
| operating temperature | | -10 | | 70 | °C |
| storage temperature | | -40 | | 75 | °C |
| operating humidity | non-condensing | 35 | | 85 | % |
| storage humidity | non-condensing | 35 | | 85 | % |

PERFORMANCE CURVES

CFM-8025BG-140-396

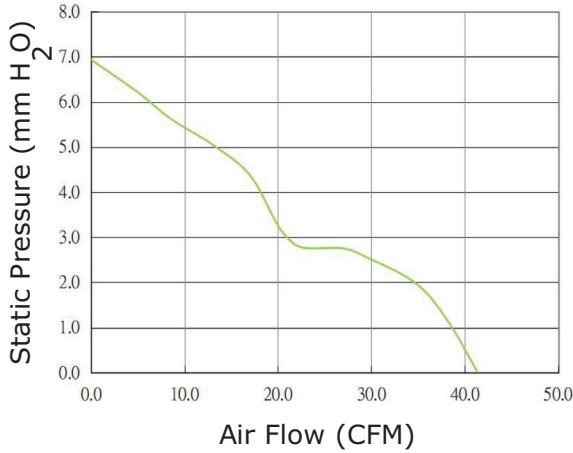

CFM-8025BG-150-444

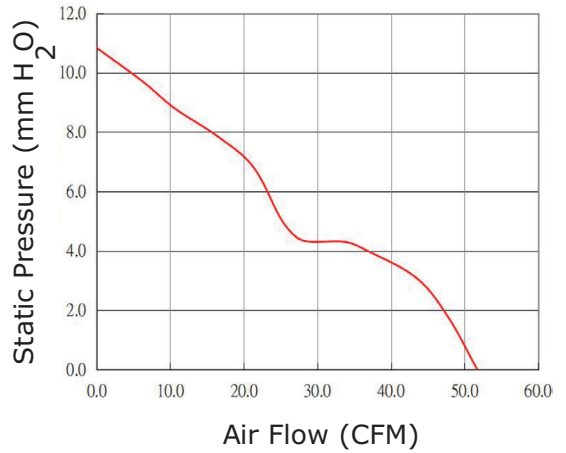

CFM-8025BG-160-484

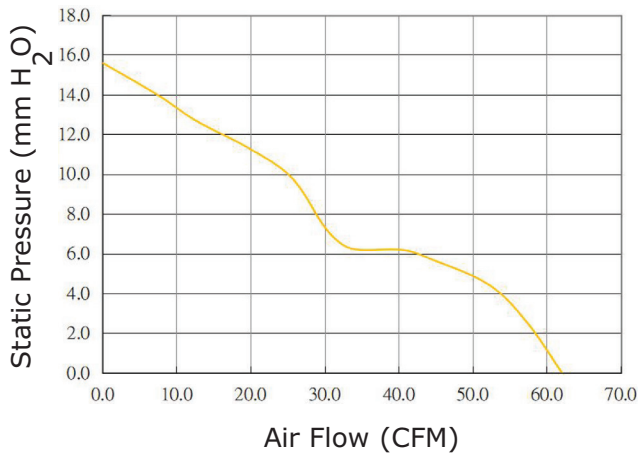

CFM-8025BG-170-517

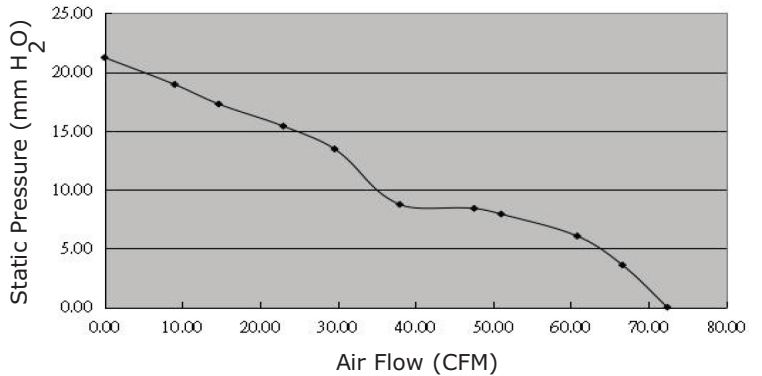

CFM-8025BG-180-546

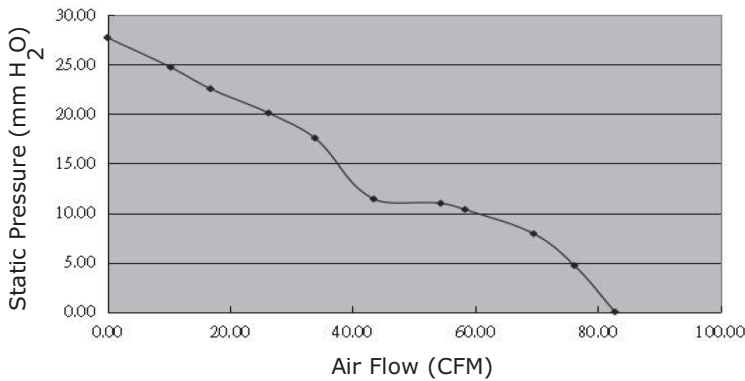

CFM-8025BG-190-572

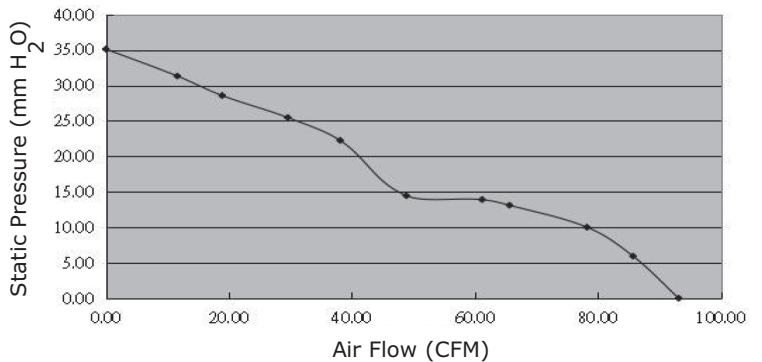

PERFORMANCE CURVES (CONTINUED)

CFM-8025BG-240-396

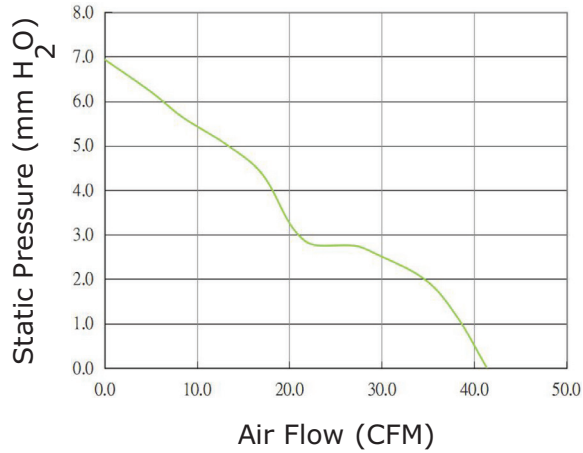

CFM-8025BG-250-444

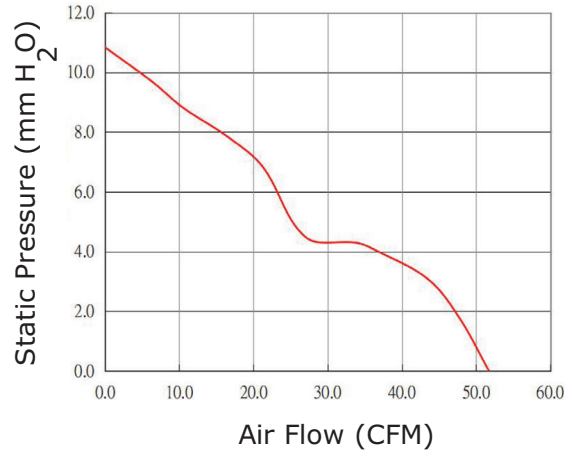

CFM-8025BG-260-484

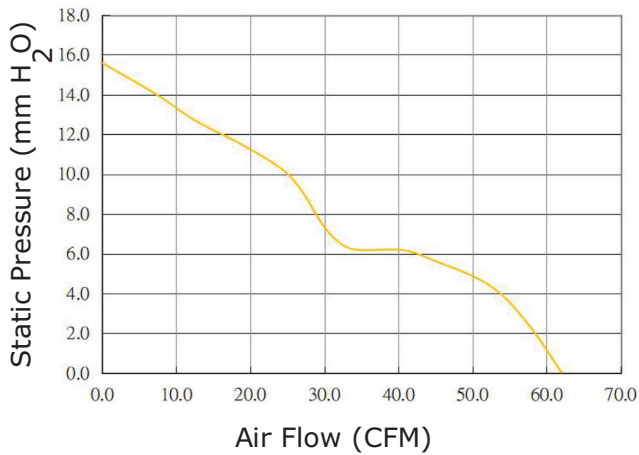

CFM-8025BG-270-517

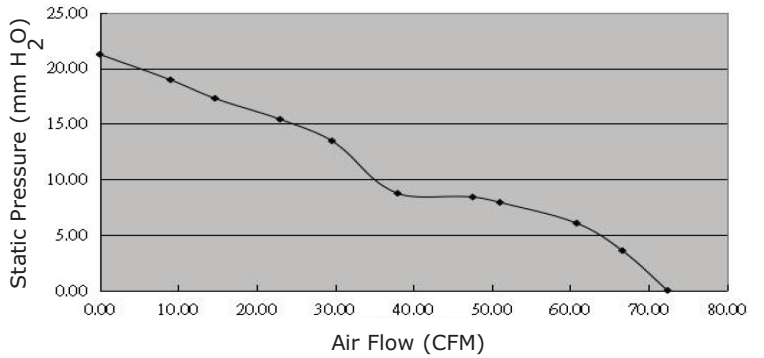

CFM-8025BG-280-546

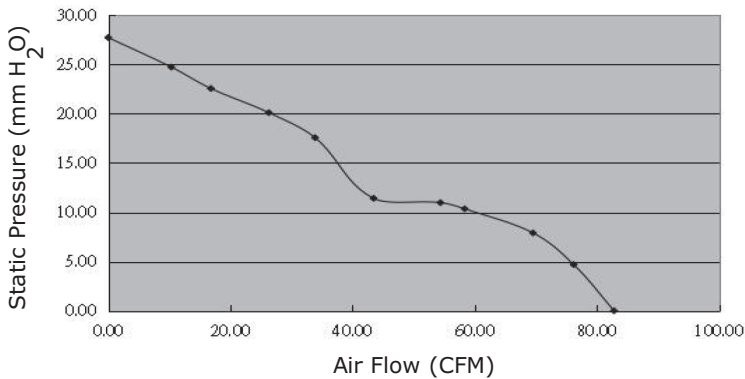

CFM-8025BG-290-572

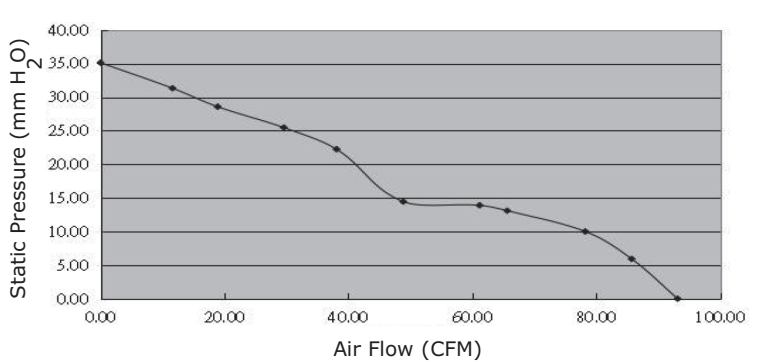

MECHANICAL

| parameter | conditions/description | min | typ | max | units |
|-----------------------|--|-----|-------|-----|-------|
| motor | 4 pole DC brushless | | | | |
| bearing system | dual ball bearing | | | | |
| direction of rotation | counter-clockwise viewed from front of fan blade | | | | |
| dimensions | 80 x 80 x 25.4 | | | | mm |
| material | PBT [UL94V-0] | | | | |
| weight | CFM-8025BG-270-517 | | 105.2 | | g |
| | CFM-8025BG-180-546 | | 104.8 | | g |
| | CFM-8025BG-190-572 | | 112.6 | | g |
| | CFM-8025BG-280-546 | | 104.8 | | g |
| | CFM-8025BG-290-572 | | 109.6 | | g |
| | all other models | | 105.5 | | g |

MECHANICAL DRAWING

units: mm

2 wire versions (+Vin & -Vin): UL 1430, 24 AWG
 3 wire versions (+Vin, -Vin, & tach): UL 1430, 24 AWG
 4 wire versions (+Vin, -Vin, tach, & PWM): UL 1430, 26 AWG

| MOUNTING SCREW (Pan Head) | | | |
|---------------------------|------|------------------|------------|
| Screw Type | Size | Standard | Torque |
| Machine Screw | M4 | JIS B1111-1974 | 7.5 kgf-cm |
| Self-tapping Screw | M5 | JIS B1122 Type 2 | 7.5 kgf-cm |

| WIRE CONNECTIONS | |
|---------------------|-------------|
| Wire Color | Function |
| Red | +Vin |
| Black | -Vin |
| Yellow ⁹ | Tach Signal |
| Blue ⁹ | PWM |

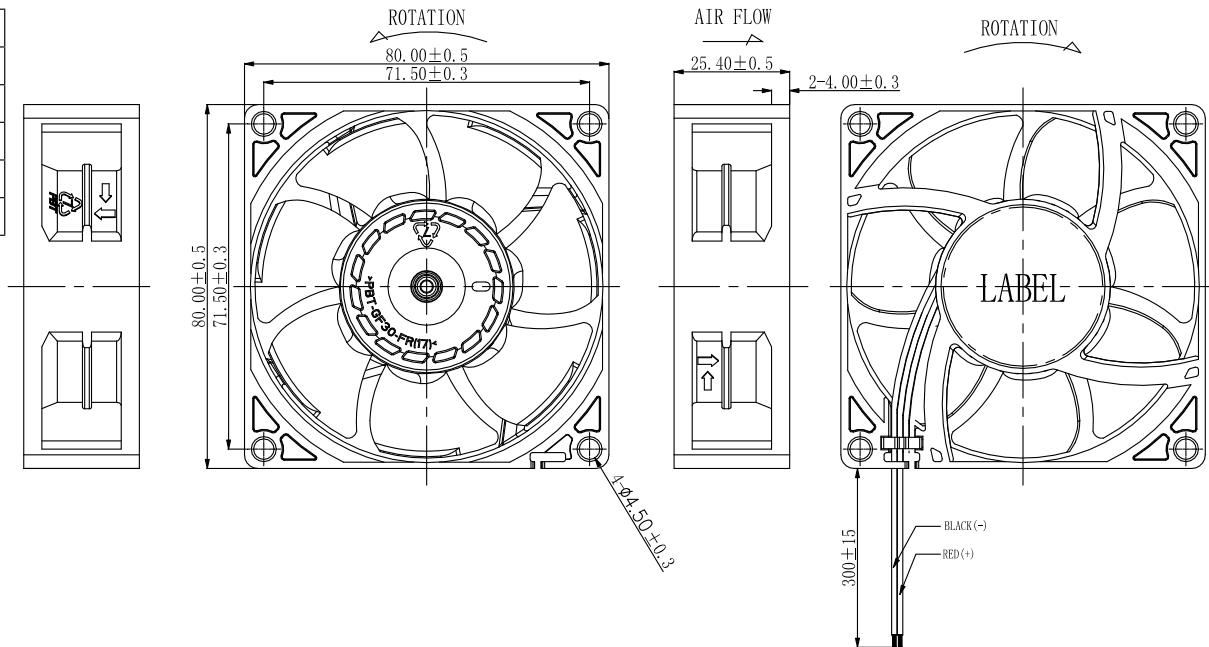

Notes: ⁹ Wires only present on versions with output signals.

APPLICATION NOTES

Auto Restart Protection

When the fan motor is locked by an external force, the device will temporarily turn off electrical power to the motor and restart automatically when the locked rotor condition is released.

Polarity Protection

Able to withstand 10 minutes of reverse polarity connection between the positive and negative wires without causing damage.

Tachometer Signal (Yellow Wire)

The tachometer signal is for detecting the rotational speed of the fan motor. The output will be a square wave when fan is operating and V_{FG} or V_{CE} depending on the locked rotor position when fan motor is locked (See Figures 1~2 below).

Figure 1: Tachometer Output Circuit

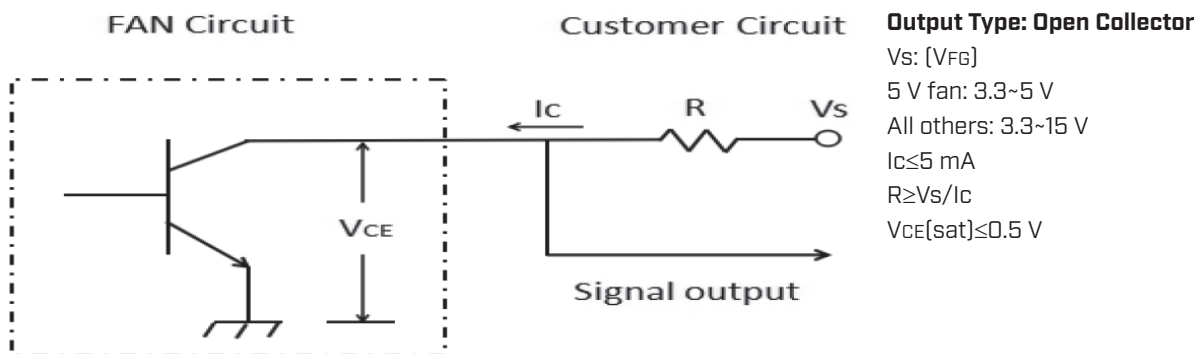
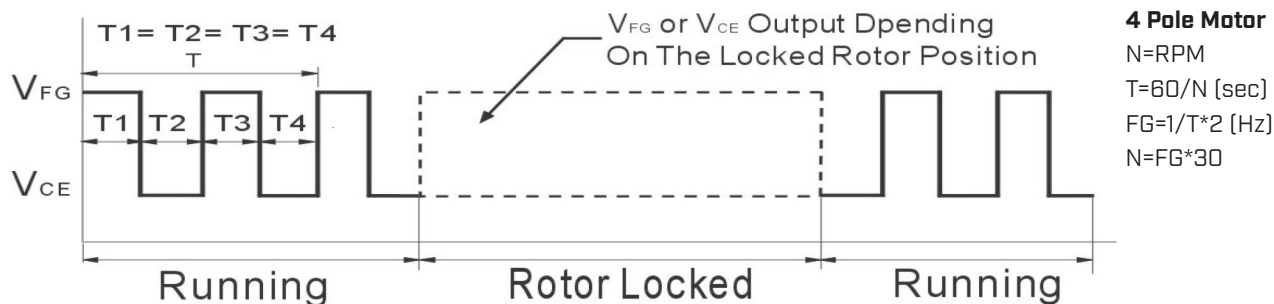

Figure 2: Tachometer Output Waveform



PWM Signal (Blue Wire)

This wire is for speed control of the fan motor using a PWM input signal from the customer circuit (See Figure 3 below).

Figure 3: PWM Input Signal

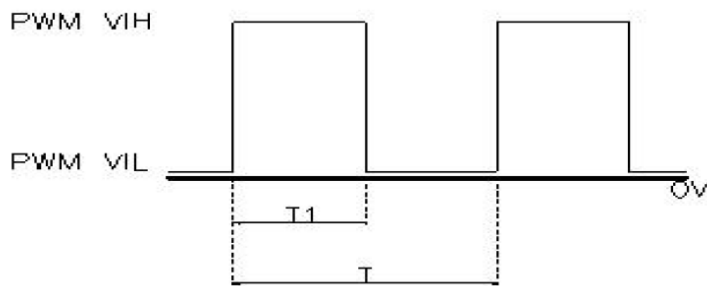

PWM Duty Cycle [%] = $T1/T \times 100\%$
 PWM Frequency Range: 20~30 kHz
 PWM VIH = 2.8~5.5 V
 PWM VIL = 0~0.6 V

Soft Start

When the fan power is on, the current will increase slowly (~15 seconds) until the fan reaches the rated speed.