

**SERIES:** CFM-80BG | **DESCRIPTION:** DC AXIAL FAN

**FEATURES**

- dual ball bearing system
- 80 x 80 mm frame
- multiple speed options
- PWM/tachometer wires available

**MODEL**

	input voltage		input current <sup>1</sup>	input power <sup>1</sup>	rated speed <sup>1</sup>	airflow <sup>2</sup>	static pressure <sup>3</sup>	noise <sup>4</sup>
	rated [Vdc]	range [Vdc]	max [A]	max [W]	typ [RPM±10%]	[CFM]	[inch H <sub>2</sub> O]	typ [dBA]
CFM-8025BG-140-396	12	10.8~13.2	0.27	3.24	4,000	41.40	0.27	39.6
CFM-8025BG-150-444	12	10.8~13.2	0.35	4.20	5,000	51.74	0.43	44.5
CFM-8025BG-160-484	12	10.8~13.2	0.56	6.72	6,000	62.09	0.61	48.4
CFM-8025BG-170-517	12	10.8~13.2	0.75	9.00	7,000	72.44	0.84	51.8
CFM-8025BG-180-546	12	10.8~13.2	1.10	13.20	8,000	82.79	1.09	54.7
CFM-8025BG-190-572	12	10.8~13.2	1.52	18.24	9,000	93.14	1.38	57.3
CFM-8025BG-240-396	24	21.6~26.4	0.15	3.60	4,000	41.40	0.27	39.6
CFM-8025BG-250-444	24	21.6~26.4	0.20	4.80	5,000	51.74	0.43	44.5
CFM-8025BG-260-484	24	21.6~26.4	0.30	7.20	6,000	62.09	0.61	48.4
CFM-8025BG-270-517	24	21.6~26.4	0.56	13.44	7,000	72.44	0.84	51.8
CFM-8025BG-280-546	24	21.6~26.4	0.55	13.20	8,000	82.79	1.09	54.7
CFM-8025BG-290-572	24	21.6~26.4	0.76	18.24	9,000	93.14	1.38	57.3

- Notes:
1. At rated voltage, after 3 minutes.
  2. At rated voltage, room temperature, 65% humidity, 0 inch H<sub>2</sub>O static pressure.
  3. At rated voltage, 0 CFM airflow.
  4. Measured in an anechoic chamber as per ISO3745/GB4214-84 at rated voltage, with background noise 20±2 dBA at 1 m from the fan intake.
  5. All specifications are measured at 25°C, 65% relative humidity unless otherwise specified.

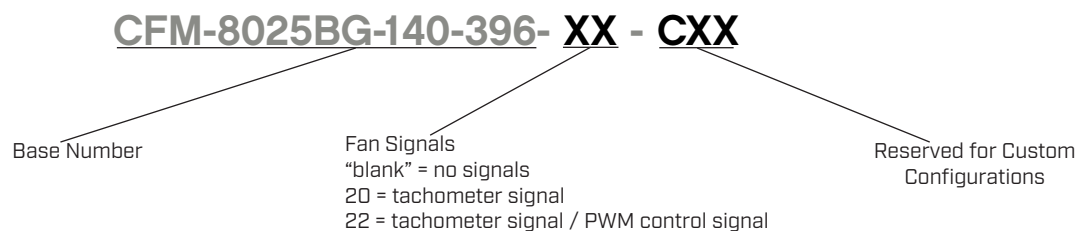
**PART NUMBER KEY**

## INPUT

parameter	conditions/description	min	typ	max	units
operating input voltage <sup>6</sup>	12 Vdc input models	10.8	12	13.2	Vdc
	24 Vdc input models	21.6	24	26.4	Vdc
starting voltage	CFM-8025BG-190-572 models		8.0		Vdc
	all other 12 Vdc input models		7.0		Vdc
	24 Vdc input models		14.0		Vdc

Note: 6. See Model section on page 1 for specific input voltage ranges.

## PERFORMANCE<sup>7</sup>

parameter	conditions/description	min	typ	max	units
rated speed	at rated voltage, 25°C, after 3 minutes	4,000		9,000	RPM
air flow	at 0 inch H <sub>2</sub> O, see performance curves	41.40		93.14	CFM
static pressure	at 0 CFM, see performance curves	0.27		1.38	inch H <sub>2</sub> O
noise	at 1 m, rated speed	39.6		57.3	dBA

Note: 7. See Model section on page 1 for specific values.

## PROTECTIONS / FEATURES<sup>8</sup>

parameter	conditions/description	min	typ	max	units
auto restart	on all models				
polarity protection	on all models				
soft start	on all models				
tachometer signal	available on "20" and "22" models				
PWM control signal	available on "22" models				

Notes: 8. See Application Notes for details.

## SAFETY & COMPLIANCE

parameter	conditions/description	min	typ	max	units
insulation resistance	at 500 Vdc between frame and positive terminal	10			MΩ
dielectric strength	at 500 Vac, 60 Hz, 1 minute between housing and positive terminal			5	mA
safety approvals	UL/cUL 507, TUV [EN/IEC 62368-1:2020+A11]				
EMI/EMC	EN 55032:2015, EN 55035:2017				
life expectancy	at 40°C, 65% RH, 90% confidence level		70,000		hours
RoHS	yes				

## ENVIRONMENTAL

parameter	conditions/description	min	typ	max	units
operating temperature		-10		70	°C
storage temperature		-40		75	°C
operating humidity	non-condensing	35		85	%
storage humidity	non-condensing	35		85	%

## PERFORMANCE CURVES

**CFM-8025BG-140-396**

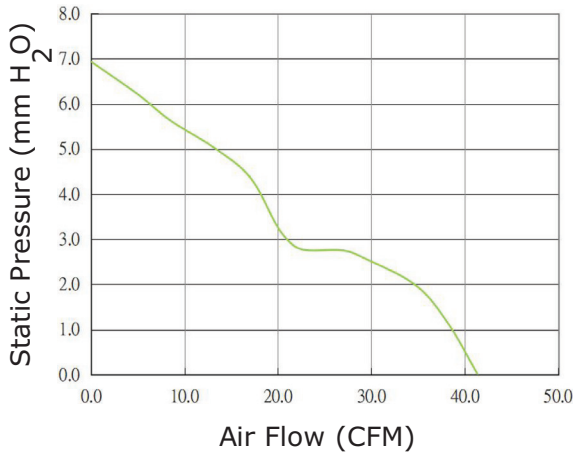

**CFM-8025BG-150-444**

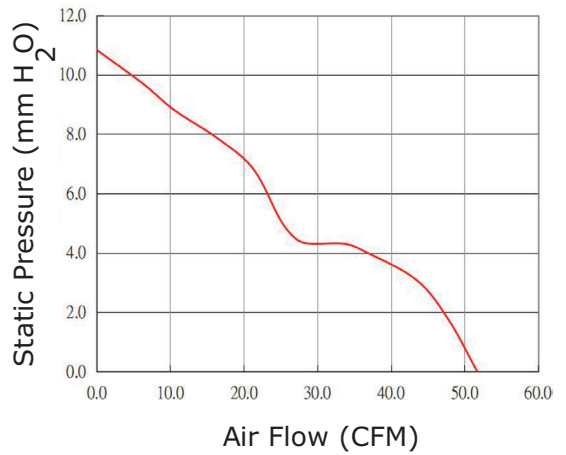

**CFM-8025BG-160-484**

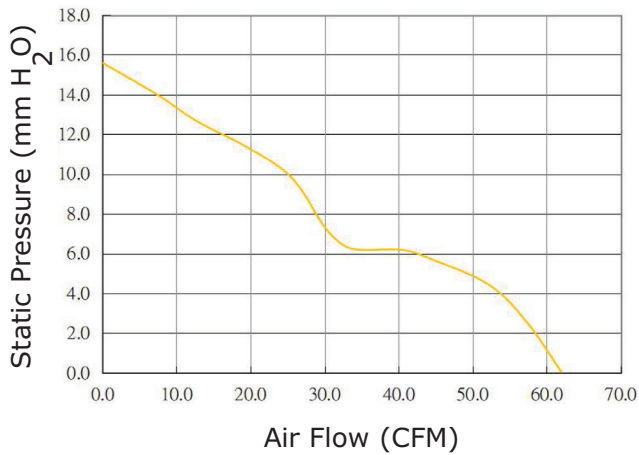

**CFM-8025BG-170-517**

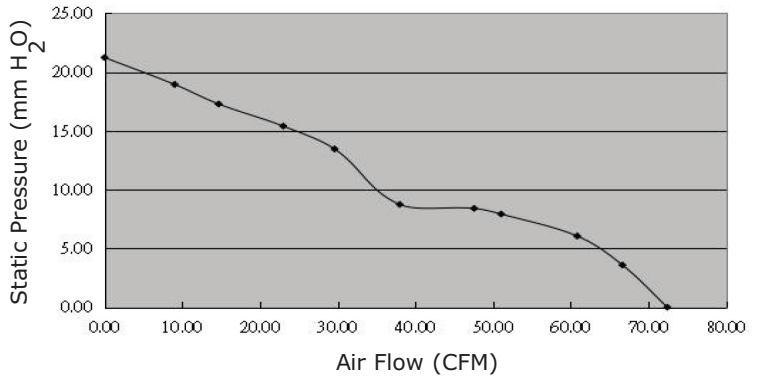

**CFM-8025BG-180-546**

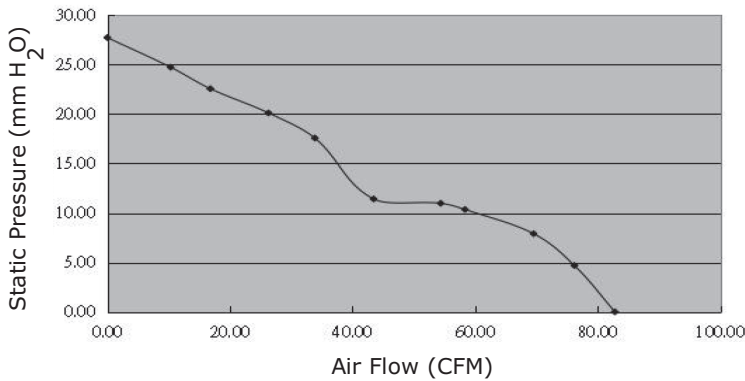

**CFM-8025BG-190-572**

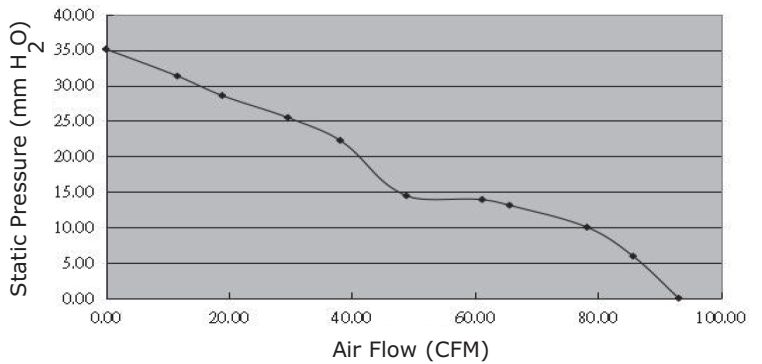

## PERFORMANCE CURVES (CONTINUED)

**CFM-8025BG-240-396**

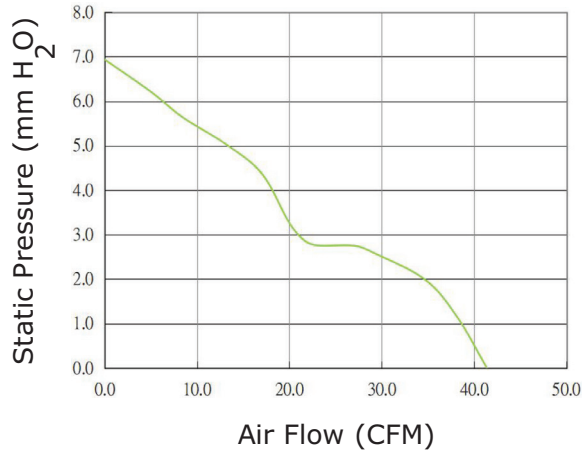

**CFM-8025BG-250-444**

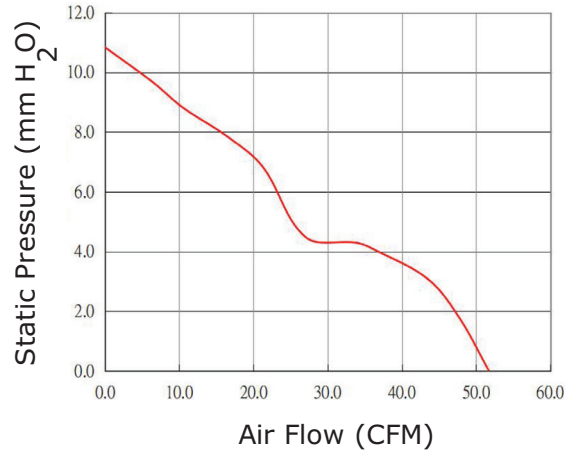

**CFM-8025BG-260-484**

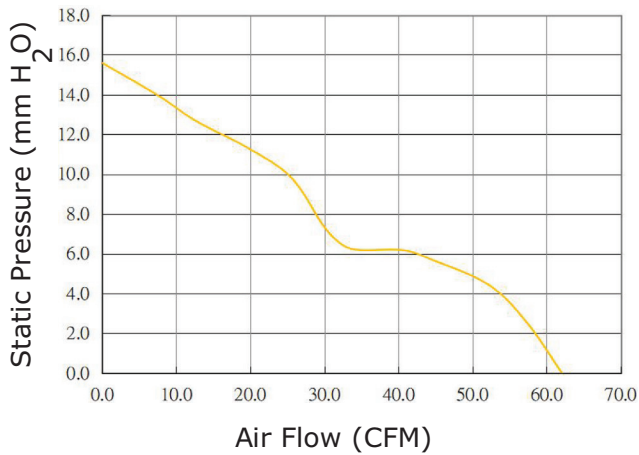

**CFM-8025BG-270-517**

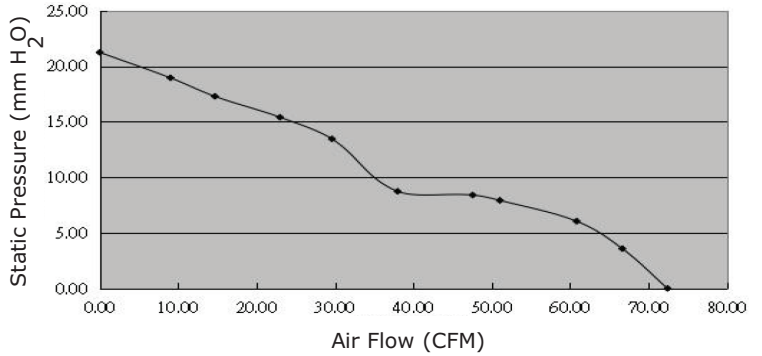

**CFM-8025BG-280-546**

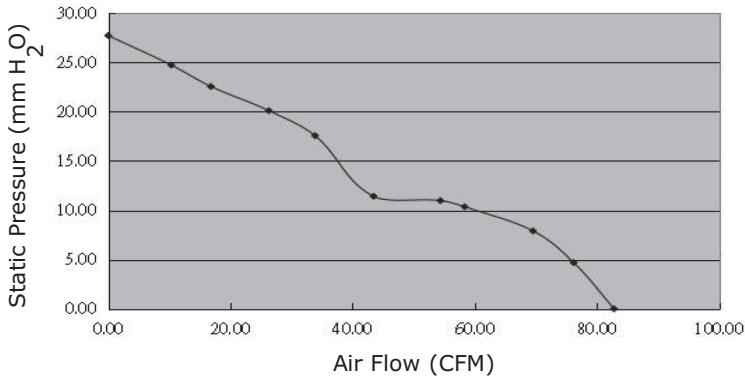

**CFM-8025BG-290-572**

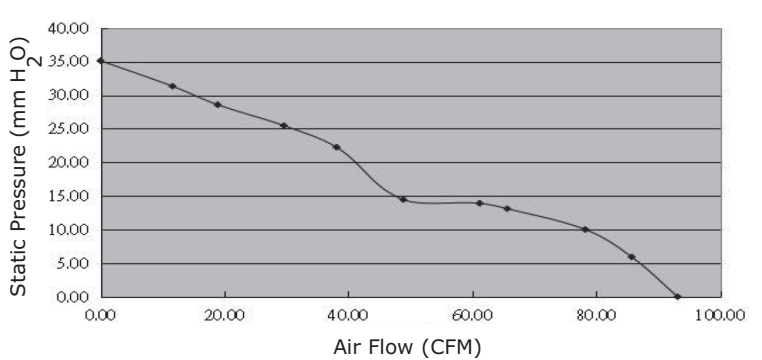

## MECHANICAL

parameter	conditions/description	min	typ	max	units
motor	4 pole DC brushless				
bearing system	dual ball bearing				
direction of rotation	counter-clockwise viewed from front of fan blade				
dimensions	80 x 80 x 25.4				mm
material	PBT [UL94V-0]				
weight	CFM-8025BG-270-517		105.2		g
	CFM-8025BG-180-546		104.8		g
	CFM-8025BG-190-572		112.6		g
	CFM-8025BG-280-546		104.8		g
	CFM-8025BG-290-572		109.6		g
	all other models		105.5		g

## MECHANICAL DRAWING

units: mm

2 wire versions (+Vin &amp; -Vin): UL 1430, 24 AWG

3 wire versions (+Vin, -Vin, &amp; tach): UL 1430, 24 AWG

4 wire versions (+Vin, -Vin, tach, &amp; PWM): UL 1430, 26 AWG

MOUNTING SCREW (Pan Head)			
Screw Type	Size	Standard	Torque
Machine Screw	M4	JIS B1111-1974	7.5 kgf-cm
Self-tapping Screw	M5	JIS B1122 Type 2	7.5 kgf-cm

WIRE CONNECTIONS	
Wire Color	Function
Red	+Vin
Black	-Vin
Yellow <sup>9</sup>	Tach Signal
Blue <sup>9</sup>	PWM

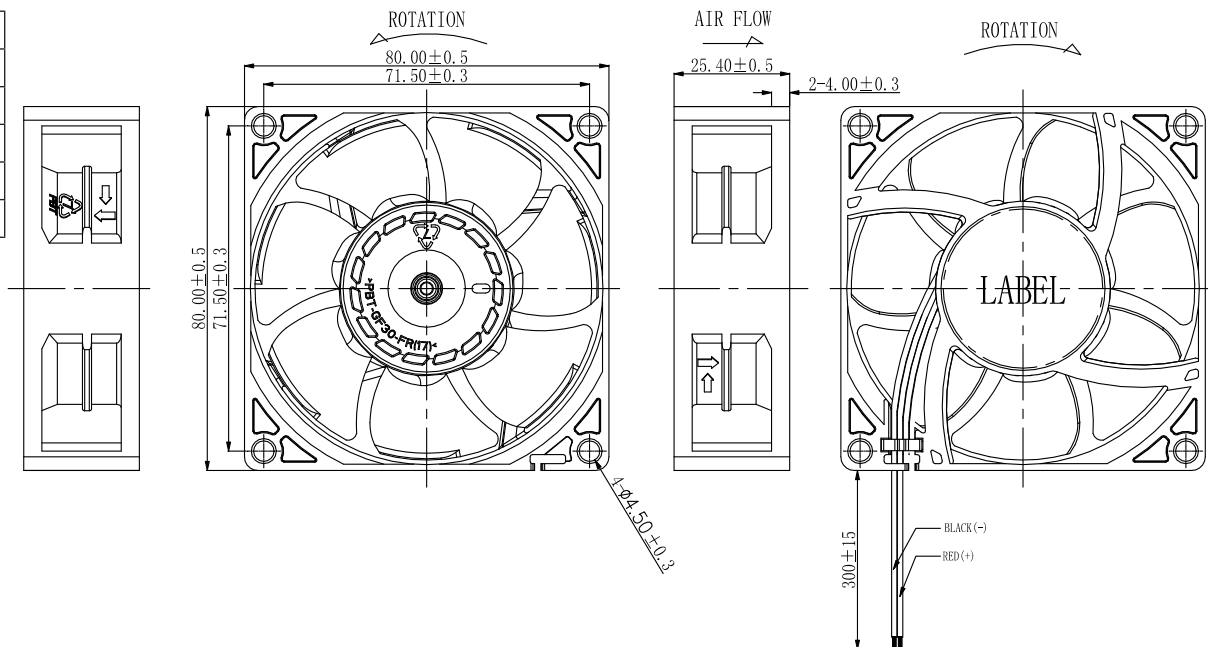
Notes: <sup>9</sup> Wires only present on versions with output signals.

## APPLICATION NOTES

### Auto Restart Protection

When the fan motor is locked by an external force, the device will temporarily turn off electrical power to the motor and restart automatically when the locked rotor condition is released.

### Polarity Protection

Able to withstand 10 minutes of reverse polarity connection between the positive and negative wires without causing damage.

### Tachometer Signal (Yellow Wire)

The tachometer signal is for detecting the rotational speed of the fan motor. The output will be a square wave when fan is operating and  $V_{FG}$  or  $V_{CE}$  depending on the locked rotor position when fan motor is locked (See Figures 1~2 below).

Figure 1: Tachometer Output Circuit

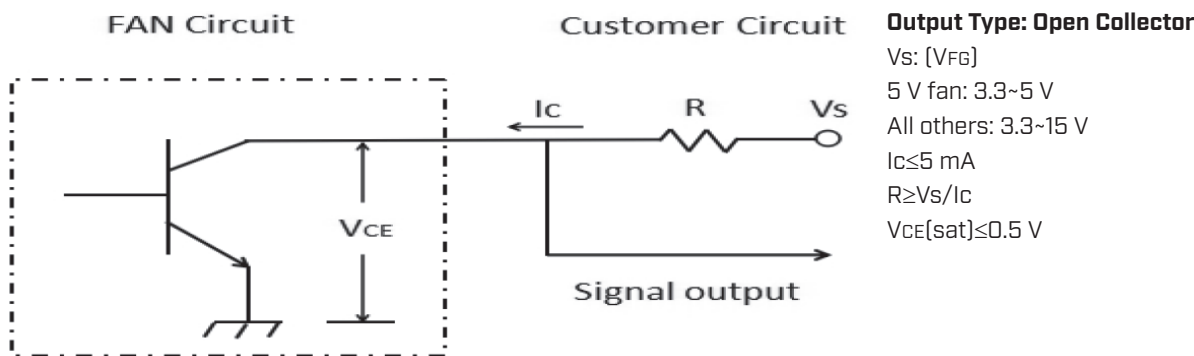
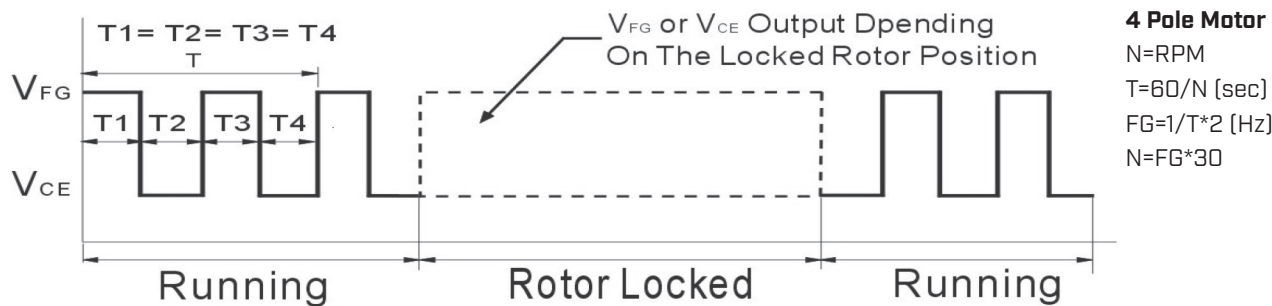

Figure 2: Tachometer Output Waveform



### PWM Signal (Blue Wire)

This wire is for speed control of the fan motor using a PWM input signal from the customer circuit (See Figure 3 below).

Figure 3: PWM Input Signal

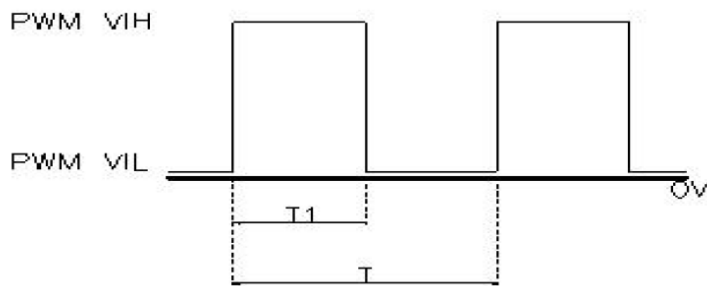

PWM Duty Cycle [%] =  $T1/T \times 100\%$   
 PWM Frequency Range: 20~30 kHz  
 PWM VIH = 2.8~5.5 V  
 PWM VIL = 0~0.6 V

### Soft Start

When the fan power is on, the current will increase slowly (~15 seconds) until the fan reaches the rated speed.