

# CFT-90-W Specialty White LED



## Table of Contents

|   |     |
|---|-----|
| General Considerations . . . . .              | 2   |
| Flux Binning Structure . . . . .              | 3   |
| Chromaticity Bins . . . . .                   | 4-5 |
| Ordering Information . . . . .                | 6   |
| Product Characteristics . . . . .             | 7   |
| Optical and Thermal Characteristics . . . . . | 8   |
| Mechanical Dimensions . . . . .               | 10  |
| Shipping Tray Outline . . . . .               | 11  |
| Packing and Shipping . . . . .                | 12  |
| History of Changes . . . . .                  | 13  |

## Features:

- Second generation monolithic 9 mm<sup>2</sup> specialty white LED delivers increased peak lumens and drive current over CBT-90-W
- High current operation: up to 27 A DC
- Over 5500 lumens at maximum drive current
- Available in 5700K, 6500K and 7800K (typ) color temperatures
- Window-less package design improves optical coupling efficiency
- Low thermal resistance chip-on-board packaging technology: 0.45 °C/W typical junction to back of core board.
- New common cathode chip technology delivers increased performance and simplifies system design
- Hot lumens specification, production tested at 22.5 A DC, 90 °C junction temperature
- Environmentally friendly, compliant with RoHS and REACH requirements

## Applications

- Fiber illumination including:
  - medical endoscopy
  - machine vision
  - microscopy and other instrumentation
- Inspection and industrial applications
- Stage and Entertainment spot lights, narrow beam projectors
- Architectural Lighting
- Off-road vehicle and truck projector lights
- Search Lights
- Beacons

## General Considerations

### Environmental Considerations:

As a leading provider of solid-state Lighting solutions, Luminus implements strict substance control policies to ensure all of its products are environmentally friendly. As with all Luminus LEDs, the CFT-90-W series are compliant with the Restriction of Hazardous Substances (RoHS) and REACH directives from the European Community.

### Product Testing:

Every CFT-90-W LED is fully production tested to ensure it meets the high quality standards customers have come to expect from Luminus products. Devices are tested and binned at a controlled 40°C heat sink temperature and with a 22.5 A DC current, corresponding to a nominal junction temperature of 90°C. As a result, the devices lumens and chromaticity are binned “hot” and their characteristics are close to in-system operating conditions. Current and temperature curves are provided in this document allowing users to predict the LED performance and characteristics under their own driving and thermal conditions.

### Reliability:

Luminus CFT-90-W LED series are required to pass a rigorous suite of environmental and mechanical stress tests, including mechanical shock, vibration, temperature cycling and humidity. These tests ensure that the devices deliver high performance and achieve reliable long term operation in demanding high power applications. Please contact Luminus for further information.

### Flux Binning Structure<sup>1,2</sup>

CFT-90-W LED series are production tested and binned at 22.5A DC, 40°C heat sink temperature (90°C nominal junction temperature).

Flux Bins<sup>3</sup>

| Flux Bin | Minumum Flux (lm) | Maximum Flux (lm) |
|----------|-------------------|-------------------|
| UA       | 3,680             | 3,955             |
| UB       | 3,955             | 4,230             |
| VA       | 4,230             | 4,545             |
| VB       | 4,545             | 4,860             |
| WA       | 4,860             | 5,225             |
| WB       | 5,225             | 5,590             |
| XA       | 5590              | 6011              |
| XB       | 6011              | 6430              |

Note 1: Luminus maintains a +/- 6% tolerance on flux measurements.

Note 2: Products are production tested then sorted and packed by bin.

Note 3: Individual bins are not orderable. Please refer to the Product Ordering information page for a list of orderable bin kits.

**Chromaticity Bins**

Refer to the next page for bin definitions

The following tables describe the four chromaticity points that bound each chromaticity bin.<sup>1</sup>

| Chromaticity Bins |       |       |
|-------------------|-------|-------|
| Bin Code          | x     | y     |
| A                 | 0.263 | 0.285 |
|                   | 0.272 | 0.296 |
|                   | 0.285 | 0.272 |
|                   | 0.278 | 0.264 |
| B                 | 0.272 | 0.296 |
|                   | 0.282 | 0.308 |
|                   | 0.293 | 0.281 |
|                   | 0.285 | 0.272 |
| C                 | 0.282 | 0.308 |
|                   | 0.286 | 0.313 |
|                   | 0.296 | 0.285 |
|                   | 0.293 | 0.281 |
| D                 | 0.286 | 0.313 |
|                   | 0.293 | 0.320 |
|                   | 0.300 | 0.298 |
|                   | 0.294 | 0.292 |
| DEL               | 0.294 | 0.292 |
|                   | 0.308 | 0.307 |
|                   | 0.309 | 0.302 |
|                   | 0.295 | 0.288 |
| DEH               | 0.285 | 0.317 |
|                   | 0.302 | 0.336 |
|                   | 0.303 | 0.331 |
|                   | 0.286 | 0.313 |
| E                 | 0.293 | 0.320 |
|                   | 0.303 | 0.331 |
|                   | 0.308 | 0.307 |
|                   | 0.300 | 0.298 |
| F                 | 0.303 | 0.331 |
|                   | 0.311 | 0.339 |
|                   | 0.314 | 0.318 |
|                   | 0.307 | 0.311 |
| FGH               | 0.302 | 0.336 |
|                   | 0.320 | 0.354 |
|                   | 0.321 | 0.348 |
|                   | 0.303 | 0.331 |

| Chromaticity Bins |       |       |
|-------------------|-------|-------|
| Bin Code          | x     | y     |
| FGL               | 0.307 | 0.311 |
|                   | 0.322 | 0.326 |
|                   | 0.323 | 0.315 |
|                   | 0.309 | 0.302 |
| G                 | 0.311 | 0.339 |
|                   | 0.321 | 0.348 |
|                   | 0.322 | 0.326 |
|                   | 0.314 | 0.318 |
| H                 | 0.321 | 0.346 |
|                   | 0.329 | 0.353 |
|                   | 0.329 | 0.330 |
|                   | 0.322 | 0.324 |
| HJL               | 0.322 | 0.324 |
|                   | 0.337 | 0.337 |
|                   | 0.336 | 0.325 |
|                   | 0.323 | 0.314 |
| HJH               | 0.320 | 0.352 |
|                   | 0.338 | 0.368 |
|                   | 0.338 | 0.361 |
|                   | 0.321 | 0.346 |
| J                 | 0.329 | 0.353 |
|                   | 0.338 | 0.361 |
|                   | 0.337 | 0.337 |
|                   | 0.329 | 0.330 |
| K                 | 0.338 | 0.361 |
|                   | 0.346 | 0.368 |
|                   | 0.344 | 0.342 |
|                   | 0.337 | 0.337 |
| KH                | 0.338 | 0.368 |
|                   | 0.346 | 0.375 |
|                   | 0.346 | 0.368 |
|                   | 0.338 | 0.361 |

**Note 1:** Based on production test conditions: 22.5 A DC, 90°C junction temperature.

**Note 2:** Chromaticity bin code A is defined but not offered in a bin kit.

**Ordering Information**
**CFT** — **<XX>** — **W<tc>** — **X11** — **<BinKit>**
**Part Numbering Nomenclature**

| Product Family  | LED Emission Area        | Color Code  | Package Configuration | Bin Kit  |
|---|--------------------------|---|-----------------------|--|
| C: Chip on board<br>F: Flat-top window-less package<br>T: Single monolithic emitter | 90 = 9.0 mm <sup>2</sup> | W = White<br>t : Color temperature<br>- D : Daylight<br>- C : Cool White<br>- S : Stage White<br>c: CRI<br>- S = Standard | Internal package code | Refer to ordering codes table in this document |

**Ordering Part Numbers**

| Color Point       | Code of Minimum Bin | Minimum Flux (lm) <sup>1,2</sup> | Chromaticity Bins <sup>1</sup> | Bin Kit | Ordering Part Number |
|-------------------|---------------------|----------------------------------|--------------------------------|---------|----------------------|
| WDS               | UA                  | 3,680                            | H, J, HJH, HJL, K, KH          | UA500   | CFT-90-WDS-X11-UA500 |
|                   |                     |                                  | H, J, HJH, HJL                 | UA501   | CFT-90-WDS-X11-UA501 |
|                   |                     |                                  | H, J                           | UA502   | CFT-90-WDS-X11-UA502 |
|                   | UB                  | 3,955                            | H, J, HJH, HJL, K, KH          | UB500   | CFT-90-WDS-X11-UB500 |
|                   |                     |                                  | H, J, HJH, HJL                 | UB501   | CFT-90-WDS-X11-UB501 |
|                   |                     |                                  | H, J                           | UB502   | CFT-90-WDS-X11-UB502 |
|                   | VA                  | 4230                             | H, J, HJH, HJL, K, KH          | VA500   | CFT-90-WDS-X11-VA500 |
|                   |                     |                                  | H, J, HJH, HJL                 | VA501   | CFT-90-WDS-X11-VA501 |
|                   | VB                  | 4545                             | H, J, HJH, HJL, K, KH          | VB500,  | CFT-90-WDS-X11-VB500 |
| WCS               | UA                  | 3,680                            | D, E, F, G, DEH, DEL, FGH, FGL | UA600   | CFT-90-WCS-X11-UA600 |
|                   |                     |                                  | F, G, FGH, FGL                 | UA601   | CFT-90-WCS-X11-UA601 |
|                   | UB                  | 3,955                            | D, E, F, G, DEH, DEL, FGH, FGL | UB600   | CFT-90-WCS-X11-UB600 |
|                   |                     |                                  | F, G, FGH, FGL                 | UB601   | CFT-90-WCS-X11-UB601 |
|                   | VA                  | 4230                             | D, E, F, G, DEH, DEL, FGH, FGL | VA600   | CFT-90-WCS-X11-VA600 |
|                   |                     |                                  | F, G, FGH, FGL                 | VA601   | CFT-90-WCS-X11-VA601 |
|                   | VB                  | 4545                             | D, E, F, G, DEH, DEL, FGH, FGL | VB600   | CFT-90-WCS-X11-VB600 |
|                   | WSS                 | UA                               | 3,680                          | B, C, D | UA900                |
| C, D, E, DEH, DEL |                     |                                  |                                | UA700   | CFT-90-WSS-X11-UA700 |
| D, E, DEH, DEL    |                     |                                  |                                | UA701   | CFT-90-WSS-X11-UA701 |
| UB                |                     | 3,955                            | B, C, D                        | UB900   | CFT-90-WSS-X11-UB900 |
|                   |                     |                                  | C, D, E, DEH, DEL              | UB700   | CFT-90-WSS-X11-UB700 |
|                   |                     |                                  | D, E, DEH, DEL                 | UB701   | CFT-90-WSS-X11-UB701 |
| VA                |                     | 4230                             | C, D, E, DEH, DEL              | VA700   | CFT-90-WSS-X11-VA700 |
|                   |                     |                                  | D, E, DEH, DEL                 | VA701   | CFT-90-WSS-X11-VA701 |
| VB                |                     | 4545                             | C, D, E, DEH, DEL              | VB700   | CFT-90-WSS-X11-VB700 |

Note 1: Based on production test conditions : 22.5 A DC, 90°C junction temperature.

Note 2: The minimum flux of each bin kit is determined by the minimum flux bin. Higher flux bins are eligible to ship against shown bin kits and part numbers.

## Product Characteristics and Ratings

### Product Characteristics

Unless specified otherwise, all characteristics are based on nominal  $T_j = 90^\circ\text{C}$ ,  $I_f = 22.5\text{ A DC}$ .

| Parameter                            | Symbol                |     | Value |       |       | Unit    |
|--------------------------------------|-----------------------|-----|-------|-------|-------|---------|
|                                      |                       |     | WSS   | WCS   | WDS   |         |
| Emitting Area Dimension <sup>1</sup> | $A_e$                 | typ | 3 x 3 | 3 x 3 | 3 x 3 | mm x mm |
| Luminous Flux                        | $\Phi_v$              | typ | 4750  | 4775  | 4800  | lumens  |
| Radiometric flux                     | $\Phi_e$              | typ | 15.1  | 15.4  | 15.7  | watts   |
| Viewing angle (50% of peak flux)     | $2 \varnothing_{1/2}$ | typ | 120   | 120   | 120   | degrees |
| Forward Voltage                      | $V_F$                 | min | 2.9   | 2.9   | 2.9   | V       |
|                                      |                       | typ | 3.5   | 3.5   | 3.5   | V       |
|                                      |                       | max | 4.2   | 4.2   | 4.2   | V       |
| Color Rendering Index                | CRI                   | typ | 70    | 70    | 65    |         |

Note 1: Please refer to mechanical drawing for dimensions and tolerancing.

### Absolute Maximum Ratings

| Parameter  | Symbol | Value      | Unit             |
|--|--------|------------|------------------|
| Maximum Current (CW) <sup>1</sup>                                    | $I_F$  | 27         | A                |
| Minimum Current (CW) <sup>2</sup>                                    | $I_F$  | 0.2        | A                |
| Maximum surge Current<br>( $t < 10\text{ ms}$ , Duty cycle $< 0.1$ ) | $I_S$  | 36         | A                |
| Maximum reverse Current <sup>3</sup>                                 | $I_R$  | N/A        | A                |
| Maximum Junction operating temperature <sup>4</sup>                  | $T_j$  | 150        | $^\circ\text{C}$ |
| Storage Temperature range  |        | -40 to 130 | $^\circ\text{C}$ |
| Operating Temperature range  |        | -40 to 85  | $^\circ\text{C}$ |

Note 1: Sustained operation at maximum current will result in shortened lifetime.

Note 2: Special design considerations must be observed for operation at low current density. Please contact Luminus for further information.

Note 3: Not designed for reverse current operation.

Note 4: Sustained operation at maximum operating  $T_j$  will result in shortened lifetime and may cause premature product failure.

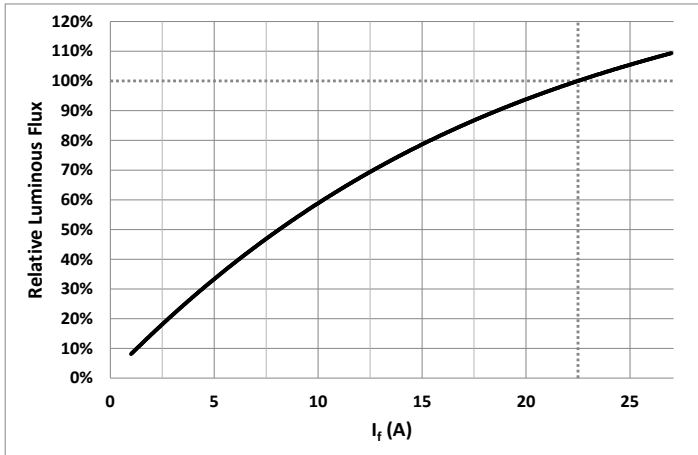
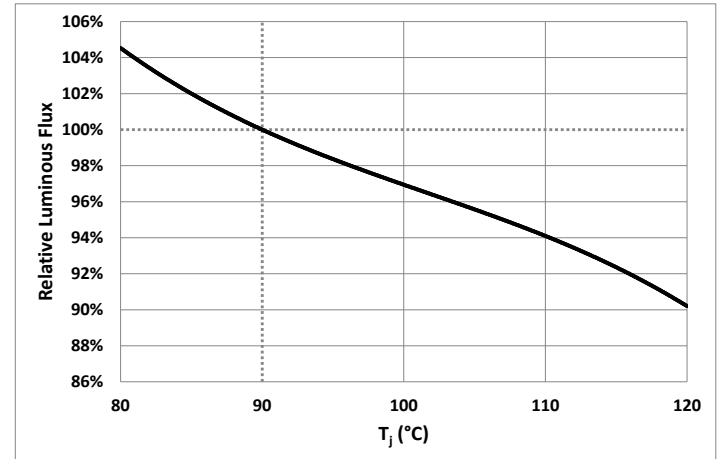
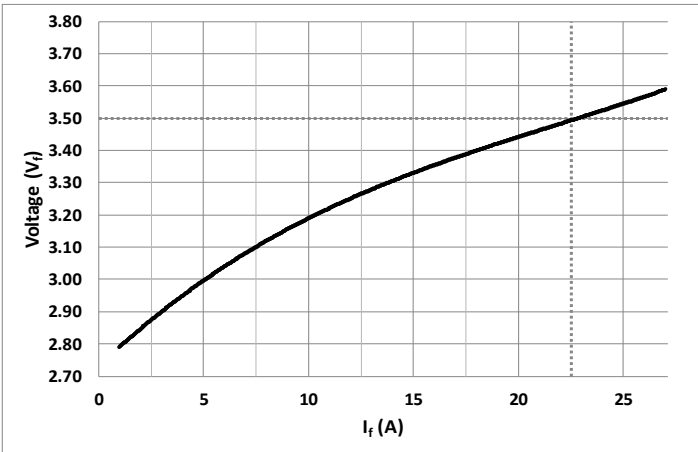
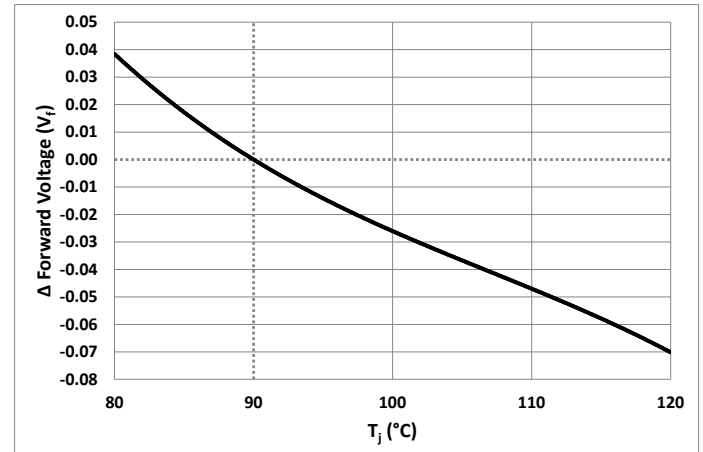
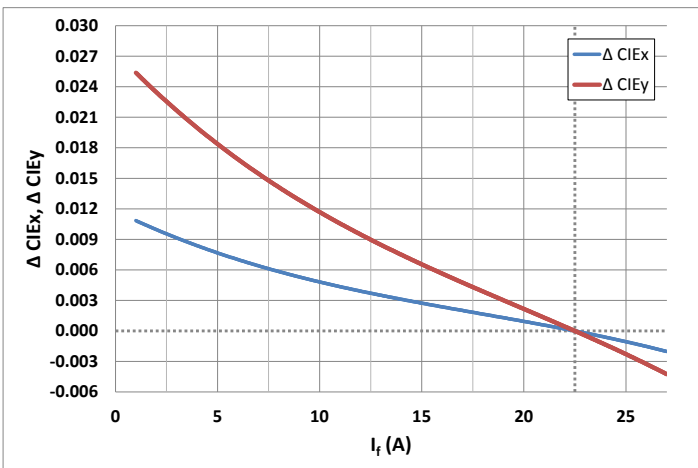
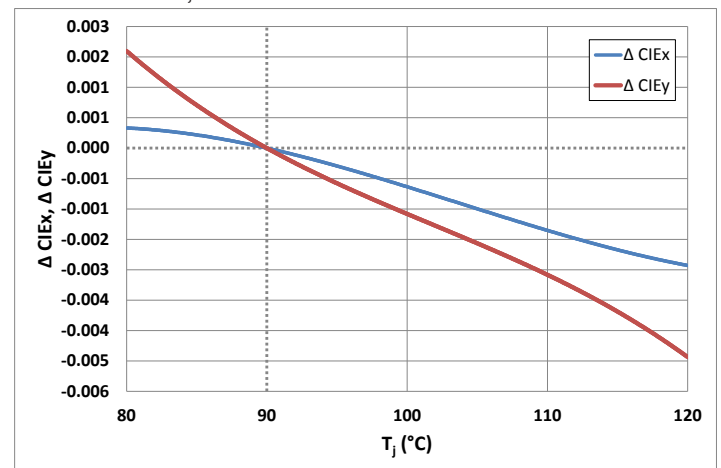
**Relative Luminous Flux vs.  $I_f$** 
 $\phi_v/\phi_v(22.5A), DC - T_{Heatsink} = 40^\circ C$ 

**Relative Luminous Flux vs.  $T_j$** 
 $\phi_v/\phi_v(90^\circ C) I_f = 22.5 A DC$ 

**Forward Voltage vs.  $I_f$** 
 $V_f = f(I_f), DC - T_{Heatsink} = 40^\circ C$ 

**Relative Forward Voltage vs.  $T_j$** 
 $\Delta V_f = V(T_j) - V(90^\circ C) I_f = 22.5 A DC$ 

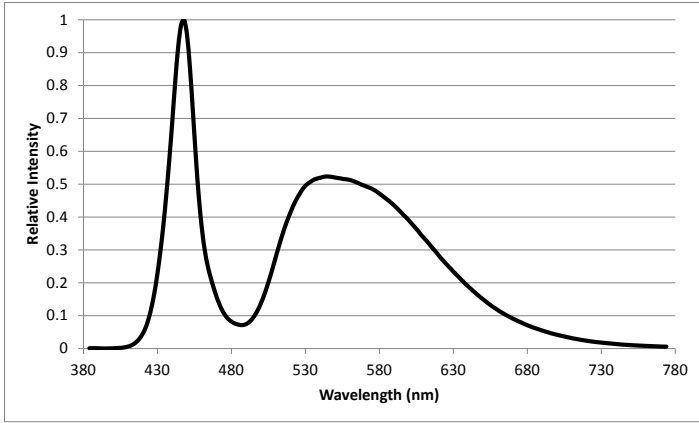
**Relative Chromaticity Shift vs.  $I_f$** 
 $\Delta CIE_{x,y} = CIE_{x,y}(I_f) - CIE_{x,y}(22.5A) - DC, Heatsink Temperature: 40^\circ C$ 

**Relative Chromaticity Shift vs.  $T_j$** 
 $\Delta CIE_{x,y} = CIE_{x,y}(T_j) - CIE_{x,y}(90^\circ C) I_f = 22.5 A DC$ 



### Optical and Thermal Characteristics

Typical Spectrum



Typical Angular Distribution

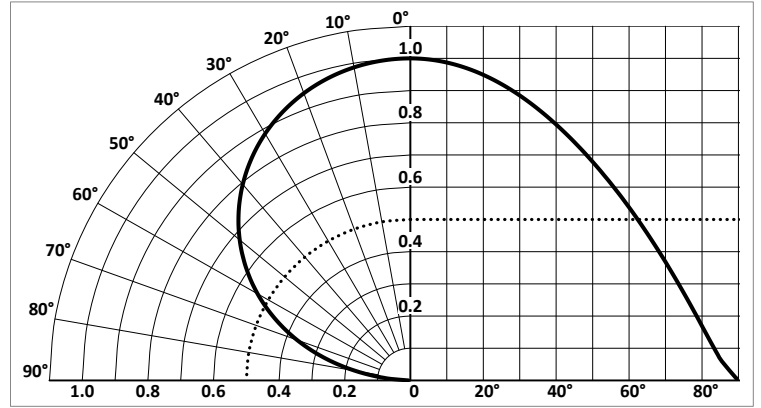

Color Over Angle

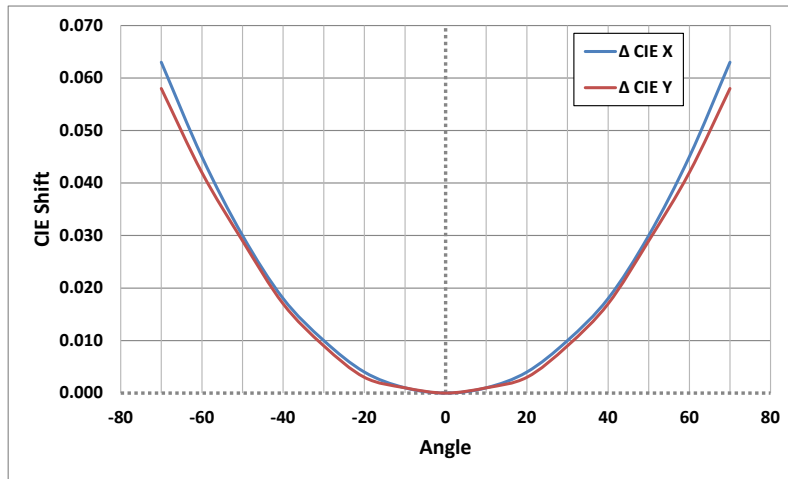

Thermal Information

|                         |           |
|-------------------------|-----------|
| Rth [j-c], Electrical   | 0.45 °C/W |
| Rth [j-ref], Electrical | 0.5 °C/W  |

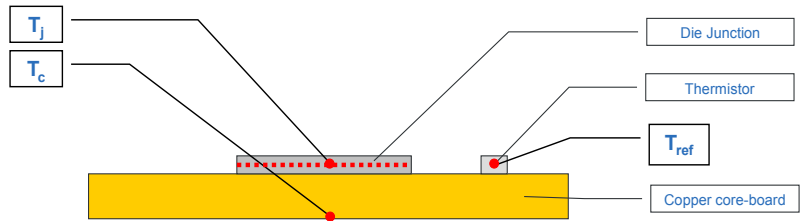

Electrical Pinout

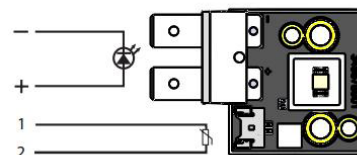

The thermistor used in CFT-90 LEDs mounted on core-boards is from Murata Manufacturing Co. The global part number is NCP18XH103J03RB. Please see <http://www.murata.com/> for details on calculating thermistor temperature.

**Important notice: please note that the CFT-90-W copper PCB is electrically active with a common cathode polarity**

## Mechanical Dimensions<sup>1,2</sup>

DIMENSIONS IN MILLIMETERS

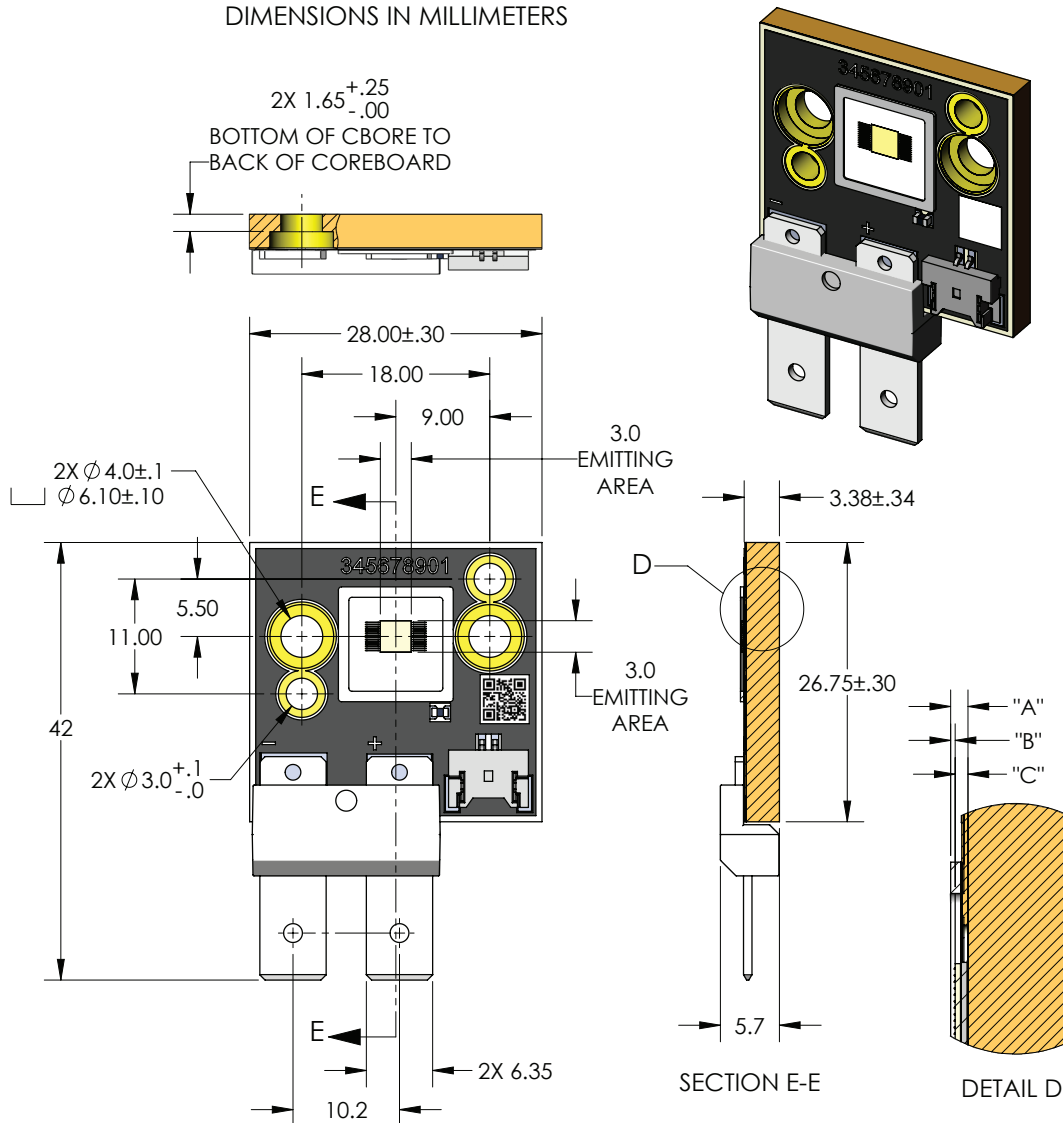

| DIMENSION NAME | DESCRIPTION                                    | NOMINAL DIMENSION | TOLERANCE |
|----------------|--|-------------------|-----------|
| "A"            | TOP OF METAL SUBSTRATE TO TOP OF FRAME         | .55               | ±.08      |
| "B"            | TOP OF EMITTING AREA TO TOP OF FRAME           | .14               | ±.12      |
| "C"            | TOP OF METAL SUBSTRATE TO TOP OF EMITTING AREA | .41               | ±.04      |

Note 1: Recommended connector for Anode and Cathode: Panduit Disco Lok™ Series P/N: DNG14-250FL-C.  
 Thermistor connector on Luminus coreboard: MOLEX P/N 53780-0270 (alternate: GCT P/N WTBO8-021S-F).  
 Recommended female thermistor connector: MOLEX P/N 51146-0200 (alternate: GCT P/N WTBO6-021S or equivalent).  
 For detailed drawing please refer to document DWG-002705.

Note 2: Some discoloration on the back of the coreboard is possible and is an expected consequence of the assembly process. The discoloration does not affect the thermal properties or reliability of the product.

Note 3: Due to the nature of the manufacturing process used for this product, the phosphor element may exhibit localized cosmetic edge irregularities of up to 100 um compared to nominal drawings.

### Shipping Tray Outline

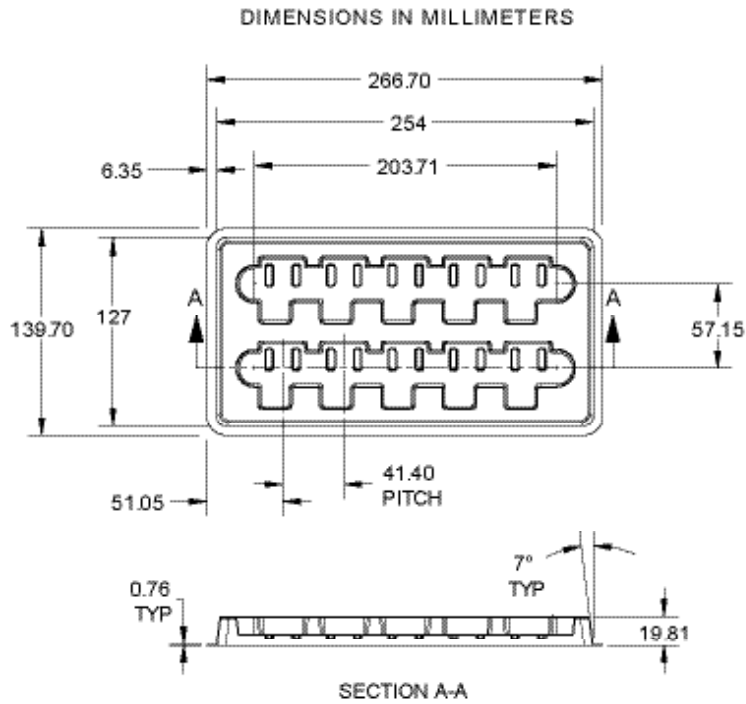

For detailed drawing of shipping trays, please refer to document TO-0479, available upon request.

## Packing and Shipping Specification

### Packing Specification

| Packing Configuration   | Qty /Pack | Dimensions (mm) | Gross Weight (kg) |
|---|-----------|-----------------|-------------------|
| Stack of 5 trays with 10 devices per tray<br>Each pack is enclosed in ESD bag | 50        | 150 x 280 x 85  | 2.7               |

### Product Label Specification

#### Label Fields (subject to change):

- 6-8 digit Box number (for Luminus internal use)
- Luminus ordering part number
- Quantity of devices in pack
- Part number revision (for Luminus internal use)
- Customer's part number (optional)
- Bin (FF-WW) as defined page 3
- 2D Bar code



Sample label –for illustration only



### Shipping Box

| Shipping Box | Quantity                           | Material | Dimensions (L x W x H, mm) |
|--------------|------------------------------------|----------|----------------------------|
| Carton Box   | 1 -20 packs<br>(50 - 1000 Devices) | S4651    | 560 x 560 x 200            |

