

IEC Appliance Inlet C14 with Filter, Fuseholder 1- or 2-pole (5x20 mm or 6.3x32 mm), Line Switch 1- or 2-pole, Voltage Selector (Series-Parallel)



See below:
[Approvals and Compliances](#)

Description

- Panel mount :
Screw-on mounting front side
- 5 Functions :
Appliance Inlet , Line Switch , Fuseholder with interchangeable fuse drawer for Fuse-links 5x20 mm or 6.3x32 mm , Voltage Selector (series-parallel) , Line filter in standard and medical version
- Quick connect terminals 4.8 x 0.8 mm

Characteristics

- All single elements are already partially wired
- For added safety "Extra-Safe" fuse drawers are available
- For applications according IEC/UL 62368-1 we recommend variants with bleed resistor
- Suitable for use in medical equipment according to IEC/UL 60601-1 (1 MOOP, 1 MOPP)

References

- Alternative: version without line filter [KG](#)
- Alternative: Standard version

Weblinks

[pdf data sheet](#), [html datasheet](#), [General Product Information](#), [Approvals](#), [Distributor-Stock-Check](#), [Accessories](#), [Detailed request for product](#)

Newly available variants corresponding to V-Lock mating cordset. The connector is equipped with a notch intended for use with the latching cordset. The cord latching system prevents against accidental removal of the cordset.

Technical Data

| | | | |
|---------------------------------|---|-----------------------------------|--|
| Ratings IEC | 1 - 10A @ Ta 40 °C / 250VAC; 50Hz | Appliance inlet/-outlet | C14 acc. to IEC 60320-1, UL 498, CSA C22.2 no. 42 (for cold conditions) pin-temperature 70 °C, 10A, Protection Class I |
| Ratings UL/CSA | 1 - 10A @ Ta 40 °C / 250VAC; 60Hz | Fuseholder | 1-/2-pole, Shocksafe category PC2 acc. to IEC 60127-6, for fuse-links 5 x 20 / 6.3 x 32 mm |
| Leakage Current | standard < 0.5 mA (250 V / 60 Hz) medical < 5 µA (250 V / 60 Hz) | Rated Power Acceptance @ Ta 23 °C | 5 x 20: 2.5W (1 pole)/ 2W (2-pole) per pole 6.3 x 32: 3.15W (1 pole)/ 2.5W (2-pole) per pole |
| Dielectric Strength | > 1.7 kVDC between L-N > 2.7 kVDC between L/N-PE Test voltage (2 sec) | Power Acceptance @ Ta > 23°C | Admissible power acceptance at higher ambient temperature see derating curves |
| Allowable Operation Temperature | -25 °C to 85 °C | Line Switch | 2-pole, non-illuminated, acc. to IEC 61058-1 Technical Details |
| Climatic Category | 25/085/21 acc. to IEC 60068-1 | Voltage Selector | series-parallel, 4, 3 or 2 switch positions or usable as 2-pole change-over switch |
| IP-Protection | front side IP40 acc. to IEC 60529 | Line Filter | Standard and Medical Version, IEC 60939, UL 1283, CSA C22.2 no. 8 Technical Details |
| Protection Class | Suitable for appliances with protection class I acc. to IEC 61140 | MTBF | > 1'100'000h acc. to MIL-HB-217 F |
| Terminal | Quick connect terminals 4.8 x 0.8 mm | | |
| Panel Thickness S | Screw: max 8 mm Mounting screw torque max 0.5 Nm | | |
| Material: Housing | Thermoplastic, black, UL 94V-0 | | |

Approvals and Compliances



Detailed information on product approvals, code requirements, usage instructions and detailed test conditions can be looked up in [Details about Approvals](#)

SCHURTER products are designed for use in industrial environments. They have approvals from independent testing bodies according to national and international standards. Products with specific characteristics and requirements such as required in the automotive sector according to IATF 16949, medical technology according to ISO 13485 or in the aerospace industry can be offered exclusively with customer-specific, individual agreements by SCHURTER.

Approvals









The approval mark is used by the testing authorities to certify compliance with the safety requirements placed on electronic products.

Approval Reference Type: CG

| Approval Logo | Certificates | Certification Body | Description |
|--|---------------|--------------------|---|
|  | VDE Approvals | VDE | Certificate Number: 40004665 (FKSA, FKSB) |
|  | UL Approvals | UL | UL File Number: E72928 (FKSA, FKSB) |



Product standards

Product standards that are referenced

| Organization | Design | Standard | Description |
|--|-----------------------|------------------|---|
|  | Designed according to | IEC 60320-1 | Appliance couplers for household and similar general purposes |
|  | Designed according to | IEC 60939 | Passive filters for suppressing electromagnetic interference |
|  | Designed according to | IEC 60127-6 | Miniature fuses. Part 6. Fuse-holders for miniature fuse-links |
|  | Designed according to | IEC 61058-1 | Switches for appliances. Part 1. General requirements |
|  | Designed according to | UL 498 | Standard for Attachment Plugs and Receptacles |
|  | Designed according to | UL 1283 | Electromagnetic interference filters |
|  | Designed according to | CSA C22.2 no. 42 | General Use Receptacles, Attachment Plugs, and Similar Wiring Devices |
|  | Designed according to | CSA C22.2 no. 8 | Electromagnetic interference (EMI) filters |









Application standards

Application standards where the product can be used

| Organization | Design | Standard | Description |
|--|--------------------------------|----------------|--|
|  | Designed for applications acc. | IEC/UL 62368-1 | Audio/video, information and communication technology equipment - Part 1: Safety requirements |
|  | Designed for applications acc. | IEC 60601-1 | Medical electrical equipment - Part 1: General requirements for basic safety and essential performance |
|  | Designed for applications acc. | IEC 60335-1 | Safety of electrical appliances for household and similar purposes. Meets the requirements for appliances in unattended use. This includes the enhanced requirements of glow wire tests acc. to IEC 60695-2-11 or -12 & -13. |

Compliances

The product complies with following Guide Lines

| Identification | Details | Initiator | Description |
|--|--------------------------------|-------------|--|
|  | CE declaration of conformity | SCHURTER AG | The CE marking declares that the product complies with the applicable requirements laid down in the harmonisation of Community legislation on its affixing in accordance with EU Regulation 765/2008. |
|  | UKCA declaration of conformity | SCHURTER AG | The UKCA marking declares that the product complies with the applicable requirements laid down in the British Amendment of Regulation (EC) 765/2008. |
|  | RoHS | SCHURTER AG | Directive RoHS 2011/65/EU, Amendment (EU) 2015/863 |
|  | China RoHS | SCHURTER AG | The law SJ / T 11363-2006 (China RoHS) has been in force since 1 March 2007. It is similar to the EU directive RoHS. |
|  | REACH | SCHURTER AG | On 1 June 2007, Regulation (EC) No 1907/2006 on the Registration, Evaluation, Authorization and Restriction of Chemicals 1 (abbreviated as "REACH") entered into force. |
|  | | SCHURTER AG | V-Lock system are based on a matching plug-dose combination. The connector is equipped with a notch intended for use with the latching cordset. The cord latching system prevents against accidental removal of the cordset. |
|  | White Paper Glow wire test | SCHURTER AG | Meets the requirements of IEC 60335-1 for appliances in unattended use. This includes the enhanced requirements of glow wire tests acc. to IEC 60695-2-11 or -12 & -13. |
|  | Medical Equipment | SCHURTER AG | Suitable for use in medical equipment according to IEC/UL 60601-1 (1 MOOP, 1 MOPP) |

Dimension [mm]
 CG

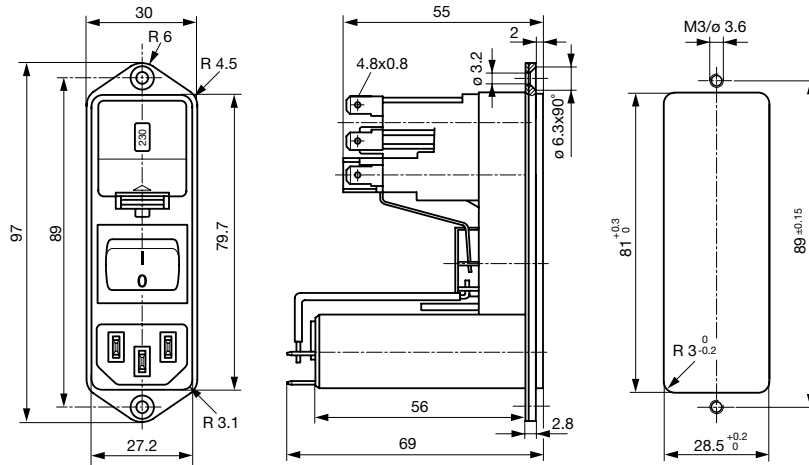

Technical Data of Filter-Components

| Rated Current [A] | Filter-Type | Inductances L [mH] | Capacitance CX [nF] | Capacitance CY [nF] | R [MΩ] |
|-------------------|----------------------|--------------------|---------------------|---------------------|--------|
| 1 | Standard version | 2 x 10 | 68 | 2.2 | - |
| 2 | Standard version | 2 x 4 | 68 | 2.2 | - |
| 4 | Standard version | 2 x 1.5 | 68 | 2.2 | - |
| 6 | Standard version | 2 x 0.8 | 68 | 2.2 | - |
| 10 | Standard version | 2 x 0.3 | 68 | 2.2 | - |
| 1 | Medical Version (M5) | 2 x 10 | 68 | - | 1 |
| 2 | Medical Version (M5) | 2 x 4 | 68 | - | 1 |
| 4 | Medical Version (M5) | 2 x 1.5 | 68 | - | 1 |
| 6 | Medical Version (M5) | 2 x 0.8 | 68 | - | 1 |
| 10 | Medical Version (M5) | 2 x 0.3 | 68 | - | 1 |

Diagrams

Standard version
 with fuseholder 1- or 2-pole

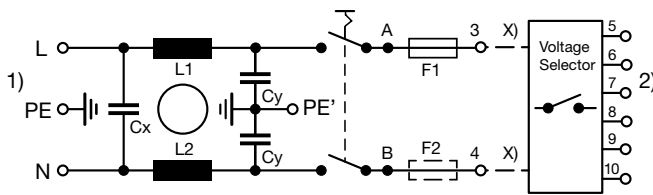

x) external connection to be made by the customer

- 1) Line
- 2) Load

Medical Version (M5)
 with 2-pole fuseholder

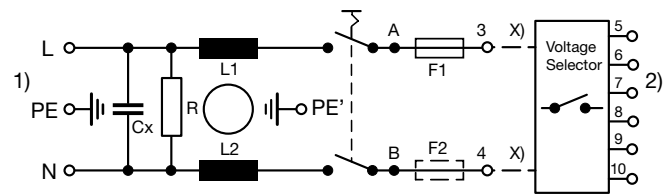

x) external connection to be made by the customer

- 1) Line
- 2) Load

Derating Curves

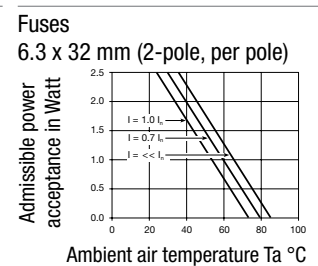
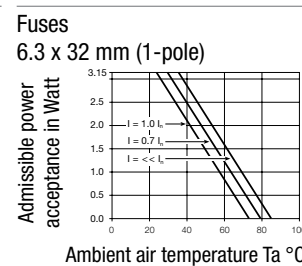
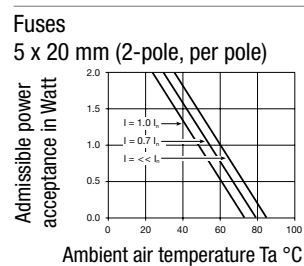
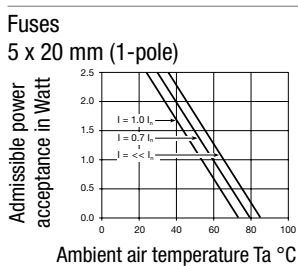

Attenuation Loss

--- 50Ω differential mode ___ 50Ω common mode

Standard version

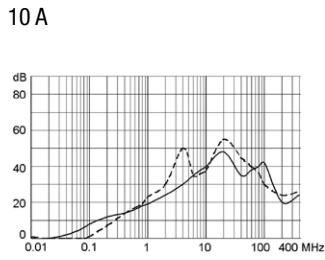
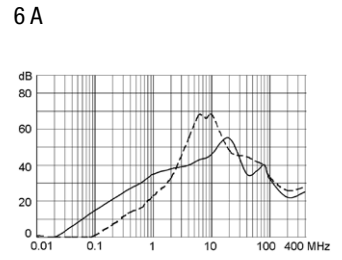
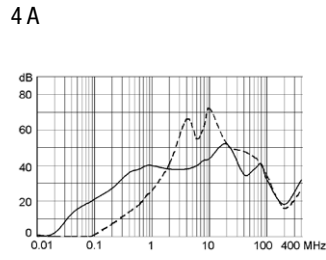
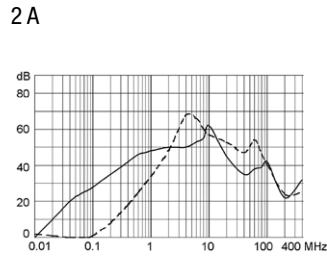
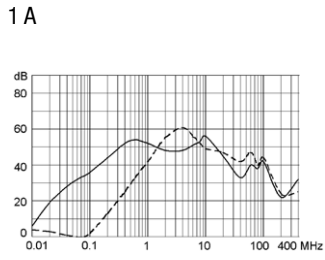

Medical version (M5)

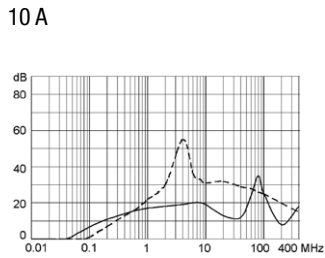
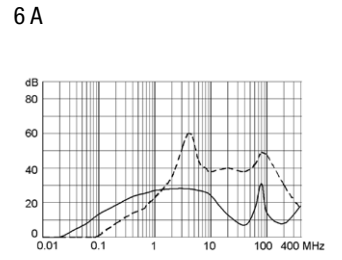
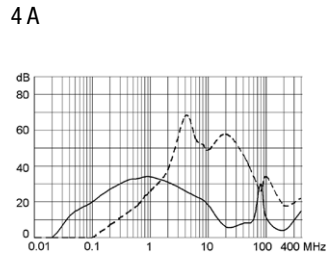
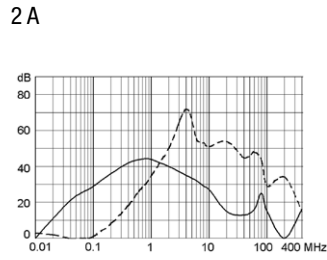
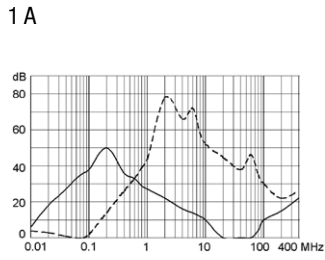

All Variants

| Type | Rated Current [A] | Filter-Type | Fuseholder | Line Switch | Line Switch | Order Number |
|------|-------------------|----------------------|------------|-------------|-------------|---------------|
| CG | 1 | Standard version | 1-pole | 2-pole | - | CG16.5101.151 |
| CG | 2 | Standard version | 1-pole | 2-pole | - | CG26.5101.151 |
| CG | 4 | Standard version | 1-pole | 2-pole | - | CG36.5101.151 |
| CG | 6 | Standard version | 1-pole | 2-pole | - | CG46.5101.151 |
| CG | 10 | Standard version | 1-pole | 2-pole | - | CG66.5101.151 |
| CG | 1 | Standard version | 2-pole | 2-pole | - | CG10.6101.151 |
| CG | 2 | Standard version | 2-pole | 2-pole | - | CG20.6101.151 |
| CG | 4 | Standard version | 2-pole | 2-pole | - | CG30.6101.151 |
| CG | 6 | Standard version | 2-pole | 2-pole | - | CG40.6101.151 |
| CG | 10 | Standard version | 2-pole | 2-pole | - | CG60.6101.151 |
| CG | 1 | Medical Version (M5) | 2-pole | 2-pole | - | CGG0.6101.151 |
| CG | 2 | Medical Version (M5) | 2-pole | 2-pole | - | CGA0.6101.151 |
| CG | 4 | Medical Version (M5) | 2-pole | 2-pole | - | CGC0.6101.151 |
| CG | 6 | Medical Version (M5) | 2-pole | 2-pole | - | CGE0.6101.151 |
| CG | 10 | Medical Version (M5) | 2-pole | 2-pole | - | CGL0.6101.151 |

Most Popular.

| Type | Rated Current [A] | Filter-Type | Fuseholder | Line Switch | Line Switch | Order Number |
|------|-------------------|-------------|------------|-------------|-------------|--------------|
|------|-------------------|-------------|------------|-------------|-------------|--------------|

Availability for all products can be searched real-time: <https://www.schurter.com/en/Stock-Check/Stock-Check-SCHURTER>

The fuse drawer is not included and must be ordered separately (see required accessory).

Suffix ".21" corresponds to the version with V-Lock mating cordset. The connector is equipped with a notch intended for use with the latching cordset. The cord latching system prevents against accidental removal of the cordset.

| | |
|-----------------------|--------|
| Packaging unit | 10 Pcs |
|-----------------------|--------|

Required Accessory

Description



Fusedrawer 1
 Fusedrawer for Fuse Links 5x20 mm resp. 6.3x32 mm

| | |
|------------------|-----------|
| 5 x 20, 2-pole | 4305.0001 |
| 5 x 20, 1-pole | 4305.0006 |
| 6.3 x 32, 2-pole | 4305.0011 |
| 6.3 x 32, 1-pole | 4305.0016 |
| ... | ... |



Jumper Wire 1
 Connection with Stranded Cable

| | |
|----------------|-----------|
| Type A, 70 mm | 0881.0074 |
| Type A, 100 mm | 0881.0075 |
| Type B, 70 mm | 0881.0076 |
| Type B, 100 mm | 0881.0077 |



Voltage Selectors Insert 1
 Voltage Selector Insert to KE, CE, KG, CG

| | |
|--|--------------|
| 3 or 4 switch positions | 4305.0048.00 |
| 1, 3 or 4 switch positions, 100, 120, 220, 240 | 4305.0048.01 |
| 3, 3 or 4 switch positions, 130, 110, 240, 220 | 4305.0048.02 |
| 2, 2 switch positions, 110, 220 | 4305.0048.03 |
| ... | ... |

Accessories



Assorted Covers
 Rear Cover

| |
|-----------|
| 0859.0109 |
|-----------|



RC320
 Rear Cover for Power Entry Module