

CG5 and SL0902A Series

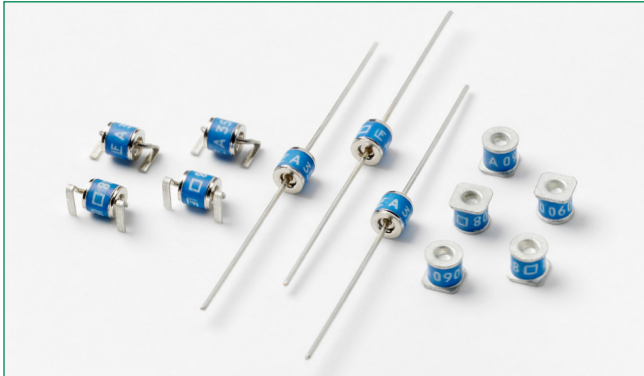

**Description**

Littelfuse Broadband Optimized™ SL0902A Series offers high surge ratings in a miniature package. Special design features provide high levels of protection against fast rising transients in the 100V/μs to 1kV/μs range usually caused by lightning disturbances. Low insertion loss is perfectly suited to broadband equipment applications. The capacitance does not vary with voltage, and will not cause operational problems with ADSL2+, where capacitance variation across Tip and Ring is undesirable. These devices are extremely robust and are able to divert a 2500A pulse without destruction. For AC Power Cross of long duration, overcurrent protection is recommended.

Littelfuse CG5 MS mini surge arresters are specifically designed for protection of electrical and communication equipment against over voltage transients in surface mount assembly applications. This series offers the most cutting edge protection using non-radioactive elements.

**Agency Approvals**

Agency	Agency File Number
	E128662

**2 Electrode GDT Graphical Symbol**

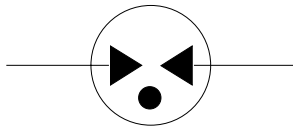

**Features**

- RoHS compliant and Lead-free
- GHz working frequency
- Excellent stability on multiple pulse duty cycle
- Excellent response to fast rising transients.
- Ultra Low Insertion Loss
- 5KA surge capability tested with 8/20μS pulse as defined by IEC 61000-4-5, 2nd edition
- Ultra small devices offered in a variety of mounting lead forms
- Non-Radioactive
- Low capacitance (<1pF)
- Voltage Ranges 90V to 600V
- UL Recognized
- Conforms to ITU-T K12, IEC 61000-4-5, 2nd edition

**Additional Information**



Datasheet  
CG5 Series



Resources  
CG5 Series



Samples  
CG5 Series



Datasheet  
SL0902A



Resources  
SL0902A



Samples  
SL0902A

**Applications**

- Communication equipment
- CATV equipment
- Test equipment
- Data lines
- Power supplies
- Telecom SLIC protection
- Broadband equipment
- ADSL equipment, including ADSL2+
- XDSL equipment
- Satellite and CATV equipment
- General telecom equipment

### Electrical Characteristics

Part Number	Device Specifications (at 25°C)						Life Ratings					
	DC Breakdown in Volts (@100V/s)			Impulse Breakdown in Volts (@100V/μs)	Impulse Breakdown In Volts (@1 Kv/μsec)	Insulation Resistance	Capacitance (@1MHz)	Surge Life (10/1000μs)	Nominal Impulse Discharge Current (8/20μs)	Nominal AC Discharge Current (10x1sec @50-60Hz)	AC Discharge Current (9 cycle @50Hz)	Max Impulse Discharge Current (1 Application @ 10/350μs)
	MIN	TYP	MAX	MAX		MIN	MAX					
SL0902A090 CG590	72	90	108	550	700	10 <sup>10</sup> Ω (at 50V)	1.5 pf	300 shots (@100A)	10 shots (@5kA)	5 A	10 A	0.5kA
CG5145	116	145	174	550	650	10 <sup>10</sup> Ω (at 100V)						
CG5150	120	150	180	550	-							
SL0902A230 CG5230	184	230	276	550	650							
CG5250	200	250	300	600	-							
CG5270*	216	270	324	650	-							
SL0902A350 CG5350	280	350	420	800	900							
CG5400	320	400	480	900	-							
SL0902A420*	336	420	504	900	1000							
CG5470	376	470	564	1000	1200							
SL0902A600 CG5600	480	600	720	1350	1500							

\* - Particular component is not UL Recognized.

### Product Characteristics

<b>Materials</b>	<b>CG5xxxLS (Outline 500), CG5xxxxLTR &amp; CG5350L-03TR (Outline 502), and CG5xxxL-02 (Outline 503):</b> Device Nickel Plated 2-5 Microns Wire Tin Plated 17.5±12.5 Microns Construction Ceramic Insulator.	<b>Product Marking</b>	LF Logo, Voltage and date code
	<b>CG5xxx (Outline 501), and CG5xxxMS &amp; SL0902AxxxSM (Outline 505):</b> Device Tin Plated 17.5±12.5 Microns Construction Ceramic Insulator.	<b>Glow to arc transition current</b>	< 0.5Amps
		<b>Glow Voltage</b>	140 Volts
		<b>Storage and Operational Temperature</b>	-40 to +90

### Voltage vs. Time Characteristic

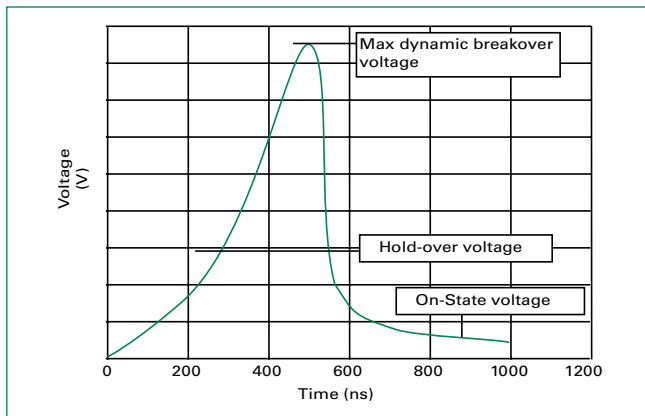

### Typical Insertion Loss

@ 1.0 GHz = 0.01 dB
@ 1.4GHz = 0.1 dB
@ 1.8 GHz = 0.53 dB
@ 2.1 GHz = 0.81 dB
@ 2.45 GHz= 1 dB
@ 2.8 GHz = 1.2 dB
@ 3.1 GHz = 1.5 dB
@ 3.5 GHz = 2.1 dB

**Device Dimensions**

**Outline 500 - CG5xxxLS**

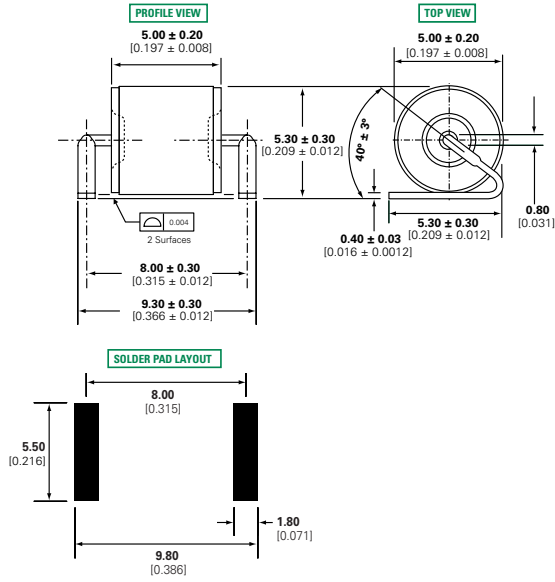

**Outline 503 - CG5xxxL-02** (except CG5600L-02, see Outline 502)

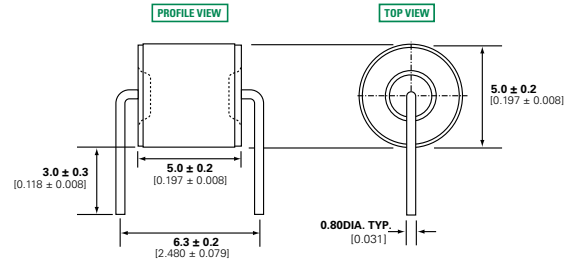

**Outline 505 - CG5xxxMS and SL0902AxxxSM**

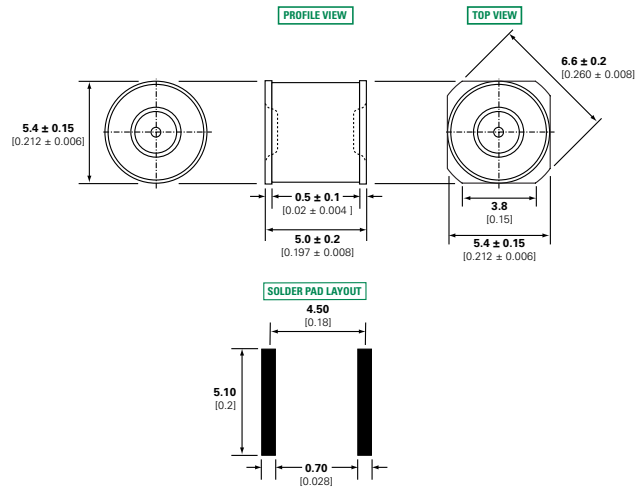

**Outline 501 - CG5xxx**

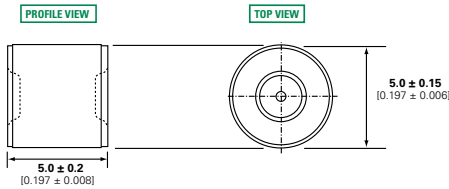

**Outline 502 - CG5xxxLTR** (also CG5350L-03TR, CG5600L-02)

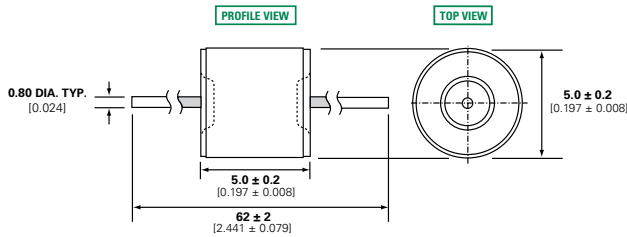

**Soldering Parameters - Reflow Soldering (Surface Mount Devices)**

Reflow Condition		Pb – Free assembly
Pre Heat	- Temperature Min ( $T_{s(min)}$ )	150°C
	- Temperature Max ( $T_{s(max)}$ )	200°C
	- Time (Min to Max) ( $t_p$ )	60 – 180 secs
Average ramp up rate (Liquidus Temp ( $T_L$ ) to peak)		3°C/second max
$T_{s(max)}$ to $T_L$ - Ramp-up Rate		5°C/second max
Reflow	- Temperature ( $T_L$ ) (Liquidus)	217°C
	- Temperature ( $t_L$ )	60 – 150 seconds
Peak Temperature ( $T_p$ )		260 <sup>+0/-5</sup> °C
Time within 5°C of actual peak Temperature ( $t_p$ )		10 – 30 seconds
Ramp-down Rate		6°C/second max
Time 25°C to peak Temperature ( $T_p$ )		8 minutes Max.
Do not exceed		260°C

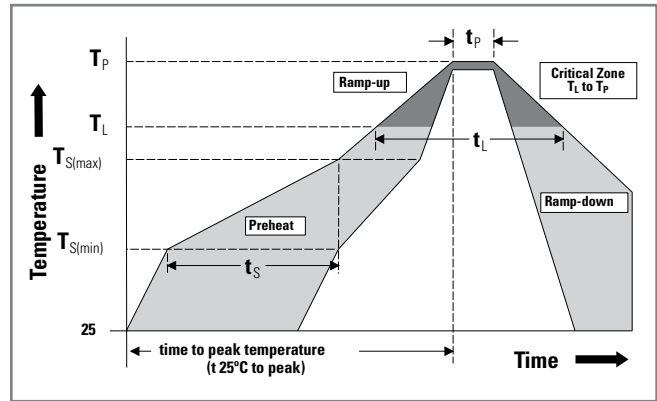

**Soldering Parameters - Hand Soldering**

Solder Iron Temperature: 350° C +/- 5°C  
Heating Time: 5 seconds max.

**Soldering Parameters - Wave Soldering (Thru-Hole Devices)**

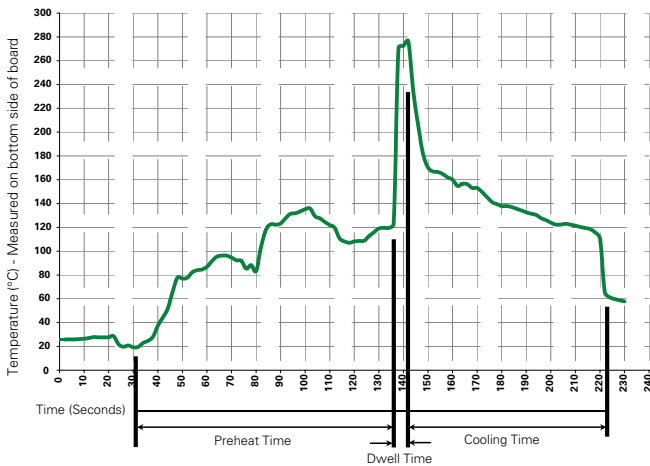

**Recommended Process Parameters:**

Wave Parameter	Lead-Free Recommendation
<b>Preheat:</b> (Depends on Flux Activation Temperature)	(Typical Industry Recommendation)
<b>Temperature Minimum:</b>	100° C
<b>Temperature Maximum:</b>	150° C
<b>Preheat Time:</b>	60-180 seconds
<b>Solder Pot Temperature:</b>	280° C Maximum
<b>Solder Dwell Time:</b>	2-5 seconds

**Note:** These devices are not recommended for IR or Convection Reflow process.