

CGHV40180F

180 W, DC - 2.0 GHz, 50 V, GaN HEMT

Description

Cree's CGHV40180F is an unmatched, gallium nitride (GaN) high electron mobility transistor (HEMT). The CGHV40180F, operating from a 50 volt rail, offers a general purpose, broadband solution to a variety of RF and microwave applications. GaN HEMTs offer high efficiency, high gain and wide bandwidth capabilities making the CGHV40180F ideal for linear and compressed amplifier circuits. The transistor is available in a 2-lead flange package.



Package Type: 440223
PN: CGHV40180F

Typical Performance Over 800 MHz - 1000 MHz ($T_c = 25^\circ\text{C}$), 50 V

Parameter	800 MHz	850 MHz	900 MHz	950 MHz	1000 MHz	Units
Small Signal Gain	25.6	25.2	24.9	24.4	24.3	dB
Gain @ P_{IN} 34 dBm	20.4	20.8	20.3	20.1	20.1	dB
Output Power @ P_{IN} 34 dBm	275	302	279	257	257	W
EFF @ P_{IN} 34 dBm	67	75	73	73	71	%

Note: Measured CW in the CGHV40180F-AMP Application circuit

Features

- Up to 2.0 GHz Operation
- 24 dB Small Signal Gain at 900 MHz
- 20 dB Power Gain at 900 MHz
- 250 W Typical Output Power at 900 MHz
- 75% Efficiency at P_{SAT}

Applications

- Military Communications
- Public Safety VHF-UHF applications
- Radar
- Medical
- Broadband Amplifiers

 Large Signal Models Available for ADS and MWO

RoHS
COMPLIANT



Absolute Maximum Ratings (not simultaneous) at 25 °C Case Temperature

Parameter	Symbol	Rating	Units	Conditions
Drain-Source Voltage	V_{DSS}	150	Volts	25 °C
Gate-to-Source Voltage	V_{GS}	-10, +2	Volts	25 °C
Storage Temperature	T_{STG}	-65, +150	°C	
Operating Junction Temperature ¹	T_J	225	°C	
Maximum Forward Gate Current	I_{GMAX}	42	mA	25 °C
Maximum Drain Current ¹	I_{DMAX}	12.1	A	25 °C
Soldering Temperature ²	T_S	245	°C	
Screw Torque	τ	40	in-oz	
CGHV40180F Thermal Resistance, Junction to Case	$R_{\theta JC}$	0.95	°C/W	$P_{DISS} = 150, 85 \text{ °C}$
Maximum dissipated power		150	W	$P_{DISS} = 150, 85 \text{ °C}$
Case Operating Temperature ³	T_C	-40, +150	°C	

Notes:

¹ Current limit for long term, reliable operation

² Refer to the Application Note on soldering at wolfspeed.com/rf/document-library

³ See also, Power Derating Curve on Page 5

Electrical Characteristics

Characteristics	Symbol	Min.	Typ.	Max.	Units	Conditions
DC Characteristics¹ ($T_C = 25 \text{ °C}$)						
Gate Threshold Voltage	$V_{GS(th)}$	-3.8	-3.0	-2.3	V_{DC}	$V_{DS} = 10 \text{ V}, I_D = 41.8 \text{ mA}$
Gate Quiescent Voltage	$V_{GS(Q)}$	-	-2.7	-	V_{DC}	$V_{DS} = 50 \text{ V}, I_D = 1000 \text{ mA}$
Saturated Drain Current	I_{DS}	27.2	38.9	-	A	$V_{DS} = 6.0 \text{ V}, V_{GS} = 2.0 \text{ V}$
Drain-Source Breakdown Voltage	V_{BR}	125	-	-	V_{DC}	$V_{GS} = -8 \text{ V}, I_D = 41.8 \text{ mA}$
RF Characteristics² ($T_C = 25 \text{ °C}, F_0 = 900 \text{ MHz}$ unless otherwise noted)						
Small Signal Gain	G_{SS}	23.4	24.0	-	dB	$V_{DD} = 50 \text{ V}, I_{DQ} = 1.0 \text{ A}, P_{in} = 10 \text{ dBm CW}$
Power Gain	G_P	19.3	20.3	-	dB	$V_{DD} = 50 \text{ V}, I_{DQ} = 1.0 \text{ A}, P_{in} = 34 \text{ dBm CW}$
Output Power	P_{OUT}	53.7	54.3	-	dBm	$V_{DD} = 50 \text{ V}, I_{DQ} = 1.0 \text{ A}, P_{in} = 34 \text{ dBm CW}$
Drain Efficiency ³	η	64	74	-	%	$V_{DD} = 50 \text{ V}, I_{DQ} = 1.0 \text{ A}, P_{in} = 34 \text{ dBm CW}$
Output Mismatch Stress	VSWR	-	-	3 : 1	Ψ	No damage at all phase angles, $V_{DD} = 50 \text{ V}, I_{DQ} = 1.0 \text{ A}, P_{OUT} = 180 \text{ W CW}$
Dynamic Characteristics						
Input Capacitance	C_{GS}	-	57.8	-	pF	$V_{DS} = 50 \text{ V}, V_{GS} = -8 \text{ V}, f = 1 \text{ MHz}$
Output Capacitance	C_{DS}	-	13.7	-	pF	$V_{DS} = 50 \text{ V}, V_{GS} = -8 \text{ V}, f = 1 \text{ MHz}$
Feedback Capacitance	C_{GD}	-	1.23	-	pF	$V_{DS} = 50 \text{ V}, V_{GS} = -8 \text{ V}, f = 1 \text{ MHz}$

Notes:

¹ Measured on wafer prior to packaging

² Measurements are to be performed using Cree production test fixture AD-838292F-TB

³ Drain Efficiency = P_{OUT}/P_{DC}



CGHV40180F Typical Performance

Figure 1. Small Signal Gain and Return Loss versus Frequency measured in application circuit CGHV40180F
 $V_{DD} = 50\text{ V}, I_{DQ} = 1.0\text{ A}$

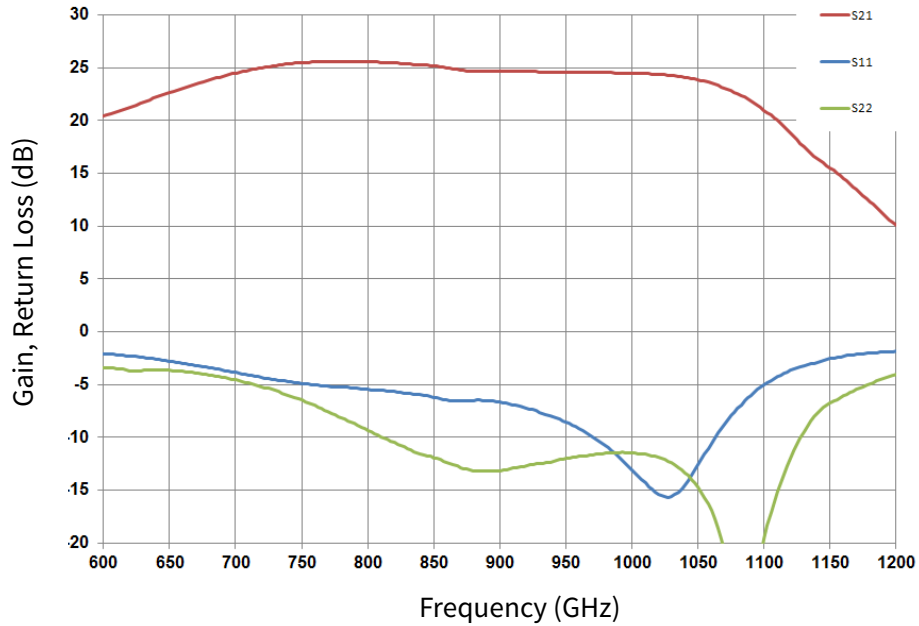
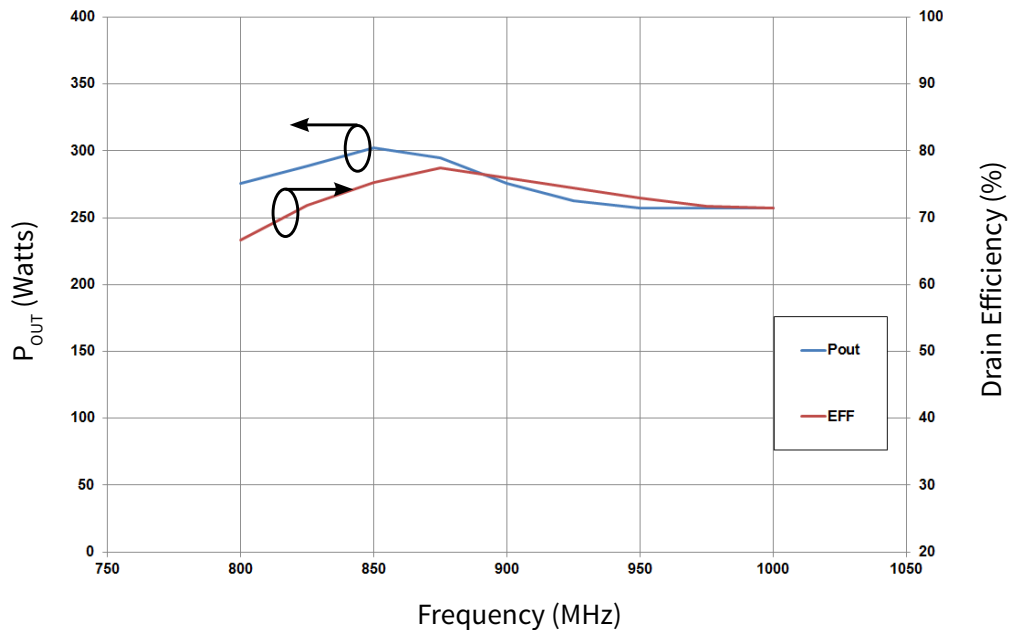

Figure 2. Output Power and Drain Efficiency vs Frequency CGHV40180F-TB
 CW Operation, $V_{DD} = 50\text{ V}, I_{DQ} = 1.0\text{ A}, @ P_{IN} 34\text{ dBm}$





CGHV40180F Typical Performance

Figure 3. Gain and Drain Efficiency vs. Frequency and Output Power CGHV40180F-TB
CW Operation, $V_{DD} = 50\text{ V}$, $I_{DQ} = 1.0\text{ A}$

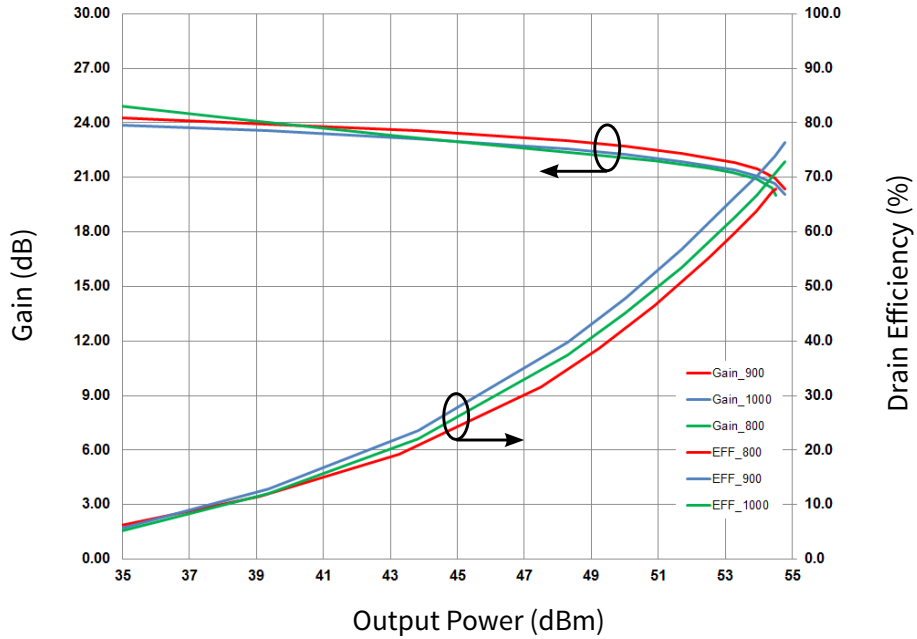
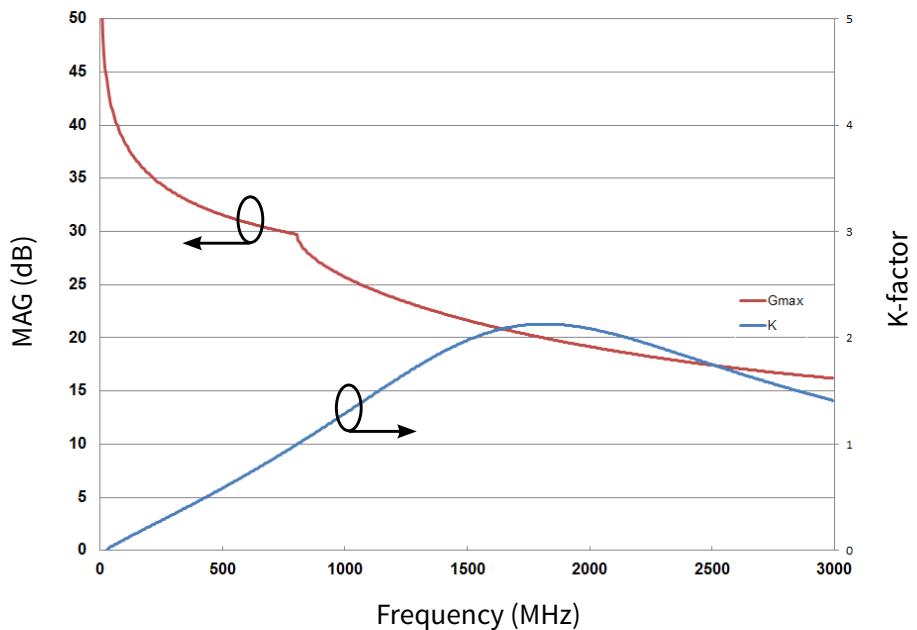

Figure 4. Simulated Maximum Available Gain and K-factor of the CGHV40180F
 $V_{DD} = 50\text{ V}$, $I_{DQ} = 1.0\text{ A}$





CGHV40180F Power Dissipation De-rating Curve

Figure 5. Transient Power Dissipation De-rating Curve

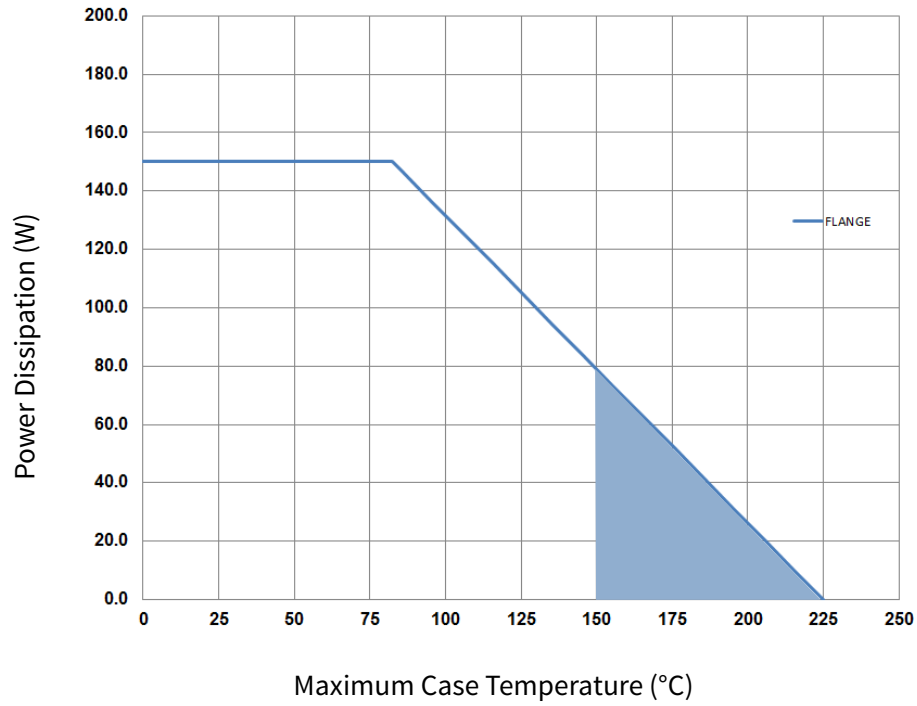



CGHV40180F-AMP Application Circuit Schematic

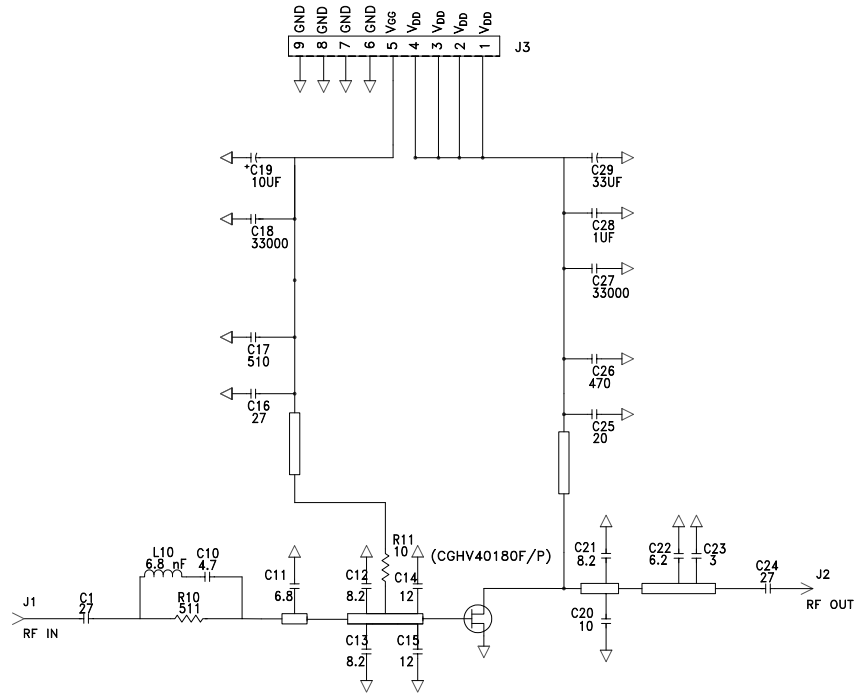

CGHV40180F-AMP Application Circuit

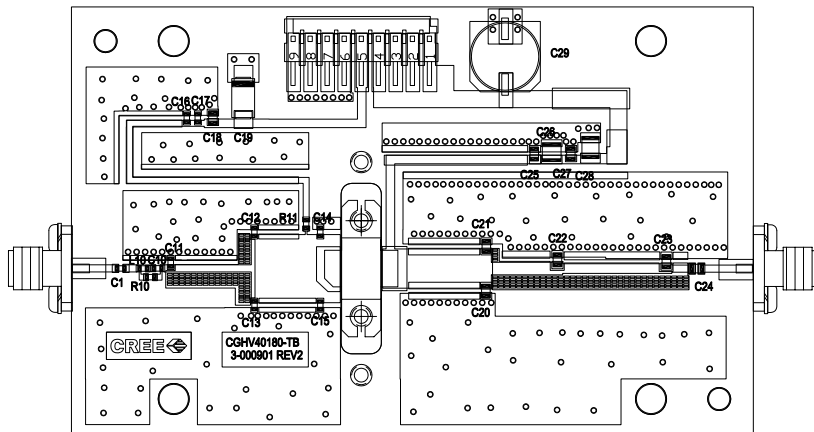

CGHV40180F-AMP Application Circuit Bill of Materials

Designator	Description	Qty
R11	RES, 1/16W, 0603, 1%, 10.0 OHMS	1
R10	RES, 1/16W, 0603, 1%, 511 OHMS	1
C29	CAP, 33UF, 20%, G CASE	1
C28	CAP 1.0UF, 100V, ±10%, X7R, 1210	1
C17	CAP, 510pF, NPO, 5%, 100V, 0603	1
C26	CAP, 470pF, NPO, 5%, 250V, ATC800B	1
C19	CAP, 10UF, 16V TANTALUM, 2312	1
C14, C15	CAP, 12.0pF, ±5%, 0603, ATC600S	2
C1, C16	CAP, 27pF, ±5%, 0603, ATC600S	2
C10	CAP, 4.7pF, ±0.1pF, 0603, ATC600S	1
C11	CAP, 6.8pF, ±0.25pF, 0603, ATC600S	1
C12, C13	CAP, 8.2pF, ±0.25 pF, 0603, ATC600S	2
C18, C27	CAP, 33000pF, 0805, 100V, X7R	2
C20	CAP, 10pF, ±1%, 250V, 0805, ATC600F	2
C25	CAP, 20pF, ±5%, 250V, 0805, ATC600F	1
C24	CAP, 27pF, ±5%, 250V, 0805, ATC600F	1
C23	CAP, 3.0pF, ±0.1pF, 250V, 0805, ATC600F	2
C22	CAP, 6.2pF, ±0.1pF, 250V, 0805, ATC600F	1
C21	CAP, 8.2pF, ±0.1pF, 250V, 0805 ATC600F	1
-	PCB ROGERS HTC6035, 0.020 THK, ER 3.60	1
J1,J2	CONN, SMA, PANEL MOUNT JACK, FLANGE, 4 HOLE BLUNT POST	2
J3	HEADER RT>PLZ .1CEN LK 9POS	1
L10	INDUCTOR, CHIP, 6.8nH, 5%, 0603 SMT, DIGIKEY 712-1432-1-ND	1
Q1	CGHV40180	1

CGHV40180F-AMP Demonstration Amplifier Circuit

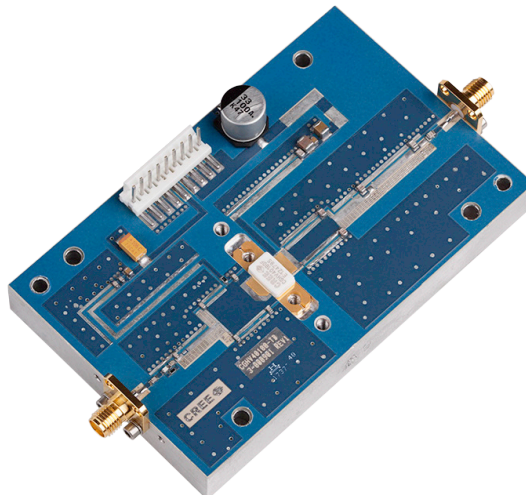



Electrical Characteristics When Tested in CGHV40180F-AMP3

Characteristics	Symbol	Min.	Typ.	Max.	Units	Conditions
RF Characteristics¹ ($T_c = 25^\circ\text{C}$, $F_0 = 0.96 - 1.215\text{ GHz}$ unless otherwise noted)						
Small Signal Gain	G_{SS}	-	> 20	-	dB	$V_{DD} = 50\text{ V}$, $I_{DQ} = 1.0\text{ A}$
Power Gain	G_P	-	> 16	-	dBm	$V_{DD} = 50\text{ V}$, $I_{DQ} = 1.0\text{ A}$, $P_{IN} = 38\text{ dBm}$, 128 μs , 10% pulse
Output Power	P_{OUT}	-	250	-	W	$V_{DD} = 50\text{ V}$, $I_{DQ} = 1.0\text{ A}$, $P_{IN} = 38\text{ dBm}$, 128 μs , 10% pulse
Drain Efficiency	η	-	> 75	-	%	$V_{DD} = 50\text{ V}$, $I_{DQ} = 1.0\text{ A}$, $P_{IN} = 38\text{ dBm}$, 128 μs , 10% pulse
Output Mismatch Stress	VSWR	-	3 : 1	-	Ψ	No damage at all phase angles, $V_{DD} = 50\text{ V}$, $I_{DQ} = 1.0\text{ A}$, $P_{IN} = 38\text{ dBm}$, 128 μs , 10% pulse

Notes:

¹Measured in CGHV40180F-AMP3 Application Circuit

Typical Performance in Application Circuit CGHV40180F-AMP3

Figure 5. Small Signal Gain and Return Losses of the CGHV40180F Measured in Demonstration Amplifier Circuit CGHV40180F-AMP3 CW Operation, $V_{DD} = 50\text{ V}$, $I_{DQ} = 1.0\text{ A}$

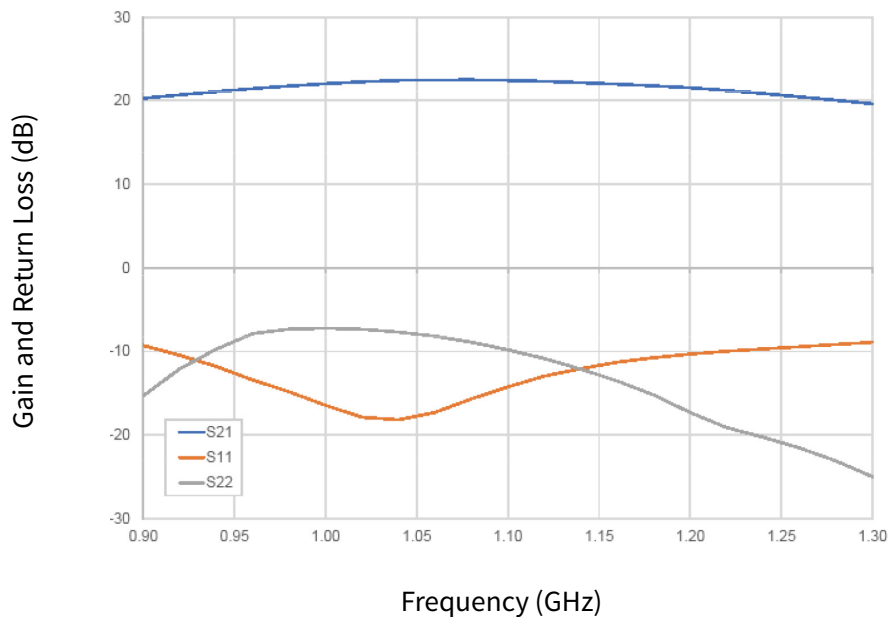



CGHV40180F-AMP3 Application Circuit Schematic

Figure 6. Pulsed Output Power and Drain Efficiency vs. Frequency of the CGHV40180F-AMP3
 $V_{DD} = 50\text{ V}$, $I_{DQ} = 1.0\text{ A}$, $P_{IN} = 38\text{ dBm}$, $128\ \mu\text{s}$, 10% pulse

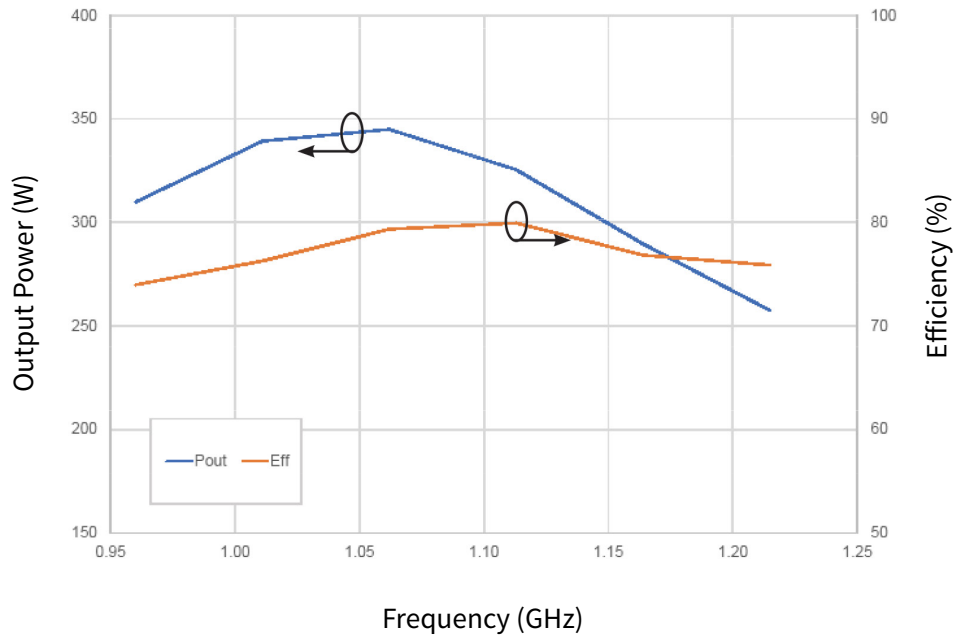
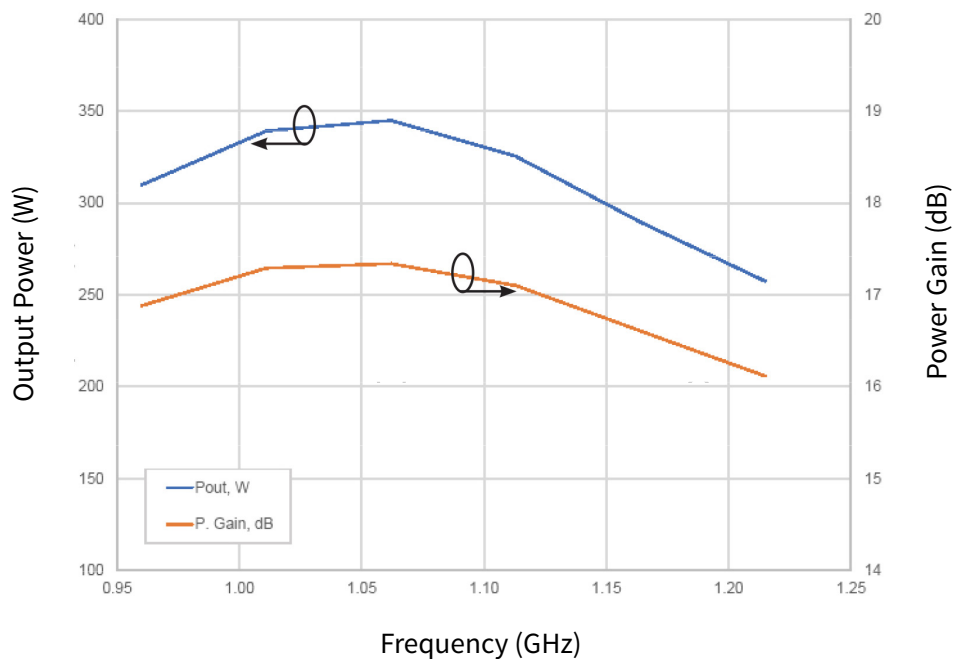
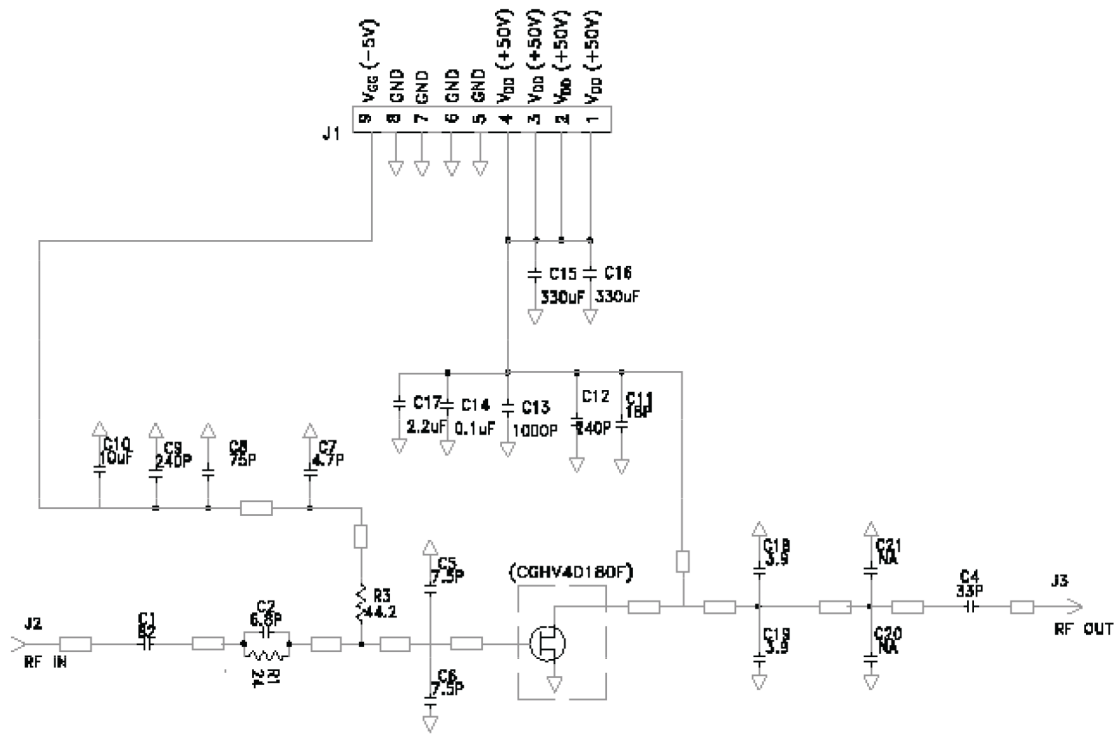

Figure 7. Output Power and Power Gain vs. Frequency of the CGHV40180F-AMP3
 $V_{DD} = 50\text{ V}$, $I_{DQ} = 1.0\text{ A}$, $P_{IN} = 38\text{ dBm}$, $128\ \mu\text{s}$, 10% pulse



CGHV40180F-AMP3 Application Circuit Schematic



CGHV40180F-AMP3 Application Circuit

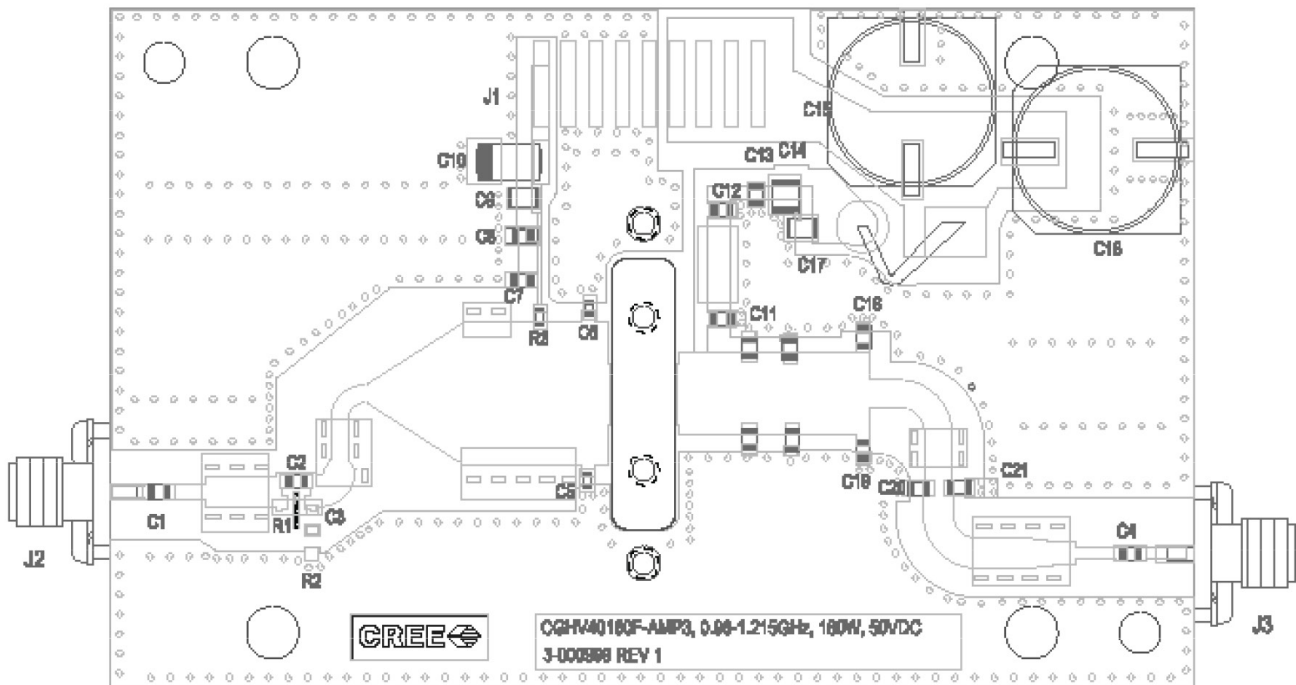

CGHV40180F-AMP3 Bill of Materials

Designator	Description	Qty
C2	CAP, 8.2pF, +/-0.1pF, 250V, 0805, ATC600F	1
C1	CAP, 82pF, 1%, 250V, 0805, ATC600F	1
C5, C6	CAP, 7.5PF, 1%, 0603, ATC600S	2
C9, C12	CAP, 240pF, 5%, 250V, 0805, ATC600F	1
C7	CAP, 4.7pF, +/-0.1pF, 250V, 0603, ATC600S	1
C8	CAP, 75pF, 5%, 250V, 0805, ATC600F	1
C11	CAP, 18pF, 1%, 250V, 0805, ATC600F	1
C13	CAP, 1000P, 5%, 250V, 0603	1
C14	CAP, 0.1uF, 5%, 250V, 0805	1
C17	CAP, 2.2uF, 5%, 100V, 1210	1
C15, C16	CAP, 330 UF, 20%, 100V, ELEC, Vishay, MAL215099911E3	2
C18, C19	CAP, 3.9pF, +/-0.1pF, 250V, 0805, ATC600F	2
C4	CAP, 33pF, 5%, 250V, 0805, ATC600F	1
C10	CAP, 10uF, 16V, TANTLUM	2
R1	RES, 24 OHM IMS, 1005	1
R3	RES, 1/16W, 0603, 1%, 44.2 OHMS	1
W1	WIRE, 18G, BALCK, 2.5"	1
J2, J3	CONN, SMA, PANEL MOUNT JACK, FL	2
J1	HEADER ST, .1CEN LK 9POS, PBC05SABN	1
-	BASEPLATE,	1
-	PCB, RO4350B, 2.5"x4"x0.020",	1
-	#2, WASHER, SPLIT LK, SS	4
-	2-56 SOC HD SCREW 3/16 SS	4
Q1	CGHV40180F	1

CGHV40180F-AMP3 Demonstration Amplifier Circuit



Source and Load Impedances

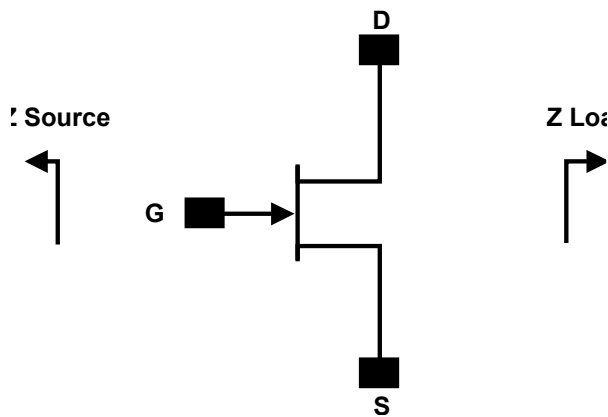

Frequency	Z Source	Z Load
50	23.7 + J25.9	7.6 + J0.6
150	7.4 + J8.3	8.1 + J0.7
250	4.2 + J7.9	7.9 + J2.2
500	1.4 + J1.5	4.7 + J2.7
750	1.0 + J0.0	3.9 + J2.3
1000	0.7 + J1.1	4.0 + J1.8

- Note 1. $V_{DD} = 50\text{ V}$, $I_{DQ} = 1.0\text{ A}$ in the 440223 package
- Note 2. Optimized for Power Gain, P_{SAT} and Drain Efficiency
- Note 3. When using this device at low frequency, series resistor should be used to maintain amplifier stability

Electrostatic Discharge (ESD) Classifications

Parameter	Symbol	Class	Test Methodology
Human Body Model	HBM	1A (> 250 V)	JEDEC JESD22 A114-D
Charge Device Model	CDM	2 (125 V to 250 V)	JEDEC JESD22 C101-C

Product Dimensions CGHV40180F (Package Type – 440223)

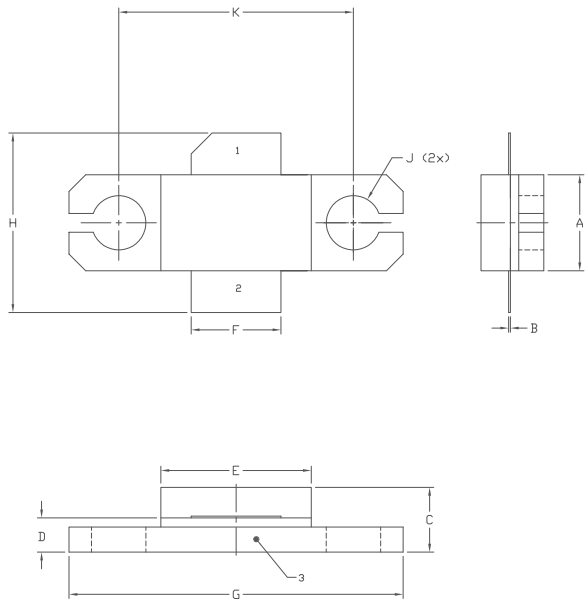

- NOTES:
1. DIMENSIONING AND TOLERANCING PER ANSI Y14.5M, 1982.
 2. CONTROLLING DIMENSION INCH.
 3. ADHESIVE FROM LID MAY EXTEND A MAXIMUM OF 0.020" BEYOND EDGE OF LID.
 4. LID MAY BE MISALIGNED TO THE BODY OF THE PACKAGE BY A MAXIMUM OF 0.008" IN ANY DIRECTION.
 5. ALL PLATED SURFACES ARE Ni/AU.

DIM	INCHES		MILLIMETERS	
	MIN	MAX	MIN	MAX
A	0.225	0.235	5.72	5.97
B	0.004	0.006	0.10	0.15
C	0.145	0.165	3.68	4.19
D	0.077	0.087	1.96	2.21
E	0.355	0.365	9.02	9.27
F	0.210	0.220	5.33	5.59
G	0.795	0.805	20.19	20.45
H	0.400	0.460	10.16	11.68
J	Ø .130		3.30	
k	0.562		14.27	

PIN 1. GATE
 PIN 2. DRAIN
 PIN 3. SOURCE

Part Number System

CGHV40180F



Table 1.

Parameter	Value	Units
Upper Frequency ¹	4.0	GHz
Power Output	100	W
Package	Flange	-

Note¹: Alpha characters used in frequency code indicate a value greater than 9.9 GHz. See Table 2 for value.

Table 2.

Character Code	Code Value
A	0
B	1
C	2
D	3
E	4
F	5
G	6
H	7
J	8
K	9
Examples:	1A = 10.0 GHz 2H = 27.0 GHz



Product Ordering Information

Order Number	Description	Unit of Measure	Image
CGHV40180F	GaN HEMT	Each	
CGHV40180F-AMP3	Test board with GaN HEMT (flanged) installed	Each	