

Mini contactors

Mini contactors providing various connections and Accessories

Ratings

Frame size	AC3 ratings (IEC60947-4)				AC1 rating lth
	220 ~ 240V	380 ~ 440V	500 ~ 550V	690V	
6A	1.5kW	2.2kW	3kW	3kW	20A
	7A	6A	5A	4A	
9A	2.2kW	4kW	3.7kW	4kW	20A
	9A	9A	6A	5A	
12A	3kW	5.5kW	4kW	4kW	20A
	12A	12A	7A	5A	

Screw clamps

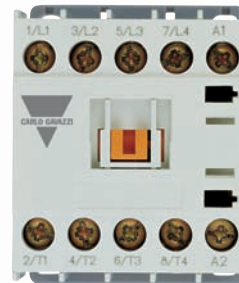

Fast-on

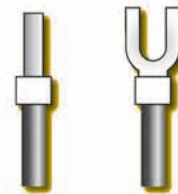
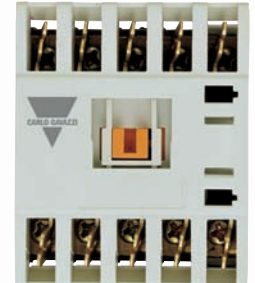

For conventional
screw connections

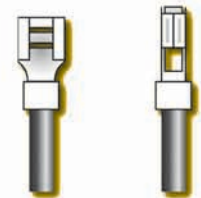

For fast-on
connections



Mini-overload relay



Overload relay
separately mounted

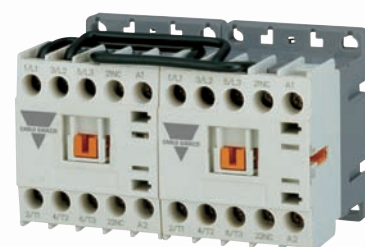

Reversing contactor

Cage clamps



Solder pins

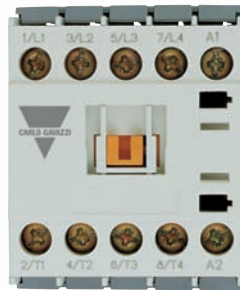

Dimensions,mm

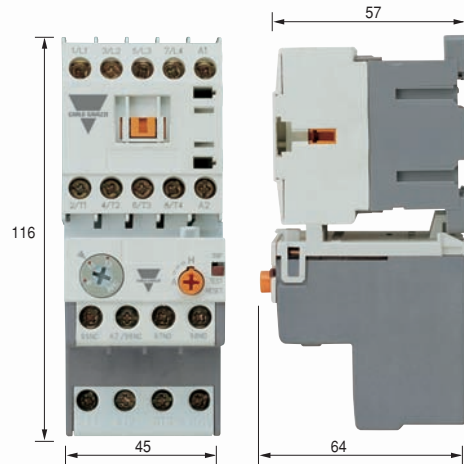

(Screw clamp type)

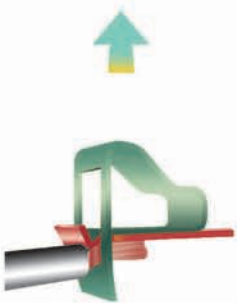

For screwless connections

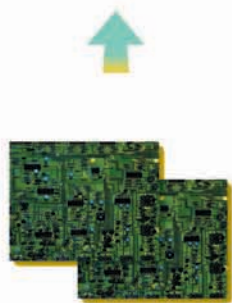

To mount on printed circuit boards

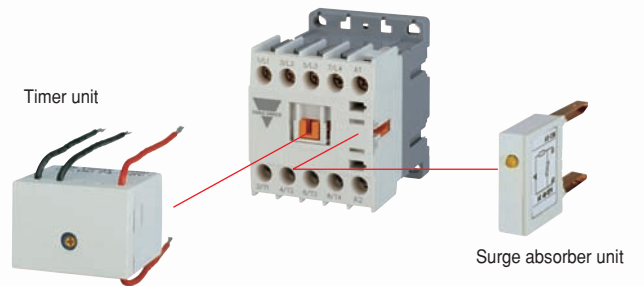
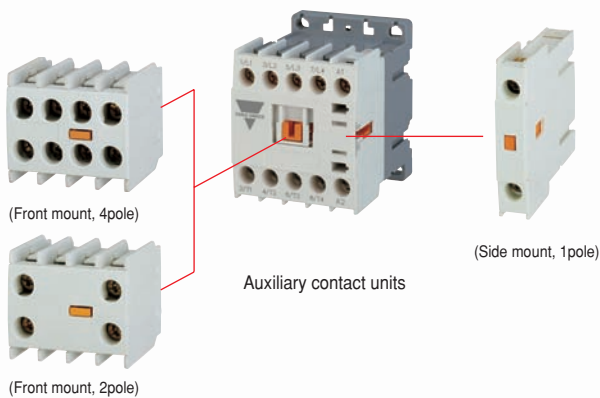

Quick selection table

Mini contactors & overloads

Mini contactors

3NO main contacts
1 auxiliary contacts



Screw clamp type



Fast-on type



Cage clamp type



Solder pin type

Frame size		6A		9A		12A	
Screw clamp type	AC coil	CGMS-6A		CGMS-9A		CGMS-12A	
	DC coil	CGMS-6D		CGMS-9D		CGMS-12D	
Fast-on type	AC coil	CGMF-6A		CGMF-9A		CGMF-12A	
	DC coil	CGMF-6D		CGMF-9D		CGMF-12D	
Cage clamp type	AC coil	CGMC-6A		CGMC-9A		CGMC-12A	
	DC coil	CGMC-6D		CGMC-9D		CGMC-12D	
Solder pin type	AC coil	CGMP-6A		CGMP-9A		CGMP-12A	
	DC coil	CGMP-6D		CGMP-9D		CGMP-12D	

Ratings / IEC60947-4		6A		9A		12A	
AC1		20		20		20	
AC3	200/240V	1.5	7	2.2	9	3	12
	380/440V	2.2	6	4	9	5.5	12
	690V	3	4	4	5	4	5

Ratings / UL508		6A		9A		12A	
continuous current		lth = 20A (maximum for cage clamp type is 10A)					
single phase	115V	0.5		0.5		1*	
	230V	1		1.5		2**	
three phase	200V	*		*		*	
	230V	1.5		3		3	
	460V	3		5		7.5***	
	575V	3		5		7.5	
NEMA size		00		00		00	

Additional auxiliary contacts	Screw clamp type	Fast-on type	Cage clamp type	Solder pin type
2-pole, Front mount	AX-2M	AX-2MF	AX-2MC	AX-1MP
4-pole, Front mount	AX-4M	AX-4MF	AX-4MC	
2-pole, Side mount	AX-1M	AX-1MF	AX-1MC	

See page 30 for more details

Overload Relays

Bimetallic style Type CGT Class 10A		Setting ranges (A) 0.1 - 0.16 0.16 - 0.25 0.25 - 0.4 0.4 - 0.63 0.63 - 1 1 - 1.6 1.6 - 2.5 2.5 - 4	4 - 6 5 - 8 6 - 9 7 - 10 9 - 13 12 - 16		See page 27 for more details
Differential	CGT-12M				
Non-differential (3-heater)	CGTH-12M/3				
Non-differential (2-heater)	CGTH-12M				

Note: * = 1/2 for cage clamp type, ** = 1.5hp for cage clamp type, *** = 5hp for cage clamp type

Contactors

- For motor control
- 3 main plus 1 auxiliary contacts
- Coil voltage : A.C.



Cage clamp connection types

Frame size	AC3 ratings (IEC60947-4)				AC1 rating Ith	Auxiliary contact (standard)	Type
	220 ~ 240V	380 ~ 440V	500 ~ 550V	690V			
6A	1.5kW 7A	2.2kW 6A	3kW 5A	3kW 4A	20A	1NO or 1NC	CGMC-6A
9A	2.2kW 9A	4kW 9A	3.7kW 6A	4kW 5A	20A	1NO or 1NC	CGMC-9A
12A	3kW 12A	5.5kW 12A	4kW 7A	4kW 5A	20A	1NO or 1NC	CGMC-12A



Solder pin connection types

Frame size	AC3 ratings (IEC60947-4)				AC1 rating Ith	Auxiliary contact (standard)	Type
	220 ~ 240V	380 ~ 440V	500 ~ 550V	690V			
6A	1.5kW 7A	2.2kW 6A	3kW 5A	3kW 4A	20A	1NO or 1NC	CGMP-6A
9A	2.2kW 9A	4kW 9A	3.7kW 6A	4kW 5A	20A	1NO or 1NC	CGMP-9A
12A	3kW 12A	5.5kW 12A	4kW 7A	4kW 5A	20A	1NO or 1NC	CGMP-12A

Coil voltage, AC 50/60Hz

24, 36, 42, 48, 110, 115, 120, 127, 200 / 208, 220, 220 / 230, 230 / 240, 256, 277, 380 / 400
400, 440, 480, 500, 550V AC

Ordering information

Type, Auxiliary contact and Coil voltage

For more information

- Drawings → page 34
- Reversing contactors → page 23
- Overload relays → page 27
- Optional accessories → page 29~33

Certificate
CE, ULcUL

Contactors

- For motor control
- 3 main plus 1 auxiliary contacts
- Coil voltage : D.C.



Cage clamp connection types

Frame size	AC3 ratings (IEC60947-4)				AC1 rating Ith	Auxiliary contact (standard)	Type
	220 ~ 240V	380 ~ 440V	500 ~ 550V	690V			
6A	1.5kW 7A	2.2kW 6A	3kW 5A	3kW 4A	20A	1NO or 1NC	CGMC-6D
9A	2.2kW 9A	4kW 9A	3.7kW 6A	4kW 5A	20A	1NO or 1NC	CGMC-9D
12A	3kW 12A	5.5kW 12A	4kW 7A	4kW 5A	20A	1NO or 1NC	CGMC-12D



Solder pin connection types

Frame size	AC3 ratings (IEC60947-4)				AC1 rating Ith	Auxiliary contact (standard)	Type
	220 ~ 240V	380 ~ 440V	500 ~ 550V	690V			
6A	1.5kW 7A	2.2kW 6A	3kW 5A	3kW 4A	20A	1NO or 1NC	CGMP-6D
9A	2.2kW 9A	4kW 9A	3.7kW 6A	4kW 5A	20A	1NO or 1NC	CGMP-9D
12A	3kW 12A	5.5kW 12A	4kW 7A	4kW 5A	20A	1NO or 1NC	CGMP-12D

Coil voltage, DC

- ① Standard type : 12, 20, 24, 36, 42, 48, 60, 72, 110, 120, 125, 220, 240, 250V DC
- ② Low consumption type : 12, 20, 24, 48, 72, 110, 120V DC(Low)
- ③ Wide Voltage : 12, 20, 24, 48, 72, 110, 12V DC(Wide)

Ordering information

Type, Auxiliary contact and Coil voltage

For more information

- Drawings → page 34
- Reversing contactors → page 25
- Overload relays → page 27
- Optional accessories → page 29~33

Certificate
CE, ULcUL

Mini contactors

Dimensions

CGMS-12A

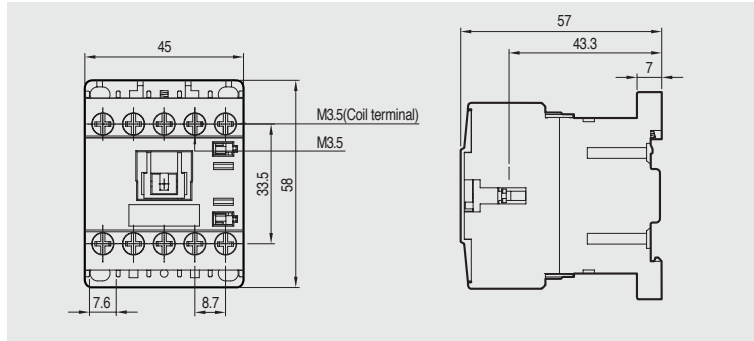

0.17kg

CGMS-12D

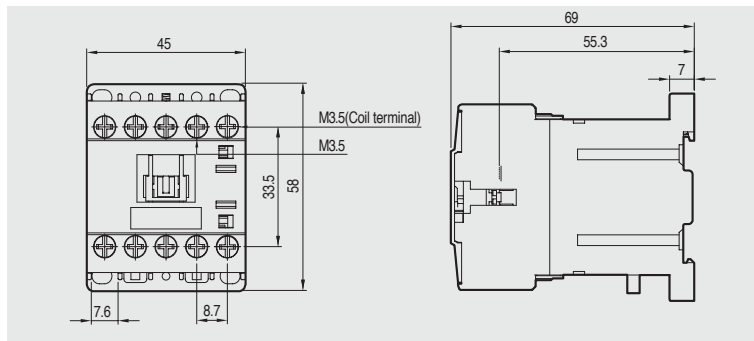

0.23kg

CGMUS-12A

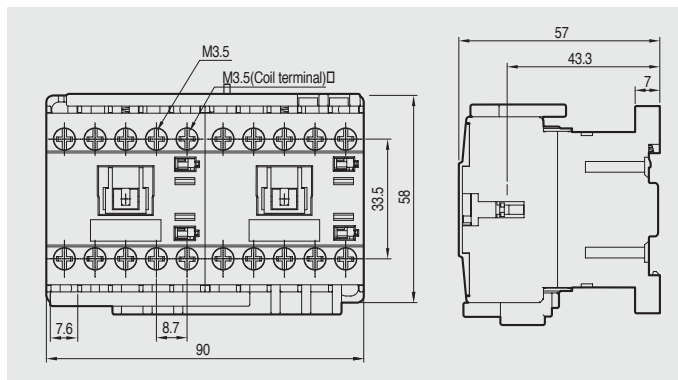

0.36kg

CGMUS-12D

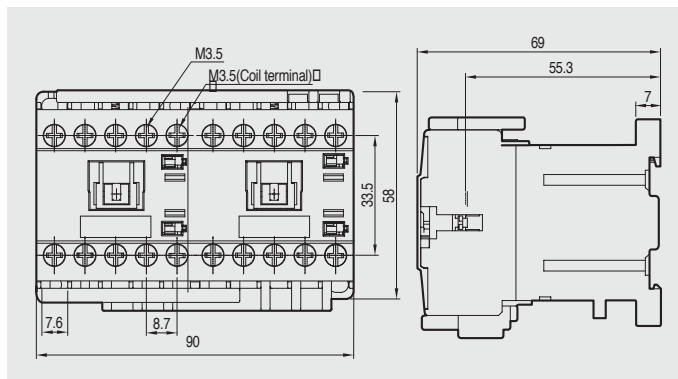

0.48kg