

CGRB201-G Thru. CGRB207-G

Glass Passivated Type
Reverse Voltage: 50 to 1000 Volts
Forward Current: 2.0 Amp
RoHS Device

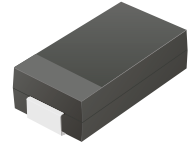

Features

- Ideal for surface mount applications.
- Easy pick and place.
- Plastic package has Underwriters Lab. flammability classification 94V-0.
- Built in strain relief.
- High surge current capability.

Mechanical data

- Case: JEDEC DO-214AA, molded plastic.
- Terminals: solderable per MIL-STD-750, method 2026.
- Polarity: Color band denotes cathode end.
- Approx. weight: 0.093 grams

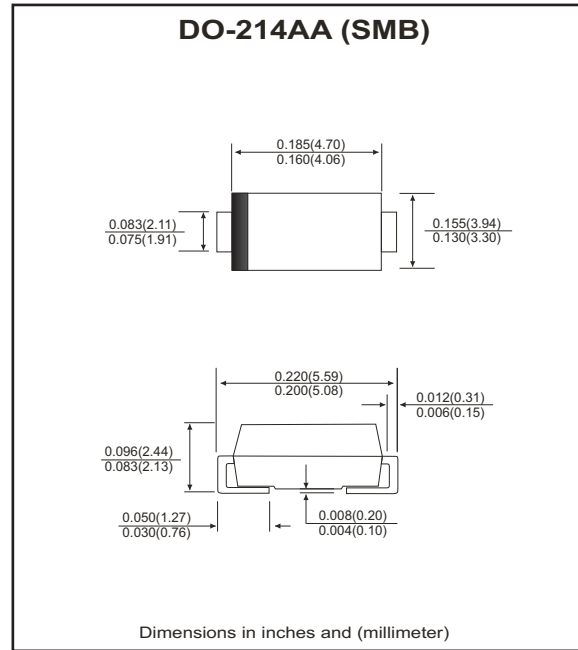

Maximum Ratings and Electrical Characteristics

Parameter	Symbol	CGRB 201-G	CGRB 202-G	CGRB 203-G	CGRB 204-G	CGRB 205-G	CGRB 206-G	CGRB 207-G	Units
Max. repetitive peak reverse voltage	V_{RRM}	50	100	200	400	600	800	1000	V
Max. DC blocking voltage	V_{DC}	50	100	200	400	600	800	1000	V
Max. RMS voltage	V_{RMS}	35	70	140	280	420	560	700	V
Peak surge forward current, 8.3ms single half sine-wave superimposed on rate load (JEDEC method)	I_{FSM}	60							A
Max. average forward current	I_o	2.0							A
Max. instantaneous forward voltage at 2.0A	V_F	1.1							V
Max. DC reverse current at $T_A=25\text{ }^\circ\text{C}$ rated DC blocking voltage $T_A=125\text{ }^\circ\text{C}$	I_R	5.0 100							μA
Max. thermal resistance (Note 1)	$R_{\theta JL}$	16							$^\circ\text{C/W}$
Max. operating junction temperature	T_J	150							$^\circ\text{C}$
Storage temperature	T_{STG}	-55 to +150							$^\circ\text{C}$

Notes: 1. Thermal resistance from junction to lead mounted on P.C.B. with 8.0×8.0 mm square (0.13mm thick) land area.

RATING AND CHARACTERISTIC CURVES (CGRB201-G thru CGRB207-G)

Fig.1 Reverse Characteristics

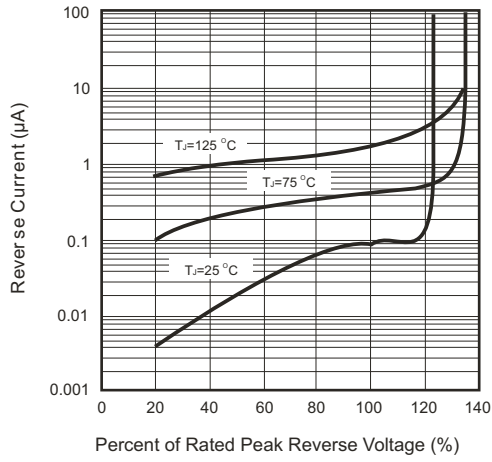

Fig.2 Forward Characteristics

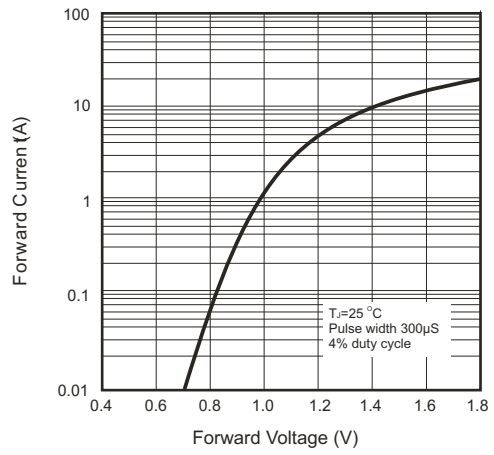

Fig.3 Junction Capacitance

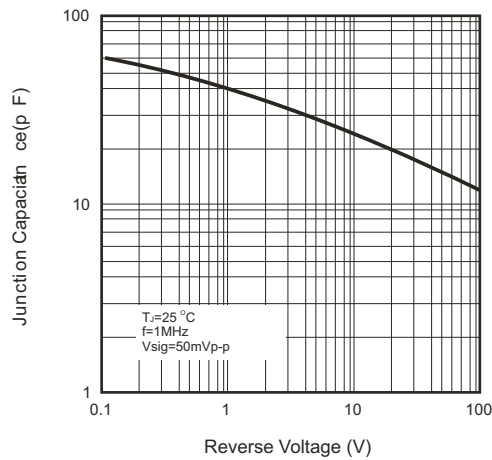

Fig.4 Current Derating Curve

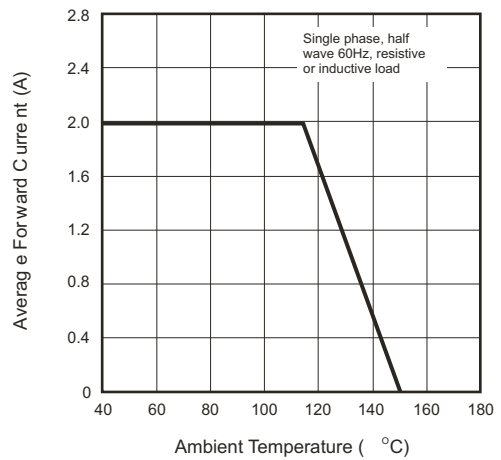
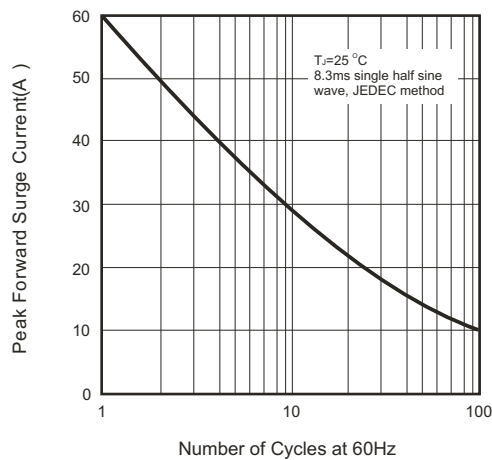
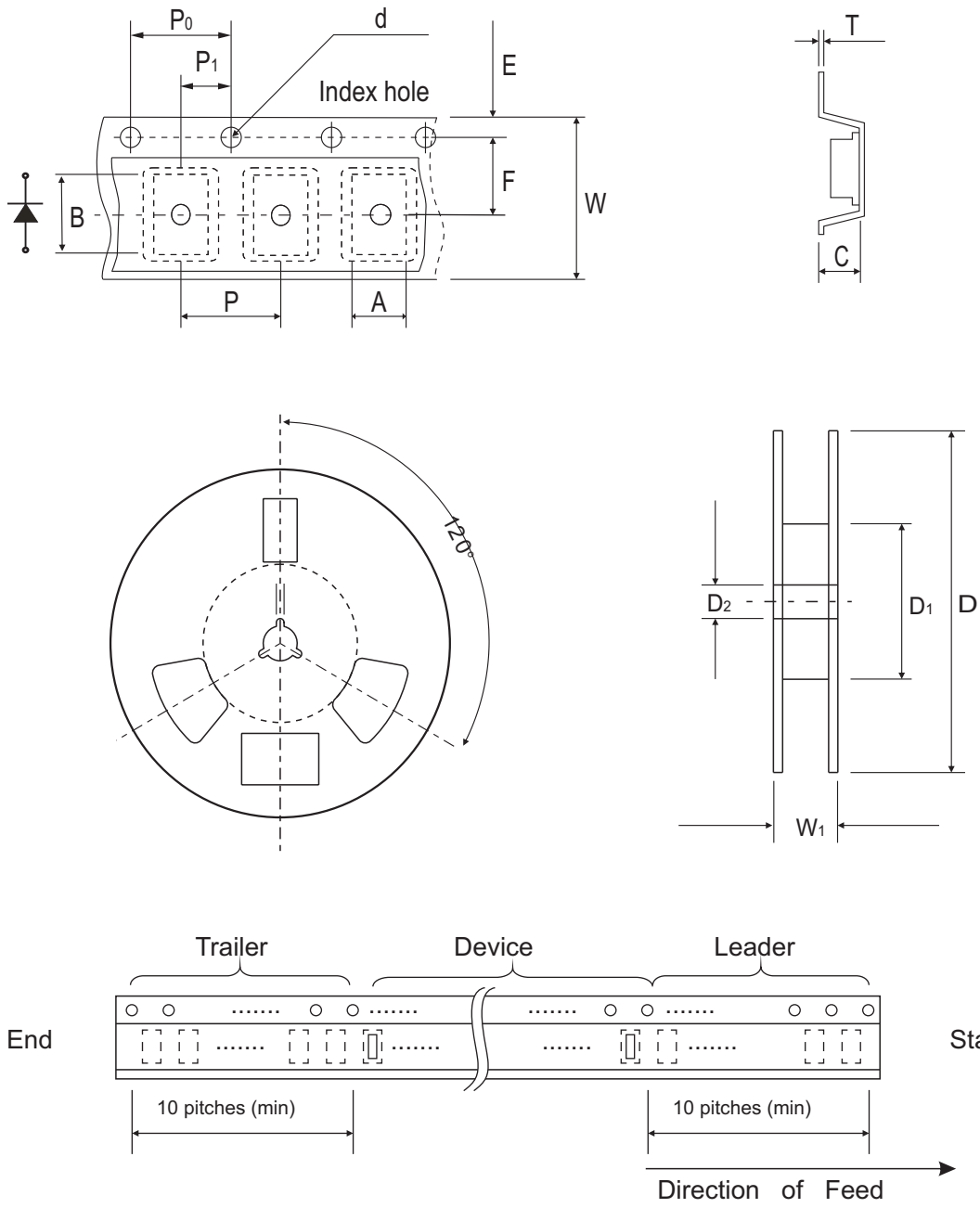

Fig.5 Non-repetitive Forward Surge Current



Reel Taping Specification



DO-214AA (SMB)	SYMBOL	A	B	C	d	D	D1	D2	E
	(mm)	4.00 MAX.	5.90 MAX.	3.00 MAX.	1.50 ± 0.10 _{DIA}	330 ± 2.00	50.0 MIN.	13.50 ± 1.0	1.75 ± 0.1
	(inch)	0.157 MAX.	0.232 MAX.	0.118 MAX.	0.059 ± 0.004 _{DIA}	12.99 ± 0.079	1.969 MIN.	0.531 ± 0.039	0.069 ± 0.004

DO-214AA (SMB)	SYMBOL	F	P	P0	P1	T	W	W1	W2
	(mm)	5.50 ± 0.05	8.00 ± 0.10	4.00 ± 0.10	2.00 ± 0.05	0.60 MAX	12.0 ± 0.30	18.4 MAX.	14.4 MAX.
	(inch)	0.217 ± 0.002	0.315 ± 0.004	0.157 ± 0.004	0.079 ± 0.004	0.236 ± 0.004	0.472 ± 0.012	0.724 MAX	0.566 MAX