

		REVISION	
REV	DESCRIPTION		DATE
G	REVISED PER ECO-18-008206		29MAY2018

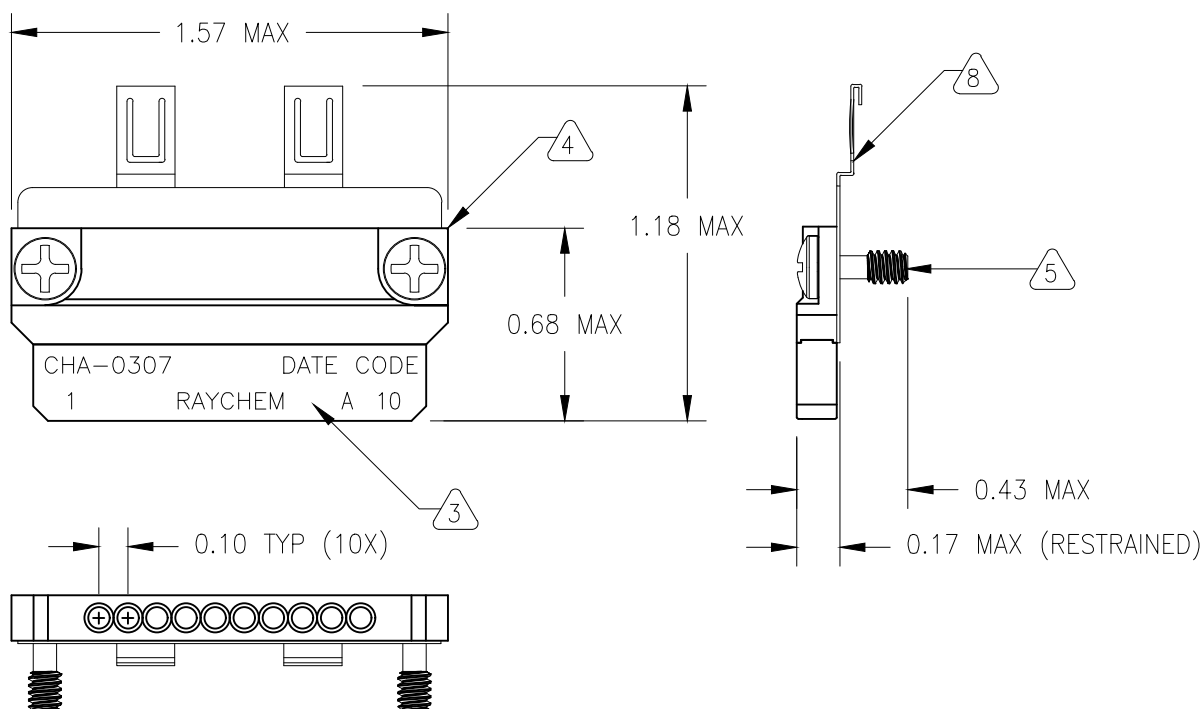

Notes:

1. Application: Electroless Nickel MTC SH1 Plug Shells
2. For Use With MIL-C 39029/58-360, Size 22 Contacts
3. End Cap: Glass Filled Nylon, Flame Retardant, Black
4. Main Body: Aluminum, Electroless Nickel Plated
5. Screws: 4-40 Phillips Head, Stainless Steel 302, Passivated, Captive, Self-Locking. Alternative material A-286
6. Electrical Contacts: Brass / Beryllium Copper, Gold Plated
7. Markings: High Contrast Ink
8. Bus Bar, Beryllium Copper, Electroless Nickel Plated
9. Meets Raychem Specification C-6114 Requirements
10. Contact Cavity Bore Dia, Plated: .0685/0690 (REF)

© 2004 TYCO ELECTRONICS CORPORATION. ALL RIGHTS RESERVED.

				SPECIFICATION CONTROL DRAWING		
UNLESS OTHERWISE SPECIFIED DIMENSIONS ARE INCHES. METRIC DIMENSIONS ARE IN BRACKETS.		DRAWN T RATZLAFF	DATE 26MAR2004	tyco Electronics	TYCO ELECTRONICS 300 CONSTITUTION DRIVE MENLO PARK, CA 94025	Raychem
DECIMAL TOLERANCES .XXX ± 0.005 [0.13 mm] .XX ± 0.010 [0.25 mm] .X ± 0.020 [0.50 mm]		SEE NOTES		TITLE 1-INCH MTC GROUNDING BLOCK WITH FINGERS		
ANGLE TOLERANCE .X ± 0.5 DEG.		SEE NOTES				
WEIGHT (NOM) LBS. 0.0137 [6.2 gm]		THIRD ANGLE PROJECTION		SIZE A	CAGE CODE 06090	DWG. NO. CHA-0307
CAD FILE C041089.DWG				DO NOT SCALE THIS DRAWING		SHEET 1 OF 1