

### Features

- ▶ Low phase error
- ▶ Low insertion loss
- ▶ 360° phase shift, LSB = 11.25°
- ▶ Single bit negative logic
- ▶ Pb-free RoHs compliant 4x4 QFN package

### Description

The CMD175P4 is a GaAs MMIC 5-bit phase shifter housed in a leadless 4x4 mm plastic surface mount package. The CMD175P4 operates from 2 to 4 GHz and provides 0 to 360 degrees of monotonic phase coverage, with a LSB of 11.25 degrees. The device is controlled with single bit negative logic of 0 or -3 V and features an insertion loss of 7 dB and a phase error of  $\pm 5$  degrees. The CMD175P4 is a 50 ohm matched design which eliminates the need for external DC blocks and RF port matching.

### Functional Block Diagram

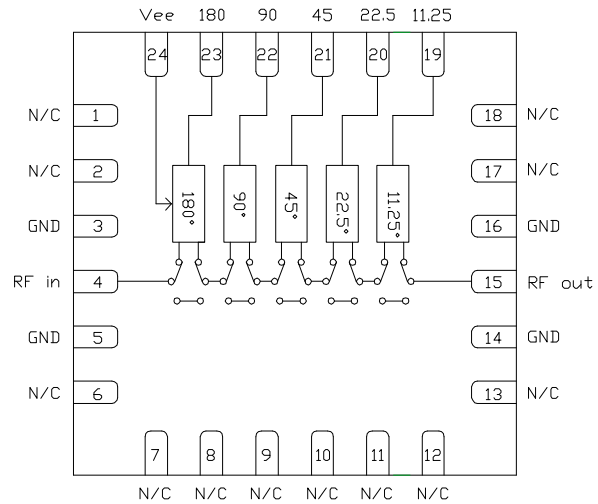

### Electrical Performance - $V_{ee} = -3$ V, $V_{ctl} = 0/-3$ V, $T_A = 25$ °C, $F = 3$ GHz

Parameter	Min	Typ	Max	Units
Frequency Range	2 - 4			GHz
Insertion Loss		7		dB
Input Return Loss		18		dB
Output Return Loss		17		dB
Phase Error		+1 / -8		deg
Input P1dB		24		dBm
Input IP3		37		dBm
Supply Current		4		mA



# CMD175P4

## 2-4 GHz 5-Bit Digital Phase Shifter

### Specifications

#### Absolute Maximum Ratings

Parameter	Rating
Supply Voltage, V <sub>ee</sub>	-8.0 V
RF Input Power	+30 dBm
Operating Temperature	-40 to 85 °C
Storage Temperature	-55 to 150 °C

Exceeding any one or combination of the maximum ratings may cause permanent damage to the device.

#### Recommended Operating Conditions

Parameter	Min	Typ	Max	Units
V <sub>ee</sub>	-5.0		-3.0	V
I <sub>ee</sub>		4		mA

Electrical performance is measured at specific test conditions. Electrical specifications are not guaranteed over all recommended operating conditions.

#### Truth Table

Control Voltage Input					Phase Shift (degrees)
11.25	22.5	45	90	180	
High	High	High	High	High	Reference
Low	High	High	High	High	11.25
High	Low	High	High	High	22.5
High	High	Low	High	High	45
High	High	High	Low	High	90
High	High	High	High	Low	180
Low	Low	Low	Low	Low	348.75

#### Control Voltage

State	Bias Condition
High	V <sub>ee</sub> ± 0.3 V
Low	0 ± 0.3 V

ver 1.4 0518



# CMD175P4

## 2-4 GHz 5-Bit Digital Phase Shifter

### Specifications

Electrical Specifications -  $V_{ce} = -3.0$  V,  $V_{ctl} = 0/-3$  V,  $T_A = 25$  °C

Parameter	Min	Typ	Max	Min	Typ	Max	Units
Frequency Range	2 - 3			3 - 4			GHz
Insertion Loss		7.5	10		7	8.5	dB
Input Return Loss		15			15		dB
Output Return Loss		17			17		dB
Phase Error		± 8	± 12		+4 / -8	+7 / -12	deg
Insertion Loss Variation		± 0.5			± 0.5		dB
Input P1dB		24			25		dBm
Input IP3		36			37		dBm
Supply Current		4			4		mA

Note: Specification applies to major states

ver 1.4 0518

### Typical Performance

Insertion Loss, Major States,  $V_{ee} = -3.0\text{ V}$ ,  $T_A = 25\text{ }^\circ\text{C}$

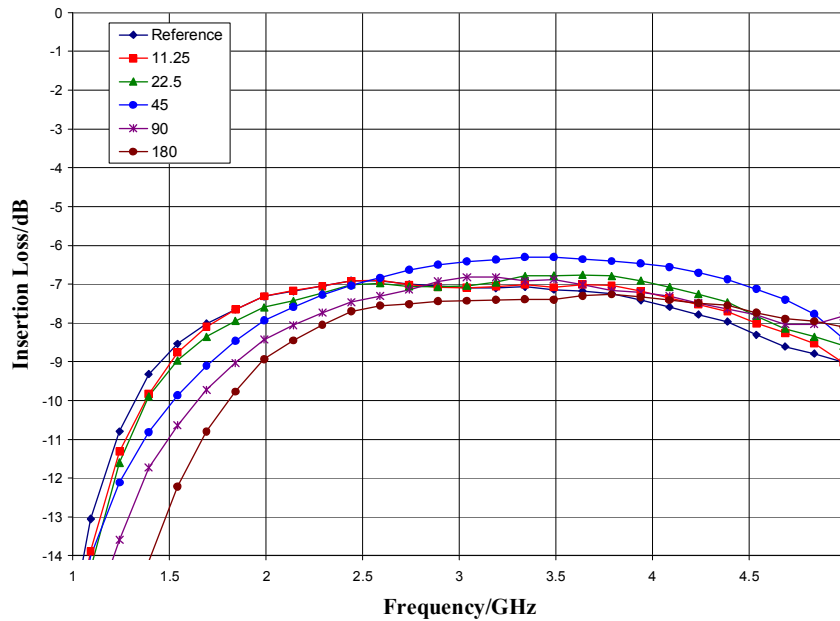

Relative Phase Shift, Major States and All On State,  $V_{ee} = -3.0\text{ V}$ ,  $T_A = 25\text{ }^\circ\text{C}$

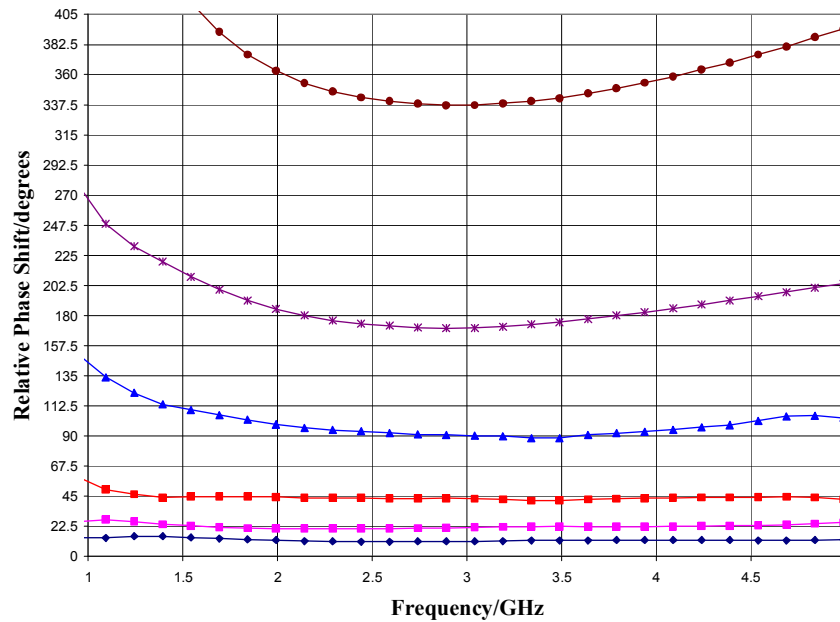

ver 1.4 0518

### Typical Performance

Input Return Loss, Major States,  $V_{cc} = -3.0\text{ V}$ ,  $T_A = 25\text{ }^\circ\text{C}$

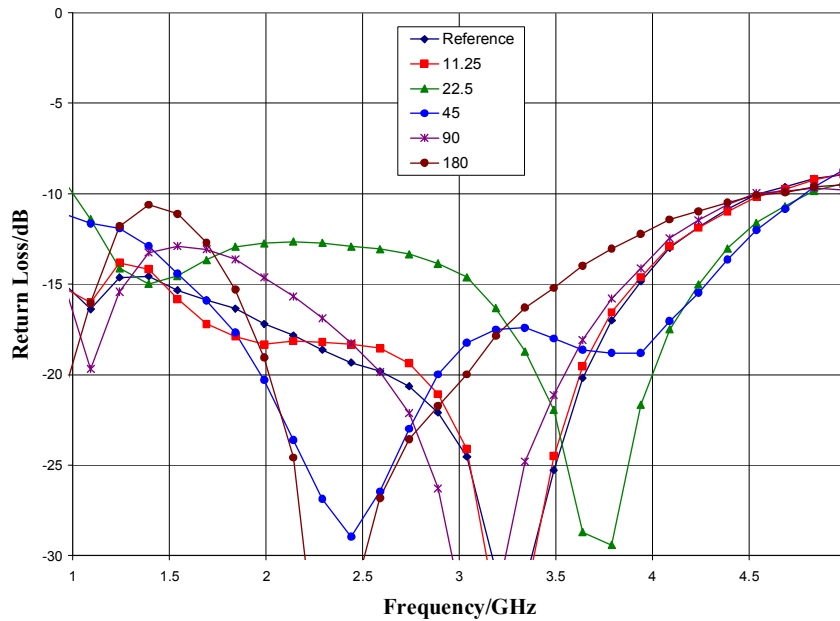

Output Return Loss, Major States,  $V_{cc} = -3.0\text{ V}$ ,  $T_A = 25\text{ }^\circ\text{C}$

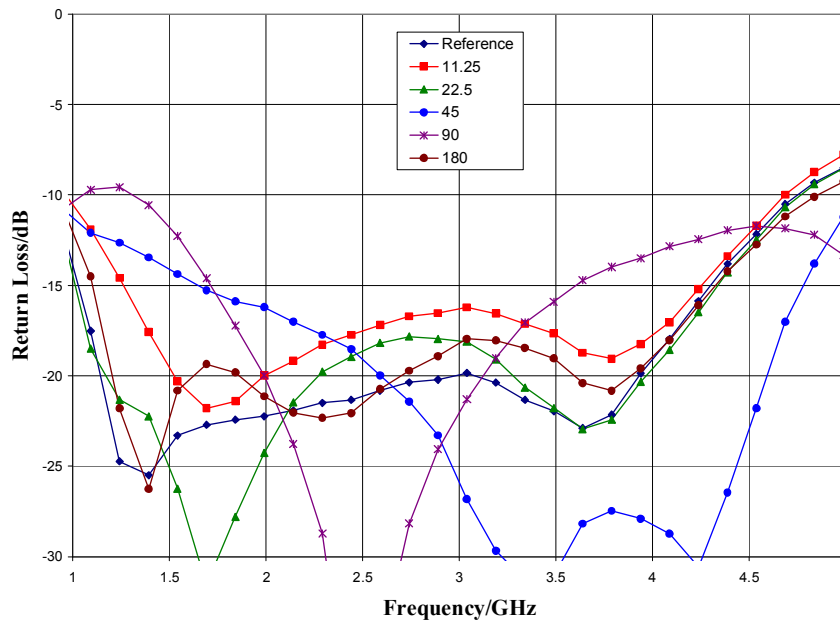

ver 1.4 0518

### Typical Performance

Normalized Loss, Major States,  $V_{ee} = -3.0$  V

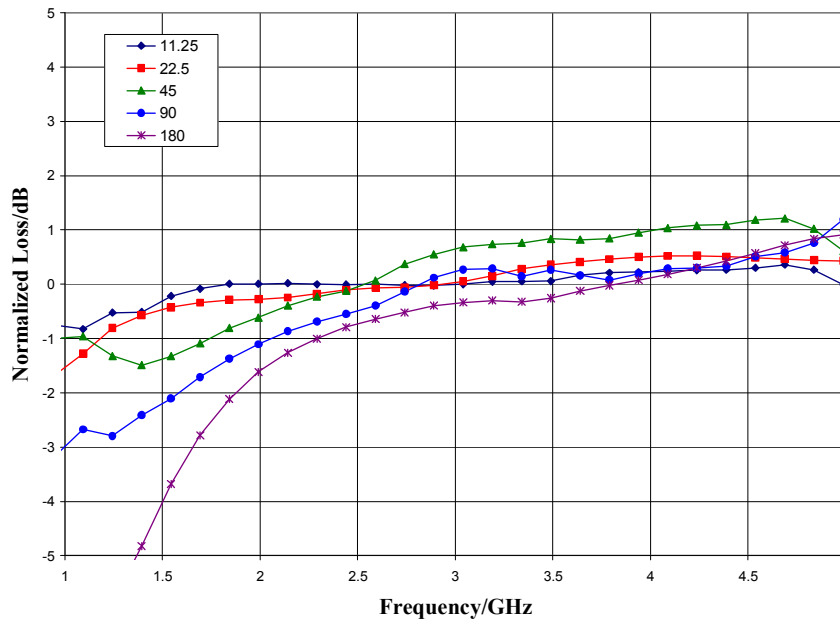

Phase Error, Major States and All On State,  $V_{ee} = -3.0$  V

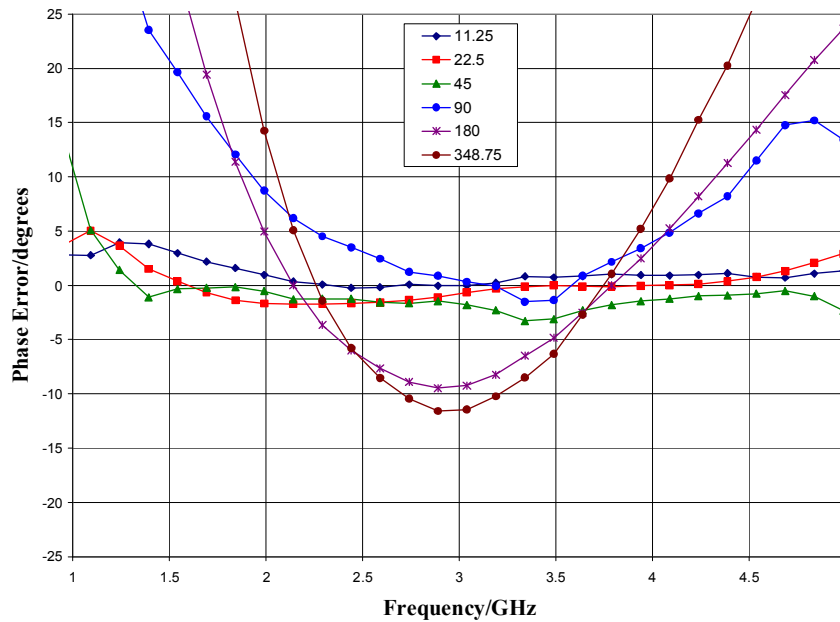

ver 1.4 0518

### Typical Performance

#### Insertion Loss vs. Temperature, Reference State, $V_{ee} = -3.0$ V

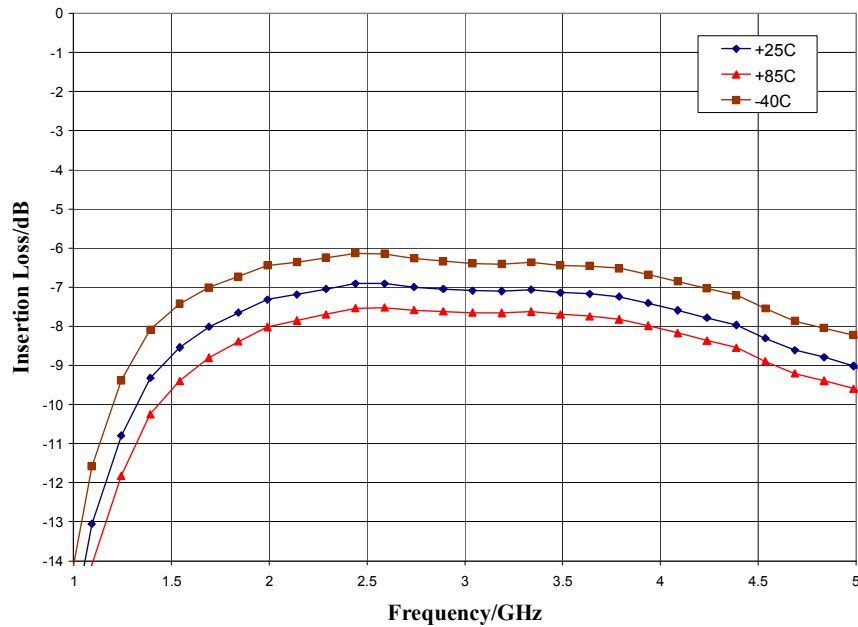

#### Input P1dB, $V_{ee} = -3.0$ V

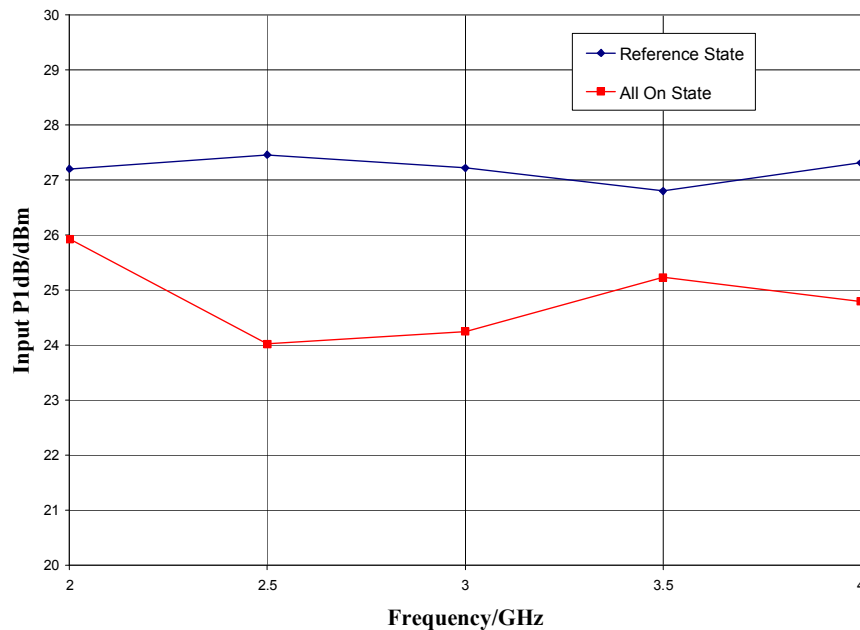

ver 1.4 0518

### Typical Performance

Input IP3,  $V_{ee} = -3.0$  V

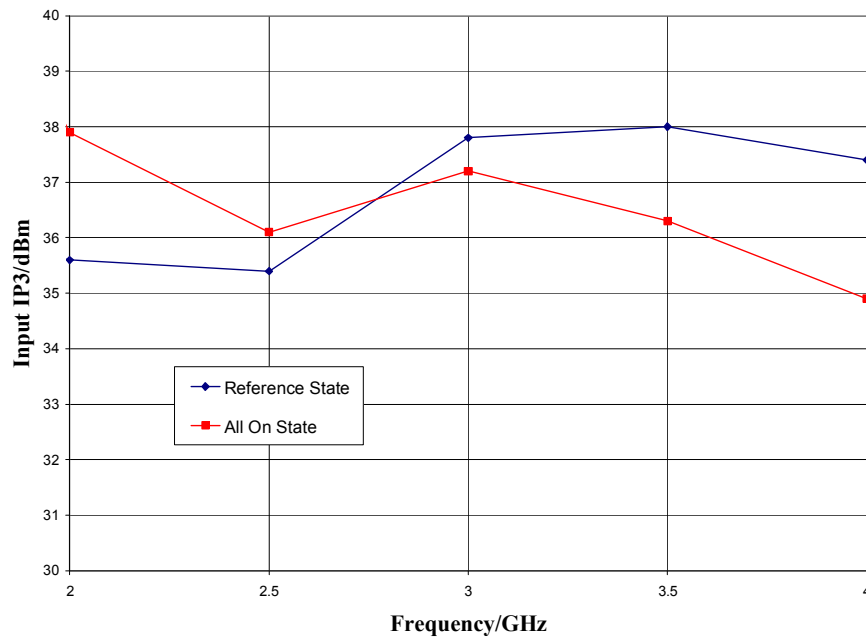



### Mechanical Information

#### Package Information and Dimensions

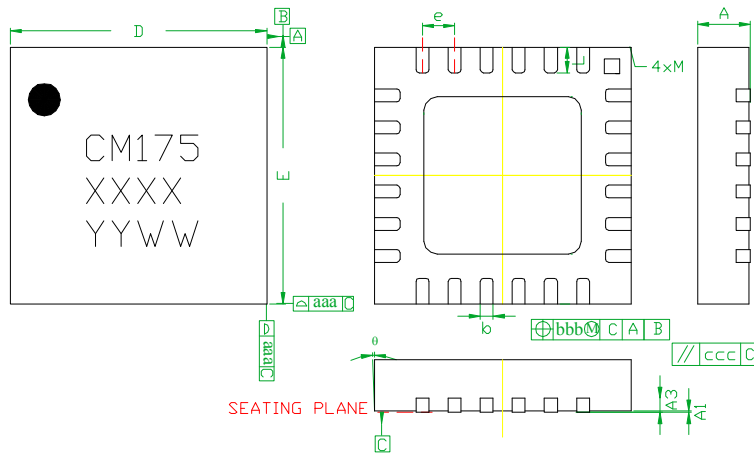

SYMBOLS	DIMENSIONS IN MILLIMETERS		
	MIN	NOM	MAX
A	0.80	0.90	1.00
A1	0	0.02	0.05
A3	—	0.25REF.	—
b	0.18	0.23	0.30
D	3.85	4.00	4.15
D1	—	2.45BSC	—
E	3.85	4.00	4.15
E1	—	2.45BSC	—
e	—	0.50BSC	—
L	0.30	0.40	0.50
θ	0	—	12
aaa	—	0.25	—
bbb	—	0.10	—
ccc	—	0.10	—
M	—	—	0.05

**NOTES:**

1. DIMENSIONS ARE IN MILLIMETERS
2. RoHS COMPLIANT MOLD COMPOUND
3. LEADFRAME MATERIAL: COPPER ALLOY
4. LEAD FINISH: 100% MATTE Sn
5. INDICATED DIMENSION/TOLERANCE APPLIES TO LEADS AND EXPOSED PAD

#### Recommended PCB Land Pattern

Custom MMIC Design Services recommends that the user develop the land pattern that will provide the best design for proper solder reflow and device attach for their specific application. Please review CMDS Application Note AN 105 for a recommended land pattern approach.

#### Recommended Solder Reflow Profile

Custom MMIC Design Services recommends screen printing with belt furnace reflow to ensure proper solder reflow and device attach. Please review CMDS Application Note AN 102 for a recommended solder reflow profile.



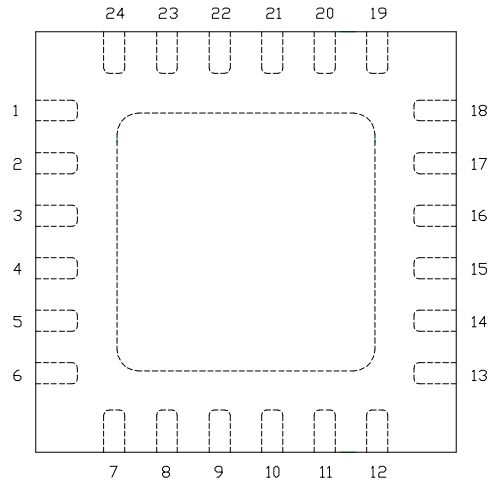

**GaAs MMIC devices are susceptible to damage from Electrostatic Discharge. Proper precautions should be observed during handling, assembly and test.**

### Pin Description

#### Pin Diagram

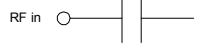

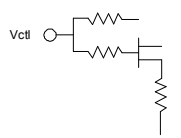
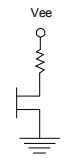
#### Functional Description

Pad	Function	Description	Schematic
1, 2, 6-13, 17, 18	N/C	No connection required. These pins may be connected to RF / DC ground	
4	RF in	DC blocked and 50 ohm matched	RF in 
15	RF out	DC blocked and 50 ohm matched	 RF out
19	11.25	11.25° control input	
20	22.5	22.5° control input	
21	45	45° control input	
22	90	90° control input	
23	180	180° control input	
24	Vee	Supply Voltage	
3,5,14,16 and die paddle	Ground	Connect to RF / DC ground	

ver 1.4 0518