

### Features

- ▶ Low conversion loss
- ▶ High isolation
- ▶ Wide IF bandwidth
- ▶ Passive double balanced topology
- ▶ Pb-free RoHs compliant 3x3 mm SMT package

### Description

The CMD178C3 is a general purpose double balanced mixer in a leadless surface mount package that can be used for up- and downconverting applications between 11 and 20 GHz. The CMD178C3 has very high isolation to both the RF and IF ports due to the optimized balun structures, and can operate with an LO drive level as low as +9 dBm. The CMD178C3 can easily be configured as an image reject mixer or single sideband modulator with external hybrids and power splitters.

### Functional Block Diagram

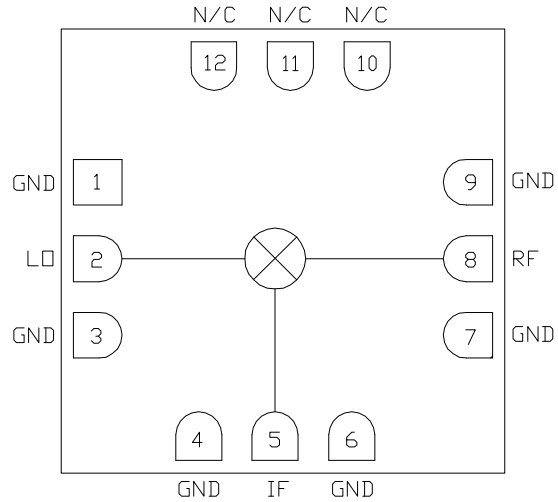

### Electrical Performance - IF = 100 MHz, LO = +13 dBm, T<sub>A</sub> = 25 °C, F = 15 GHz

Parameter	Min	Typ	Max	Units
Frequency Range, RF & LO	11 - 21			GHz
Frequency Range, IF	DC		6	GHz
Conversion Loss		6		dB
LO to RF Isolation		45		dB
LO to IF Isolation		45		dB
RF to IF Isolation		26		dB
Input P1dB		9		dBm

Unless otherwise noted, all measurements performed as a downconverter, IF = 100 MHz



# CMD178C3

## 11-21 GHz Fundamental Mixer

### Specifications

#### Absolute Maximum Ratings

Parameter	Rating
RF / IF Input Power	+25 dBm
LO Drive	+25 dBm
Operating Temperature	-40 to 85 °C
Storage Temperature	-55 to 150 °C

Operation of this device outside the maximum ratings may cause permanent damage.

#### Electrical Specifications - IF = 100 MHz, LO = +13 dBm, T<sub>A</sub> = 25 °C

Parameter	Min	Typ	Max	Min	Typ	Max	Units
Frequency Range, RF & LO	13 - 17			11 - 21			GHz
Frequency Range, IF	DC		6	DC		6	GHz
Conversion Loss		6	8		7	10	dB
Noise Figure (SSB)		6	8		7	10	dB
LO to RF Isolation	35	43		31	43		dB
LO to IF Isolation	33	48		30	38		dB
RF to IF Isolation	17	25		15	25		dB
Input P1dB		9			9		dBm
Input IP3		16			16		dBm

Unless otherwise noted, all measurements performed as a downconverter, IF = 100 MHz

ver 1.5 1017

### Typical Performance

Conversion Gain vs. Temperature, LO = +13 dBm, IF = 100 MHz USB

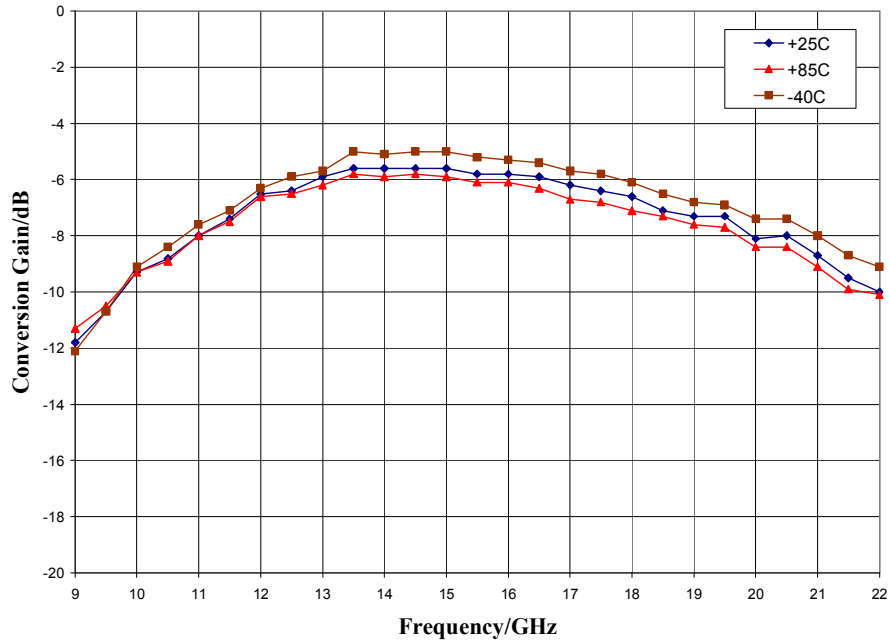

Isolation, LO = +13 dBm

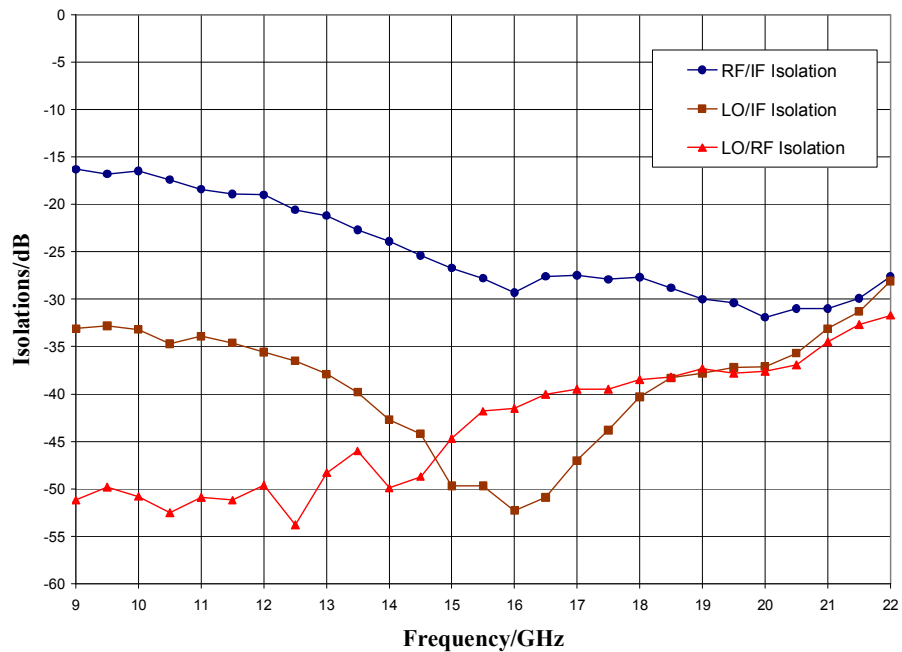

ver 1.5 1017

### Typical Performance

#### Conversion Gain vs. LO Drive, IF = 100 MHz USB

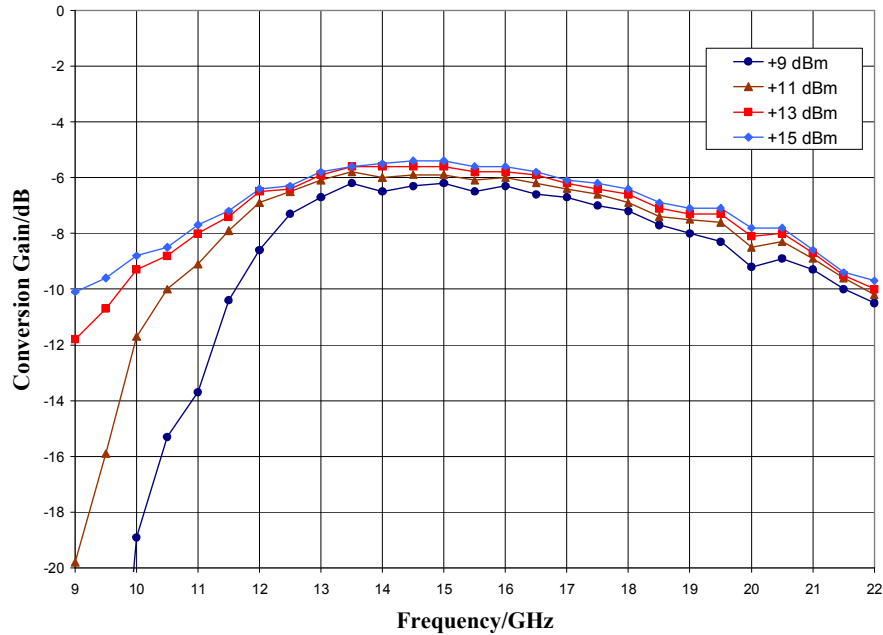

#### Return Loss, LO = + 13 dBm

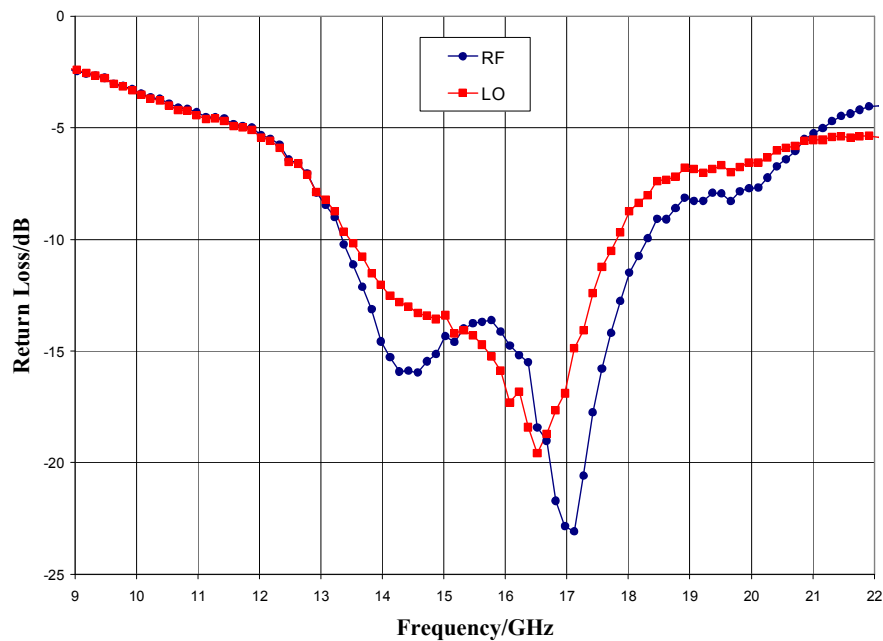

ver 1.5 1017

### Typical Performance

**IF Bandwidth, LO = +13 dBm**

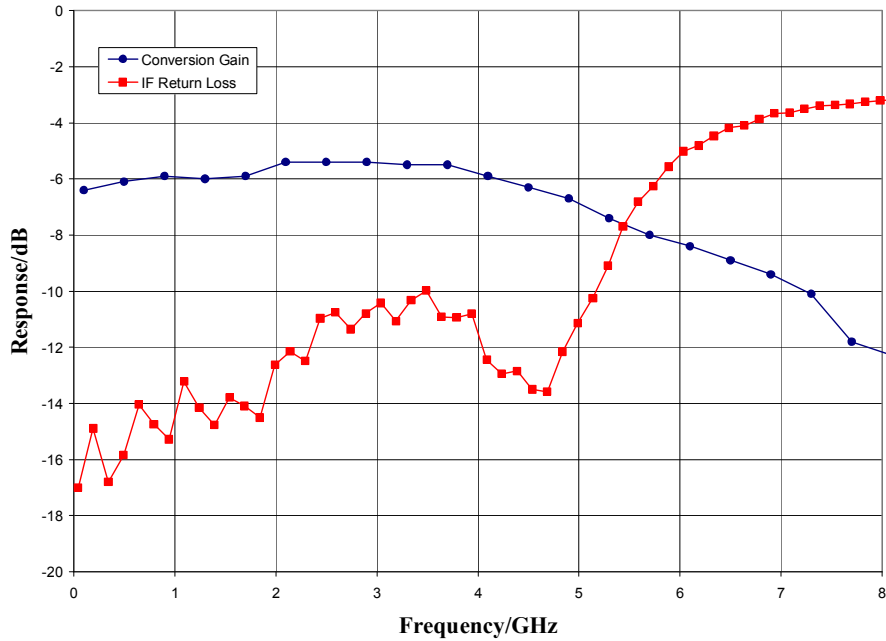

**Upconverter Performance, Conversion Gain vs. LO Drive, IF input = 100 MHz**

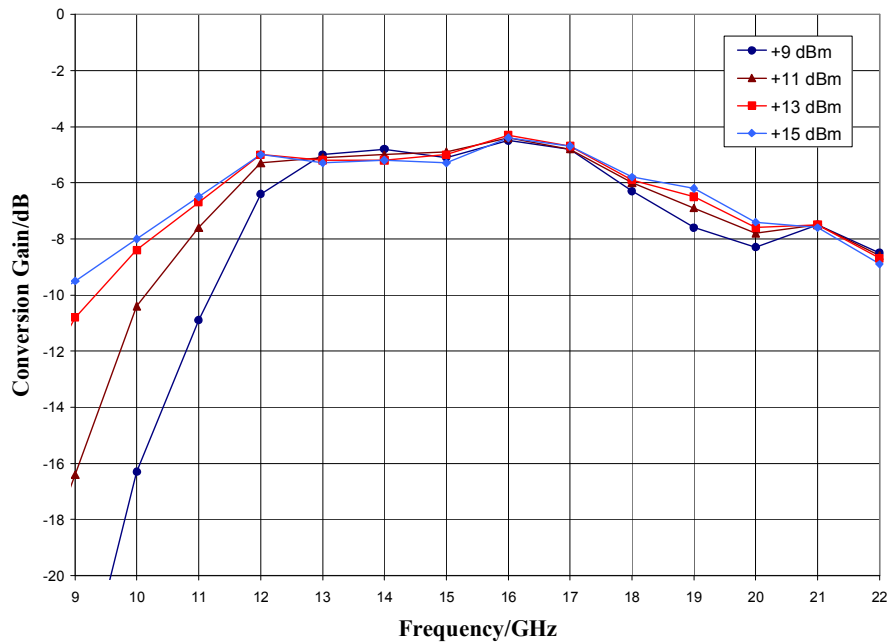

ver 1.5 1017

### Typical Performance

**Input IP3 vs. Temperature, LO = +13 dBm, IF = 100 MHz**

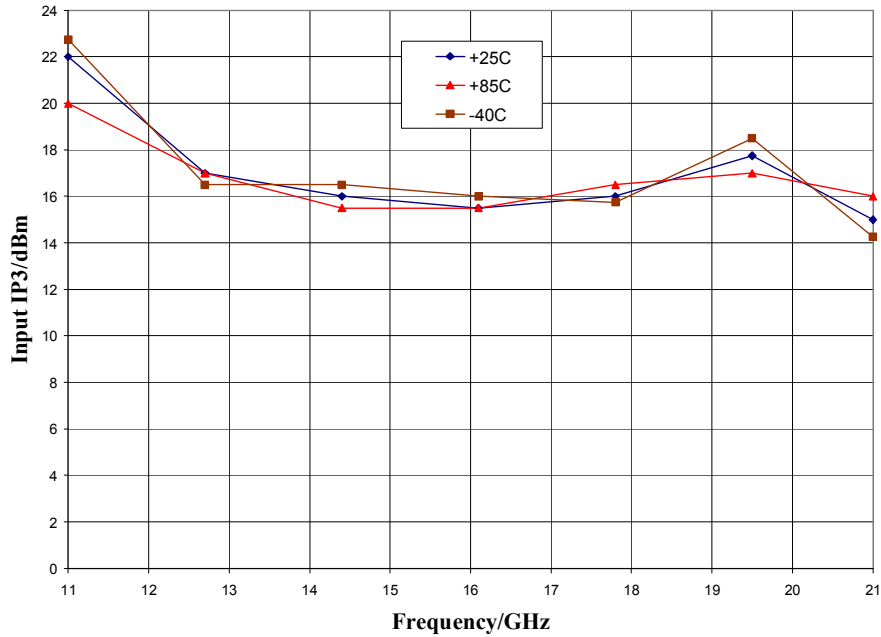

**Input IP3 vs. LO Drive, IF = 100 MHz**

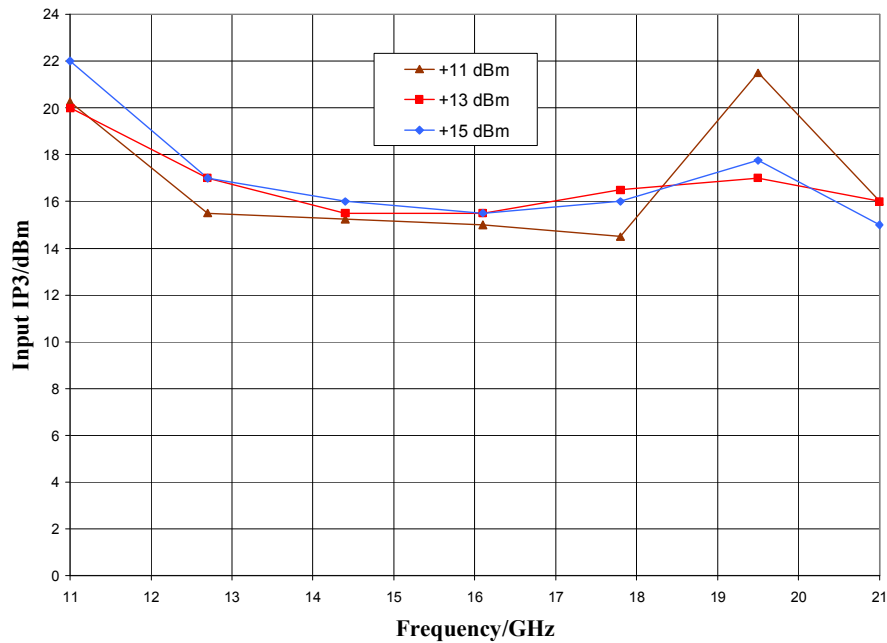

ver 1.5 1017

### Typical Performance

#### Upconverter Performance, Input IP3 vs. LO Drive, IF = 500 MHz

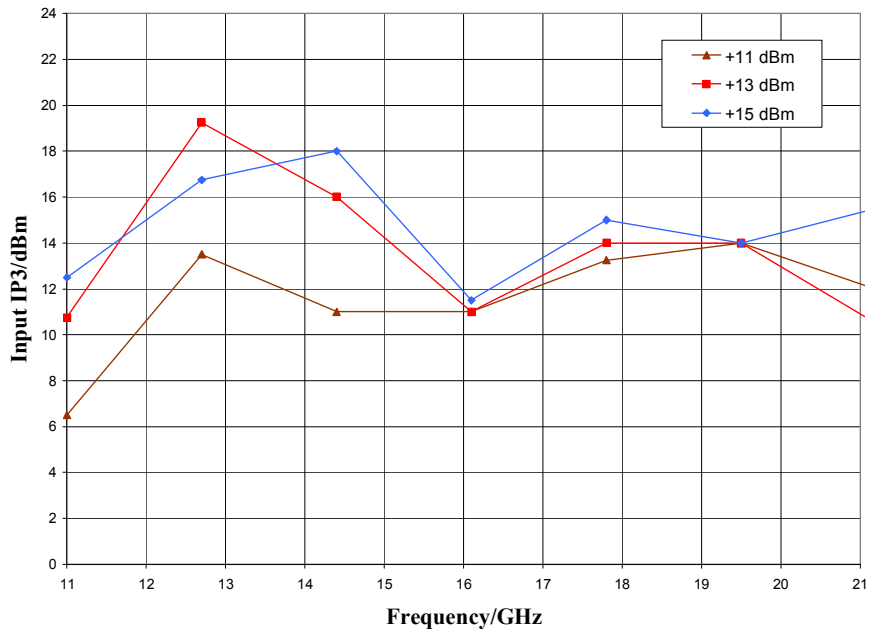

#### Input P1dB vs. Temperature, LO = +13 dBm, IF = 100 MHz USB

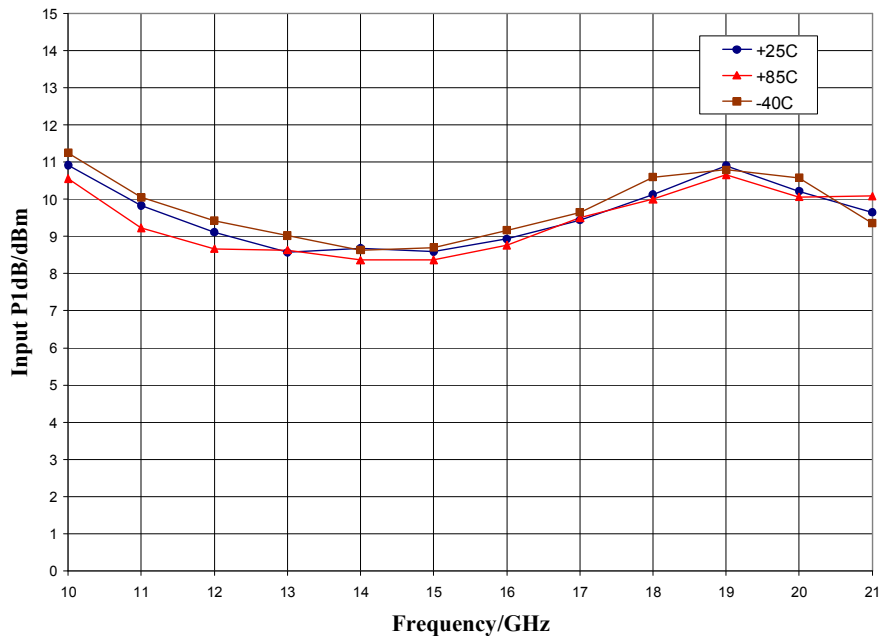

ver 1.5 1017

### Typical Performance

#### MxN Spurious Outputs

mRF	nLO				
	0	1	2	3	4
0	xx	25	33	> 90	> 90
1	28	0	47	40	> 90
2	72	64	64	67	75
3	> 90	> 90	> 90	64	> 90
4	> 90	> 90	> 90	> 90	> 90

RF = 15.1 GHz @ -10 dBm  
 LO = 15.0 GHz @ +13 dBm  
 All values in dBc below the IF output power level (1RF - 1LO)



### Mechanical Information

#### Package Information and Dimensions

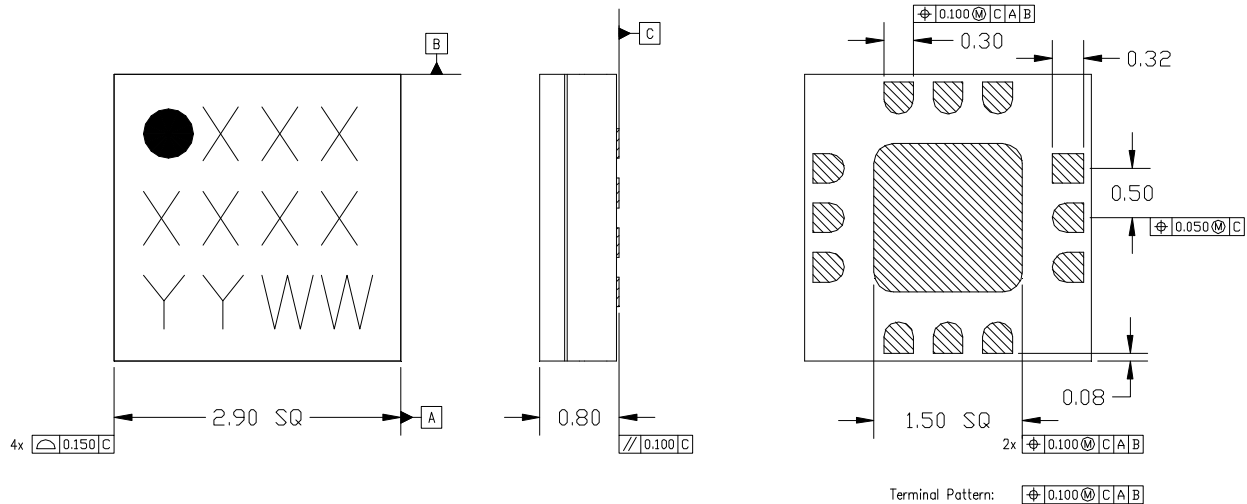

#### NOTES:

1. ALL DIMENSIONS SHOWN IN mm.
2. MATERIAL: BLACK ALUMINA
3. LEAD FINISH:
  - 3.1. Ni: 8.89 $\mu$ m MAX, 1.27 $\mu$ m MIN
  - 3.2. Pd: 0.17 $\mu$ m MAX, 0.07 $\mu$ m MIN
  - 3.3. Au: 0.254 $\mu$ m MAX, 0.03 $\mu$ m MIN
4. MARKING
  - 4.1. LINE 1: PART NUMBER
    - 4.1.1. EXAMPLE: CMD177C3 SHALL BE MARKED AS 177
  - 4.2. LINE 2: LDT NUMBER
  - 4.3. LINE 3: DATE CODE - LAST 2 DIGITS OF THE YEAR OF MANUFACTURE FOLLOWED BY A 2 DIGIT WEEK CODE
5. ALTERNATE PIN #1 IDENTIFIER IS A SINGLE SQUARE PAD
6. ALTERNATE DIE PADDLE MAY HAVE CHAMFERED CORNERS

#### Recommended PCB Land Pattern

Custom MMIC Design Services recommends that the user develop the land pattern that will provide the best design for proper solder reflow and device attach for their specific application. Please review Custom MMIC Application Note AN 105 for a recommended land pattern approach.

#### Recommended Solder Reflow Profile

Custom MMIC Design Services recommends screen printing with belt furnace reflow to ensure proper solder reflow and device attach. Please review Custom MMIC Application Note AN 102 for a recommended solder reflow profile.

### Pin Description

#### Pin Diagram

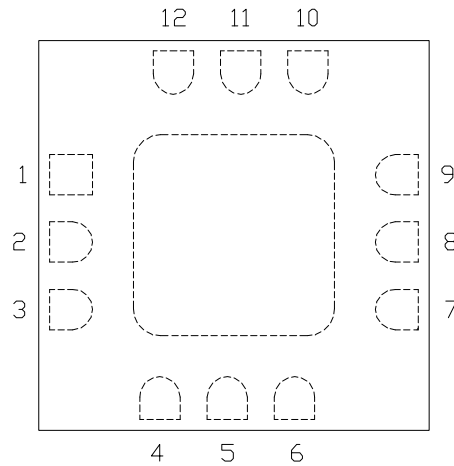

#### Functional Description

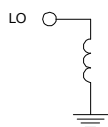
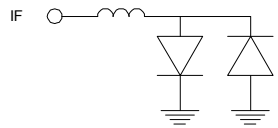
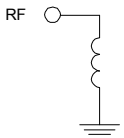
Pin	Function	Description	Schematic
1,3,4,6,7,9 and die paddle	Ground	Connect to RF / DC ground.	
2	LO	This pin is DC coupled and matched to 50 ohms.	
5	IF	This pin is DC coupled. For applications not requiring operation to DC, this port should be DC blocked externally using a series capacitor whose value has been chosen to pass the necessary IF frequency range. For operation to DC, this pin must not source or sink more than 16 mA of current or part non-function or part failure may result.	
8	RF	This pin is DC coupled and matched to 50 ohms.	
10-12	N/C	No connection required. These pins may be connected to RF/DC ground	

ver 1.5 1017