

### Features

- ▶ Low conversion loss
- ▶ High isolation
- ▶ Wide IF bandwidth
- ▶ Passive double balanced topology
- ▶ Pb-free RoHs compliant 3x3 mm SMT package

### Description

The CMD180C3 is a general purpose double balanced mixer in a leadless surface mount package that can be used for up- and downconverting applications between 20 and 32 GHz. The CMD180C3 has very high isolation to both the RF and IF ports due to the optimized balun structures, and can operate with an LO drive level as low as +9 dBm. The CMD180C3 can easily be configured as an image reject mixer or single sideband modulator with external hybrids and power splitters.

### Functional Block Diagram

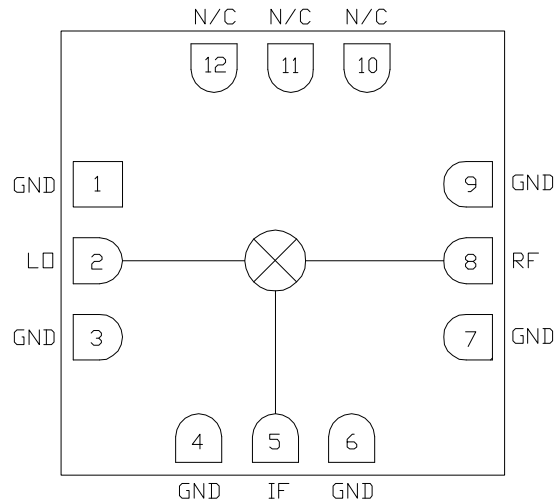

### Electrical Performance - IF = 100 MHz, LO = +13 dBm, T<sub>A</sub> = 25 °C, F = 26 GHz

Parameter	Min	Typ	Max	Units
Frequency Range, RF & LO	20 - 32			GHz
Frequency Range, IF	DC		10	GHz
Conversion Loss		7		dB
LO to RF Isolation		36		dB
LO to IF Isolation		36		dB
RF to IF Isolation		26		dB
Input P1dB		10		dBm

Unless otherwise noted, all measurements performed as a downconverter, IF = 100 MHz



# CMD180C3

## 20-32 GHz Fundamental Mixer

### Specifications

#### Absolute Maximum Ratings

Parameter	Rating
RF / IF Input Power	+21 dBm
LO Drive	+21 dBm
Operating Temperature	-40 to 85 °C
Storage Temperature	-55 to 150 °C
Thermal Resistance, $\Theta_{JC}$	651.2 °C / W
Power Dissipation, P <sub>diss</sub>	99.8 mW

Exceeding any one or combination of the maximum ratings may cause permanent damage to the device.

#### Electrical Specifications - IF = 100 MHz, LO = +13 dBm, T<sub>A</sub> = 25 °C

Parameter	Min	Typ	Max	Min	Typ	Max	Units
Frequency Range, RF & LO	22 - 28			20 - 32			GHz
Frequency Range, IF	DC		10	DC		10	GHz
Conversion Loss		7	9		7	11	dB
Noise Figure (SSB)		7	9		7	11	dB
LO to RF Isolation	31	36		27	36		dB
LO to IF Isolation	30	38		27	38		dB
RF to IF Isolation	19	26		16	26		dB
Input P <sub>1dB</sub>		10			9		dBm
Input IP <sub>3</sub>		18			18		dBm

Unless otherwise noted, all measurements performed as a downconverter, IF = 100 MHz

ver 1.8 0419

### Typical Performance

**Conversion Gain vs. Temperature, LO = +13 dBm, IF = 100 MHz USB**

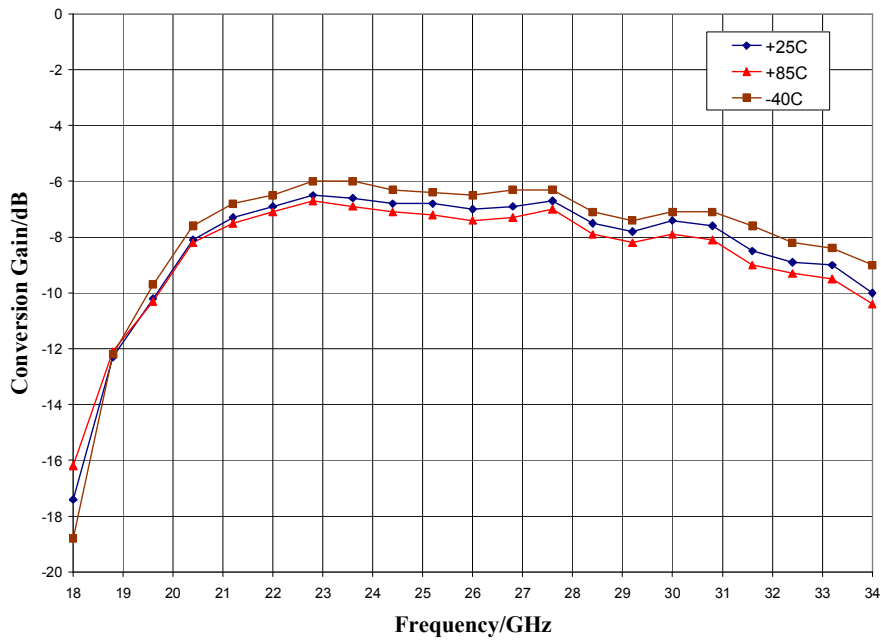

**Isolation, LO = +13 dBm**

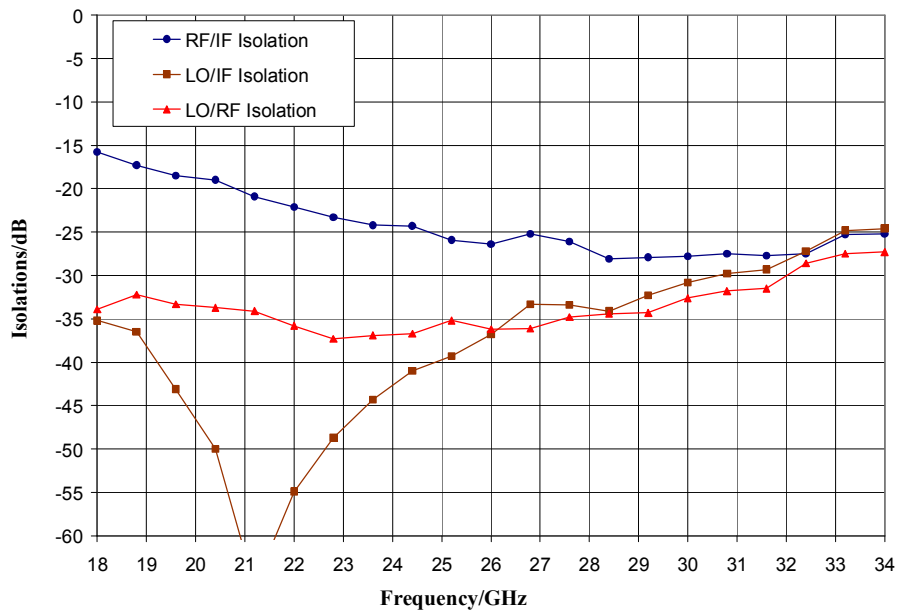

### Typical Performance

#### Conversion Gain vs. LO Drive, IF = 100 MHz USB

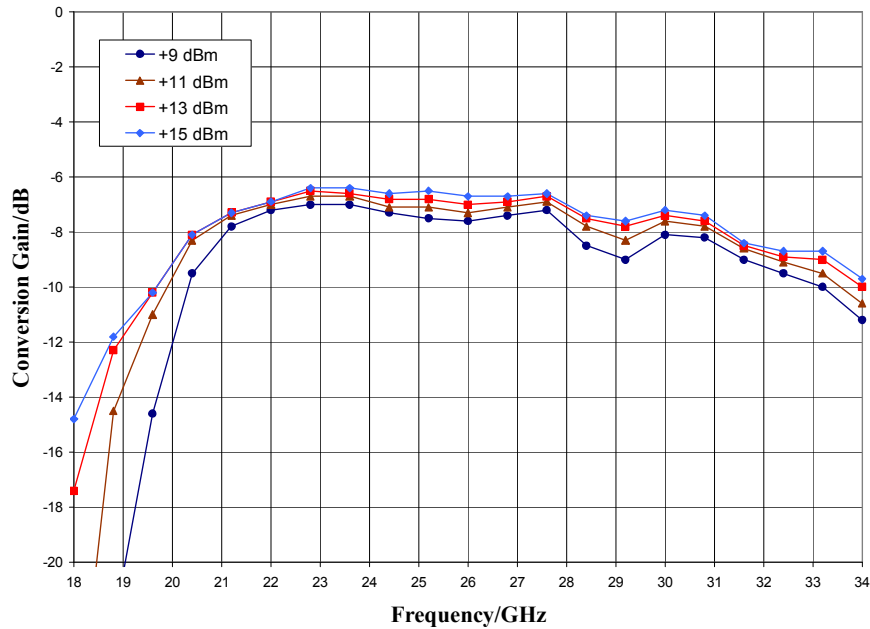

#### Return Loss, LO = + 13 dBm

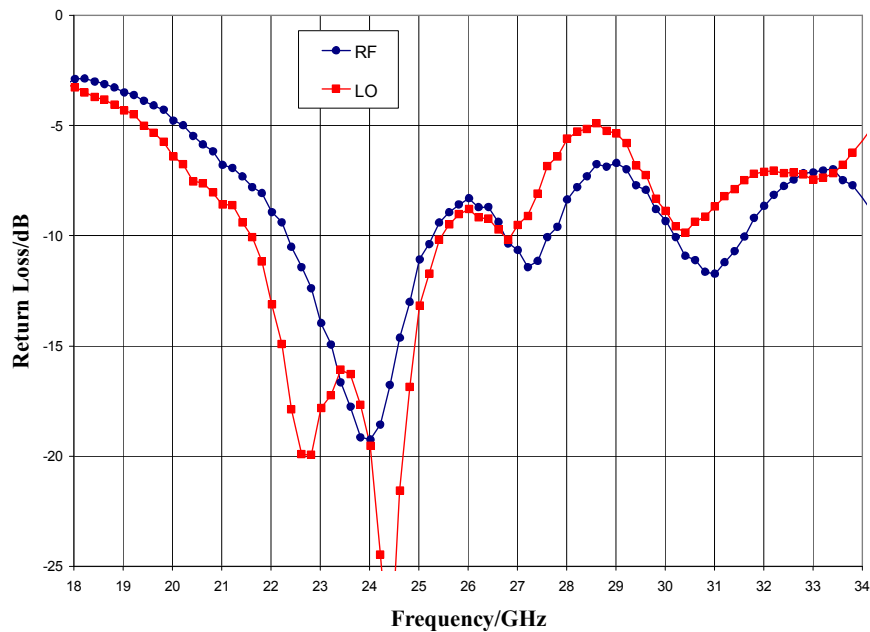

ver 1.8 0419

### Typical Performance

IF Bandwidth, LO = +13 dBm

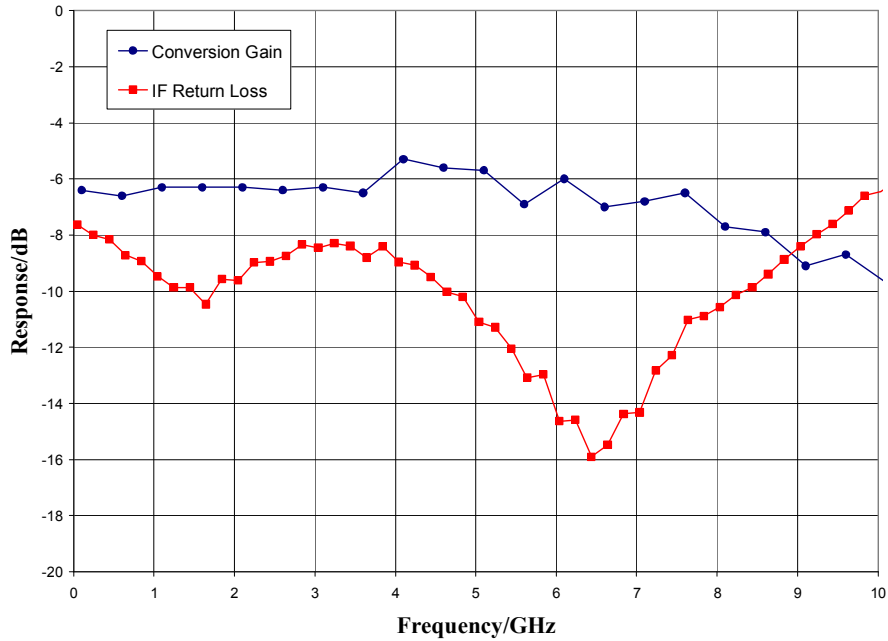

Upconverter Performance, Conversion Gain vs. LO Drive, IF input = 100 MHz

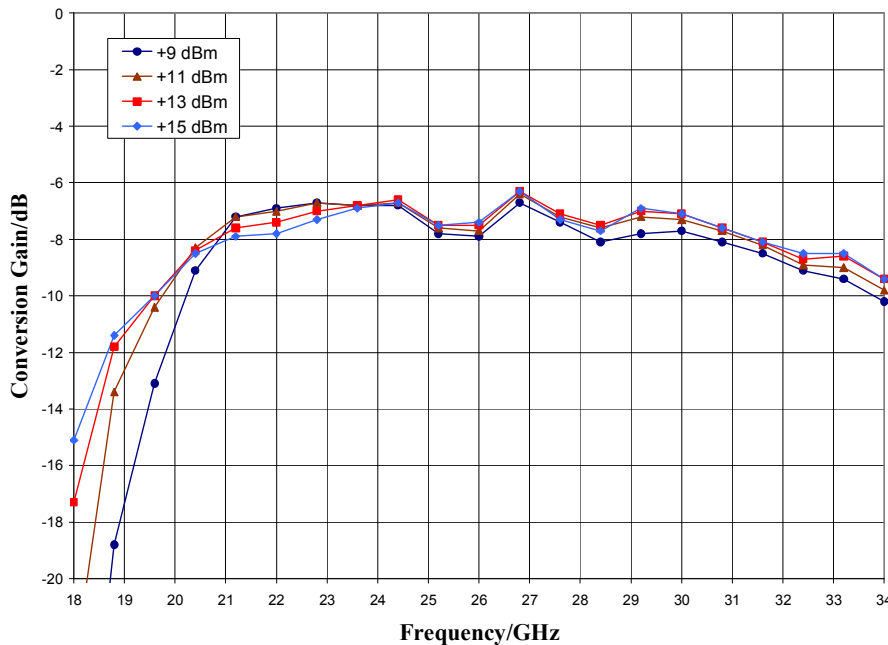

ver 1.8 0419

### Typical Performance

Input IP3 vs. Temperature, LO = +15 dBm, IF = 100 MHz

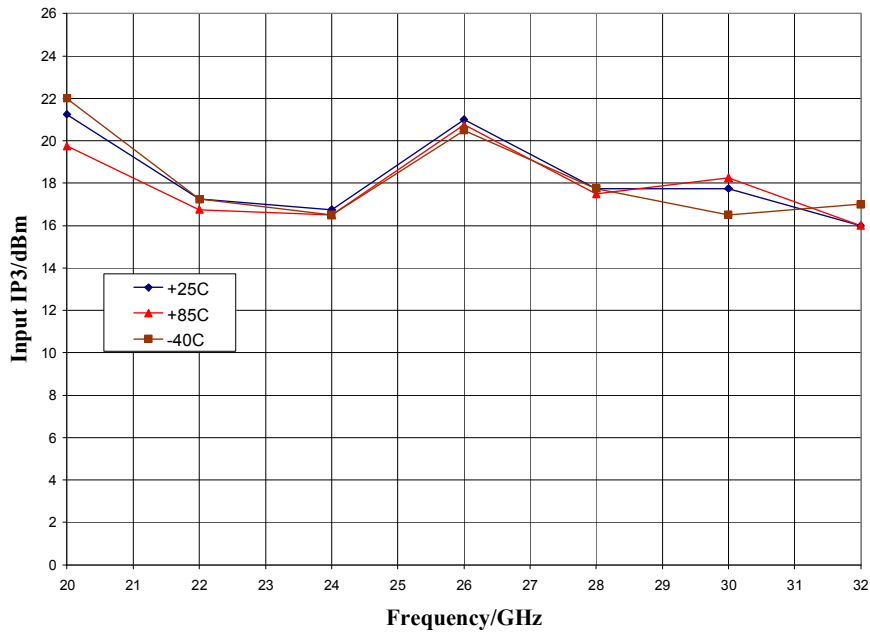

Input IP3 vs. LO Drive, IF = 100 MHz

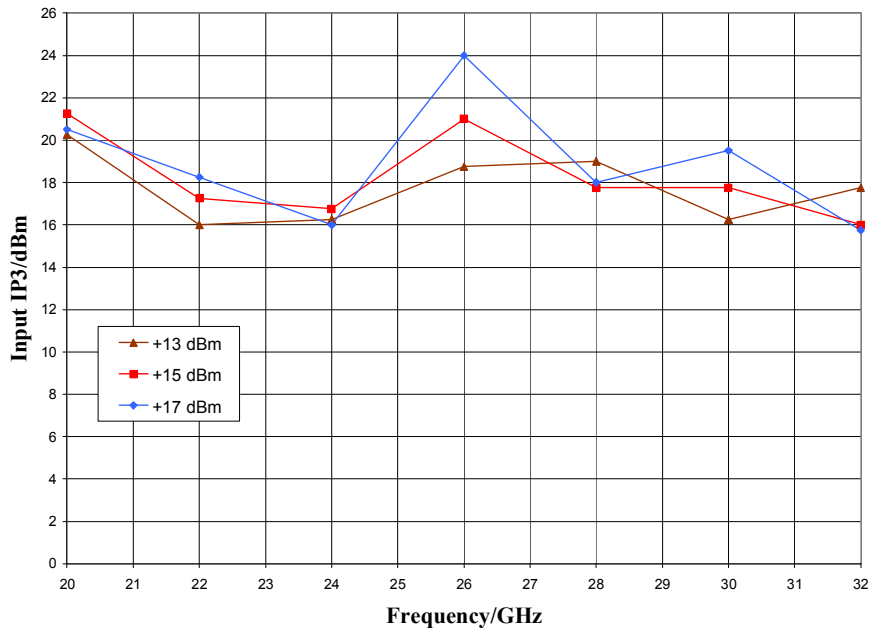

ver 1.8 0419

### Typical Performance

#### Upconverter Performance, Input IP3 vs. LO Drive, IF = 100 MHz

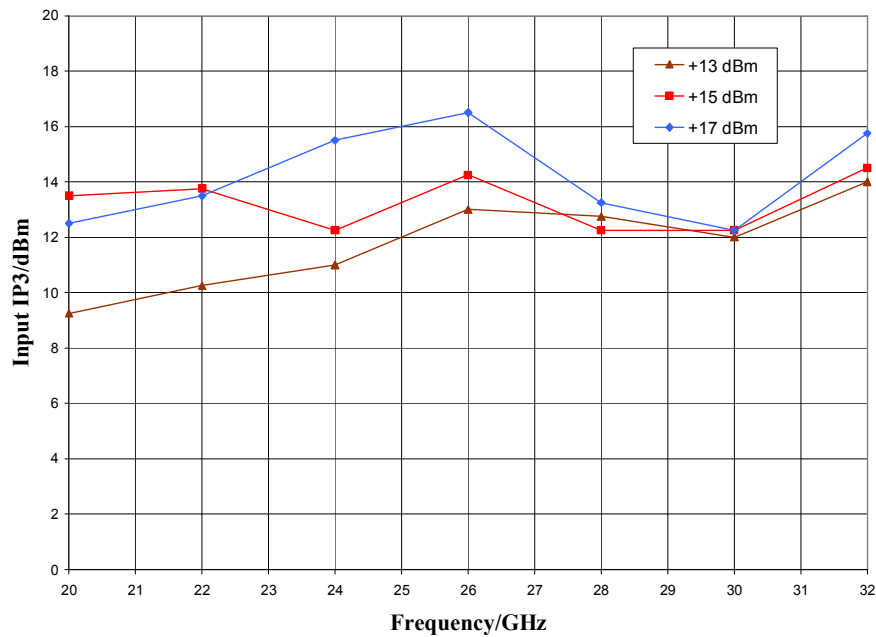

#### Input P1dB, LO = +13 dBm, IF = 100 MHz USB

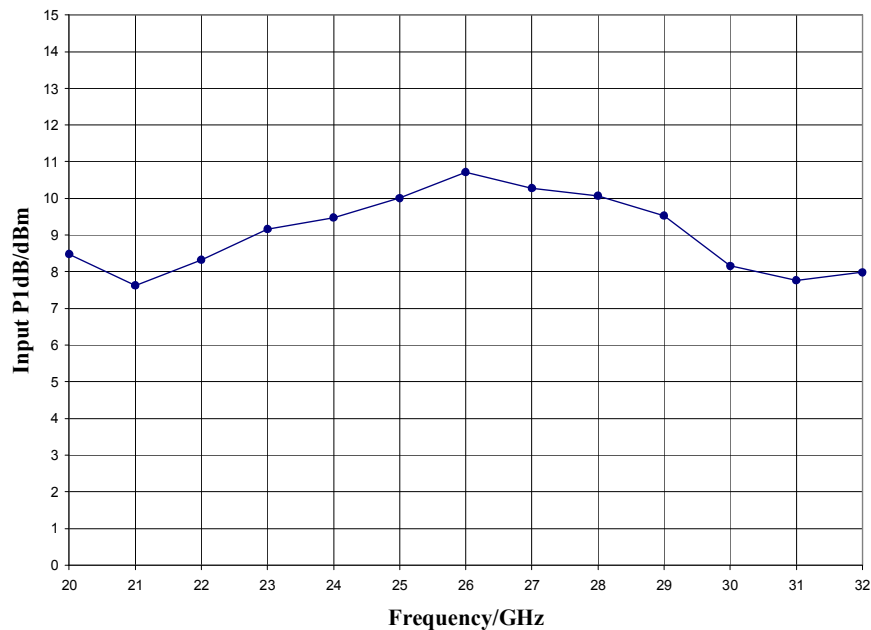

ver 1.8 0419

### Mechanical Information

#### Package Information and Dimensions

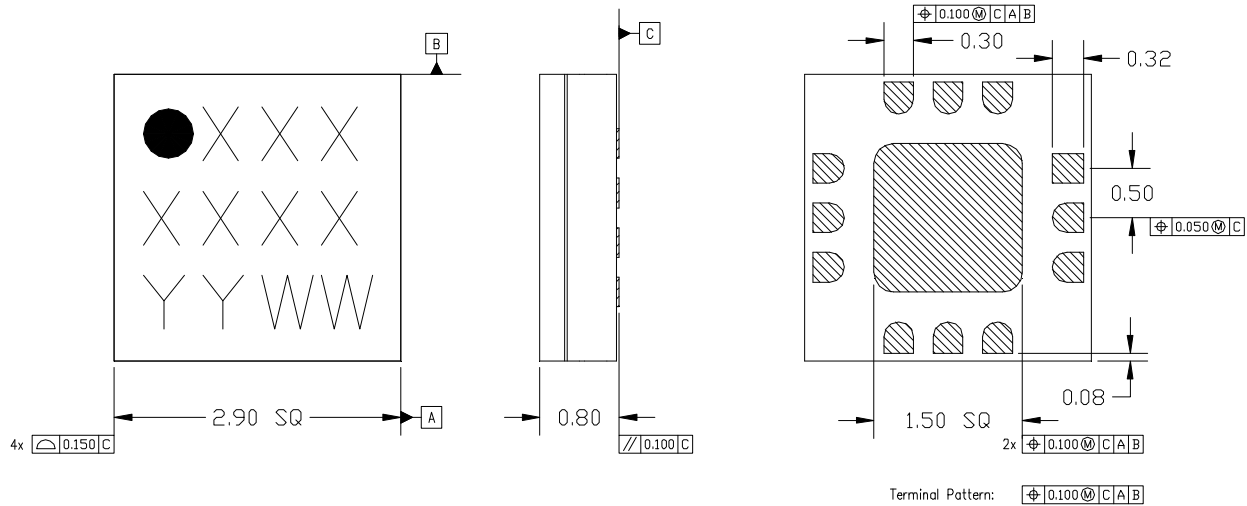

#### NOTES:

1. ALL DIMENSIONS SHOWN IN mm.
2. MATERIAL: BLACK ALUMINA
3. LEAD FINISH:
  - 3.1. Ni: 8.89um MAX, 1.27um MIN
  - 3.2. Pd: 0.17um MAX, 0.07um MIN
  - 3.3. Au: 0.254um MAX, 0.03um MIN
4. MARKING
  - 4.1. LINE 1: PART NUMBER
    - 4.1.1. EXAMPLE: CMD177C3 SHALL BE MARKED AS 177
  - 4.2. LINE 2: LDT NUMBER
  - 4.3. LINE 3: DATE CODE - LAST 2 DIGITS OF THE YEAR OF MANUFACTURE FOLLOWED BY A 2 DIGIT WEEK CODE
5. ALTERNATE PIN #1 IDENTIFIER IS A SINGLE SQUARE PAD
6. ALTERNATE DIE PADDLE MAY HAVE CHAMFERED CORNERS

#### Recommended PCB Land Pattern

Custom MMIC recommends that the user develop the land pattern that will provide the best design for proper solder reflow and device attach for their specific application. Please review Custom MMIC Application Note AN 105 for a recommended land pattern approach.

#### Recommended Solder Reflow Profile

Custom MMIC recommends screen printing with belt furnace reflow to ensure proper solder reflow and device attach. Please review Custom MMIC Application Note AN 102 for a recommended solder reflow profile.



### Pin Description

#### Pin Diagram

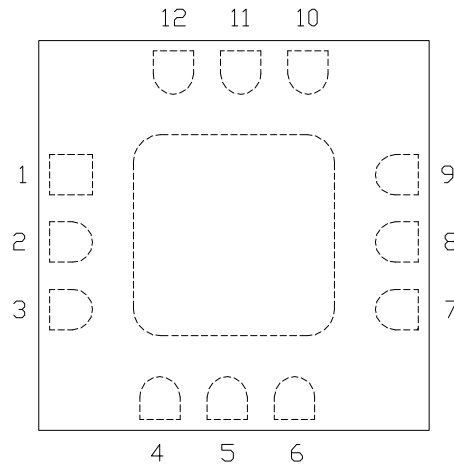

#### Functional Description

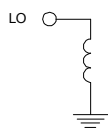
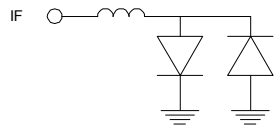
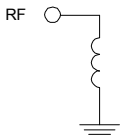
Pin	Function	Description	Schematic
1,3,4,6,7,9 and die paddle	Ground	Connect to RF / DC ground.	
2	LO	This pin is DC coupled and matched to 50 ohms.	
5	IF	This pin is DC coupled. For applications not requiring operation to DC, this port should be DC blocked externally using a series capacitor whose value has been chosen to pass the necessary IF frequency range. For operation to DC, this pin must not source or sink more than 16 mA of current or part non-function or part failure may result.	
8	RF	This pin is DC coupled and matched to 50 ohms.	
10-12	N/C	No connection required. These pins may be connected to RF/DC ground	

ver 1.8 0419