

Product Overview

Qorvo's CMD181K3 is a general purpose, double balanced mixer in a leadless 3 x 3 mm air cavity surface mount package. Operating over the RF bandwidth of 26 to 44 GHz, the mixer has very low conversion loss and high isolations to both the RF and IF ports due to the optimized balun structures. The mixer can also be configured as either an image reject mixer or a single sideband upconverter with external hybrids and power splitters. The CMD181K3 is a much smaller alternative to higher cost hybrid mixer assemblies.

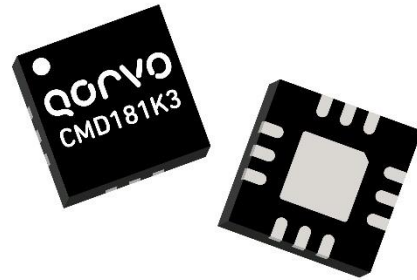

Functional Block Diagram

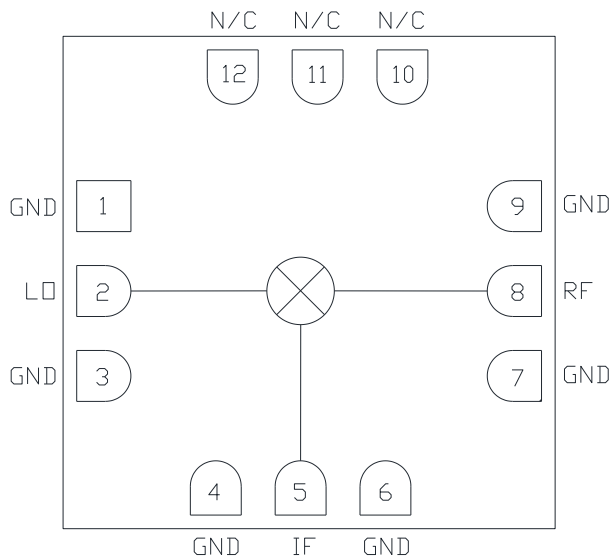

Key Features

- Single ended output
- RF, LO Frequency Range: 26 – 44 GHz
- IF Frequency Range: DC – 10 GHz
- Low conversion loss of 10 dB at 38 GHz
- High LO/RF isolation > 50 dB at 38 GHz
- Wide operating bandwidth
- Package dimensions: 3 x 3 x 1.2 mm

Performance is typical across frequency. Please reference electrical specification table and data plots for more details.

Applications

- Downconversion
- Upconversion
- Bi-phase modulation
- Low noise receiver systems
- Electronic Warfare (EW)

Ordering Information

Part No.	Description
CMD181K3	100 pcs tape & reel
CMD181K3EVB	Evaluation Board

Absolute Maximum Ratings

Parameter	Rating
LO, RF, or IF power, CW, 25 °C	+25 dBm
Channel Temperature, T _{ch}	150 °C
Operating Temperature	-40 to 85 °C
Storage Temperature	-55 to 150 °C
Mounting Temperature (30 sec)	260 °C

Exceeding any one or a combination of the Absolute Maximum Rating conditions may cause permanent damage to the device. Extended application of Absolute Maximum Rating conditions to the device may reduce device reliability.

Recommended Operating Conditions

Parameter	Min	Typ.	Max	Units
LO Drive Power	+13	+17	+23	dBm
RF input Power (downconversion)			+19	dBm
IF Input Power (upconversion)			+19	dBm
Temperature Range	-40	+25	+85	°C

Electrical specifications are measured at specified test conditions. Specifications are not guaranteed over all recommended operating conditions.

Electrical Specifications

Test conditions unless otherwise noted: 25 °C, IF = 5 GHz USB, LO = +17 dBm

Parameter	Min	Typ.	Max	Units
RF, LO Operational Frequency Range	26	–	44	GHz
IF Frequency Range	DC	–	10	GHz
Conversion Gain	-13.5	-10	–	dB
LO to RF Isolation	–	40	–	dB
LO to IF Isolation	–	32	–	dB
Input Power (P _{1dB})	–	+14	–	dBm
Input IP3	–	+27	–	dBm

Typical Performance – Data Taken as Downconverter, IF=5 GHz USB

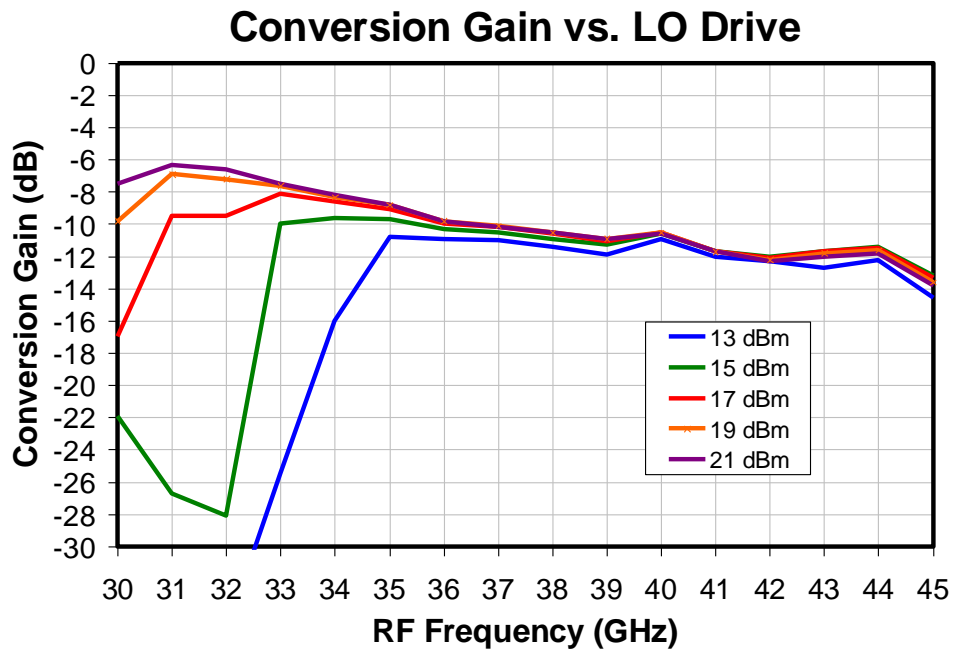
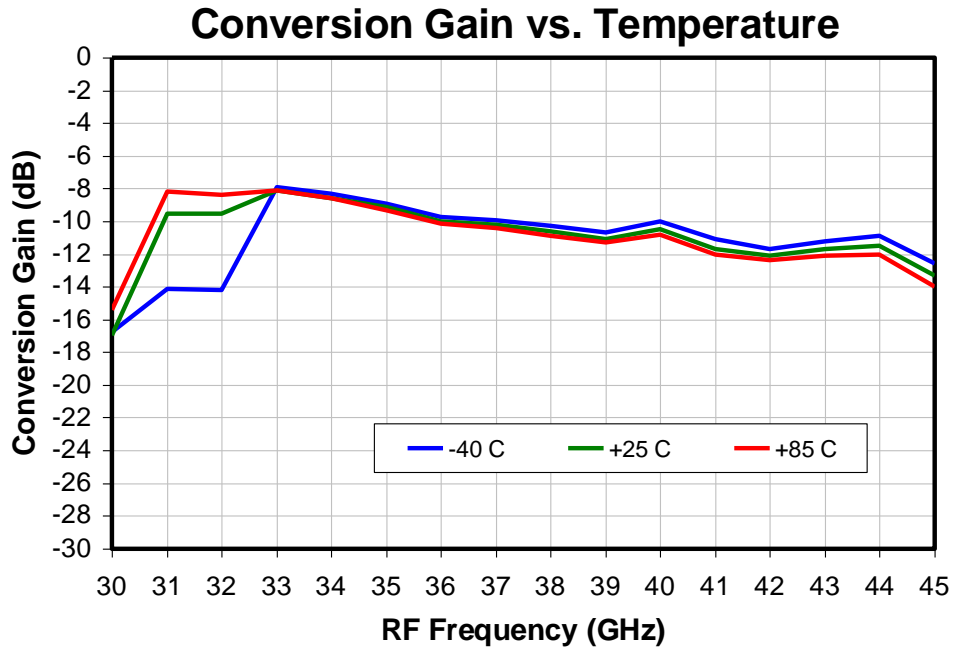

Typical Performance – Data Taken as Downconverter, IF=5 GHz USB

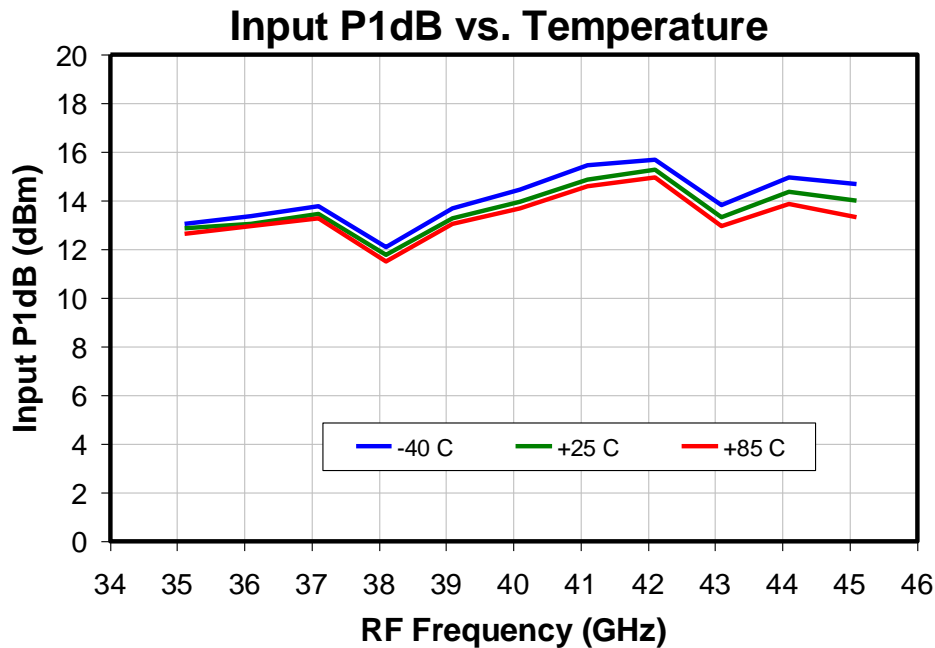
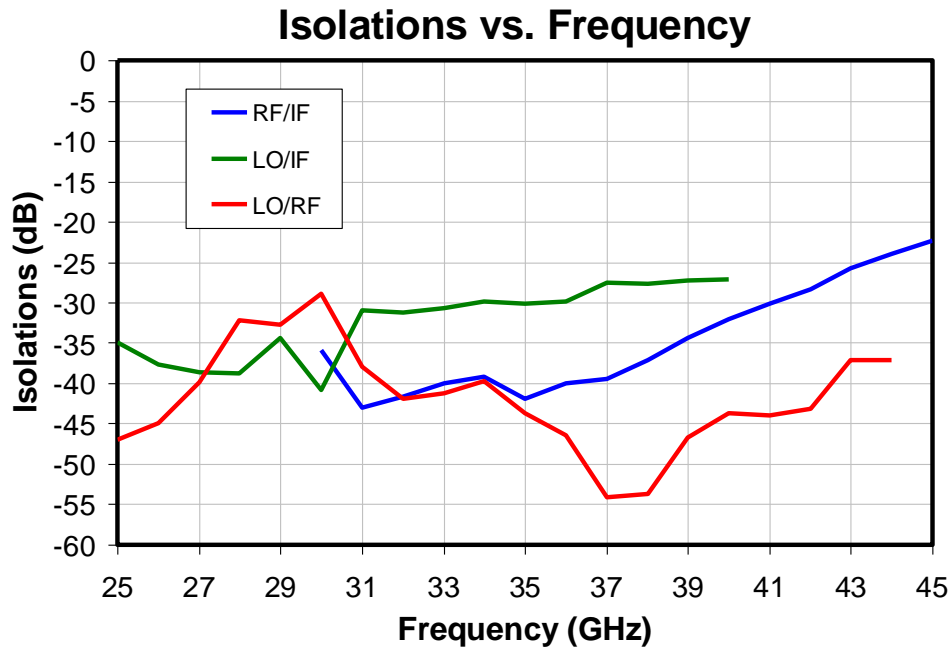

Typical Performance – Data Taken as Downconverter, IF=5 MHz USB

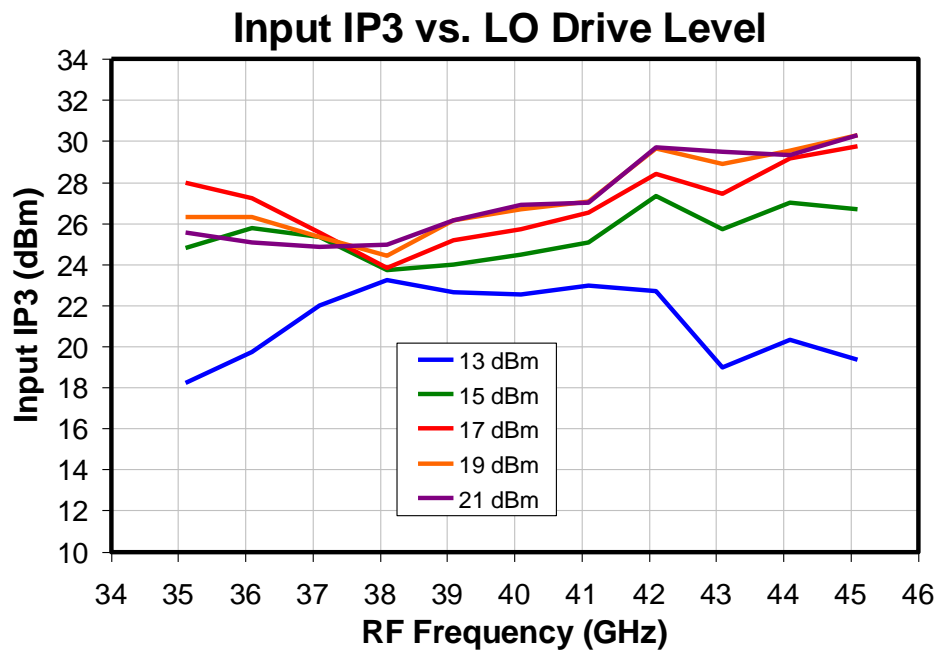
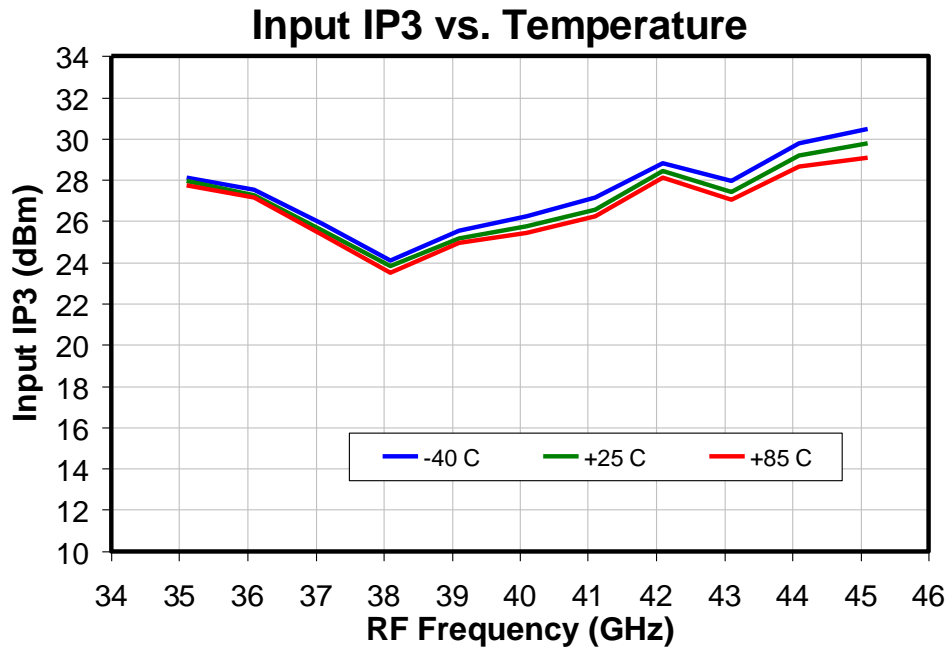

Typical Performance – Data Taken as Upconverter, IF=600 MHz USB

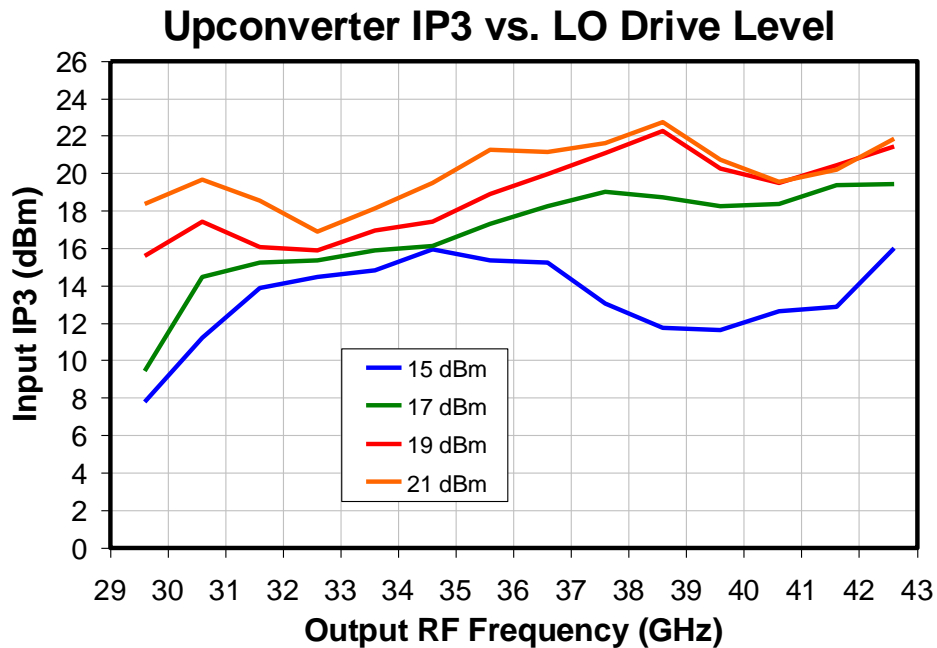
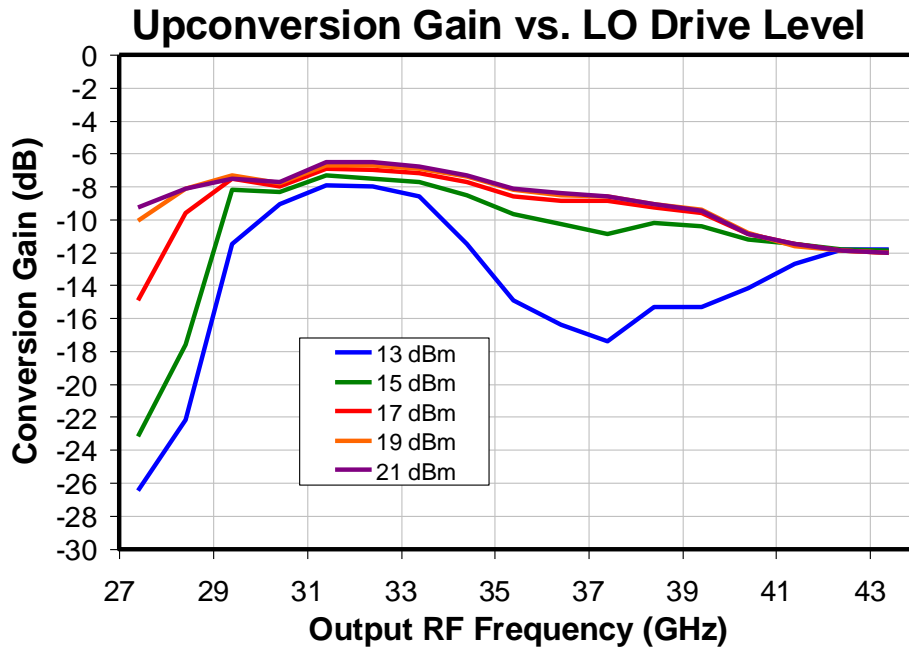

Typical Performance

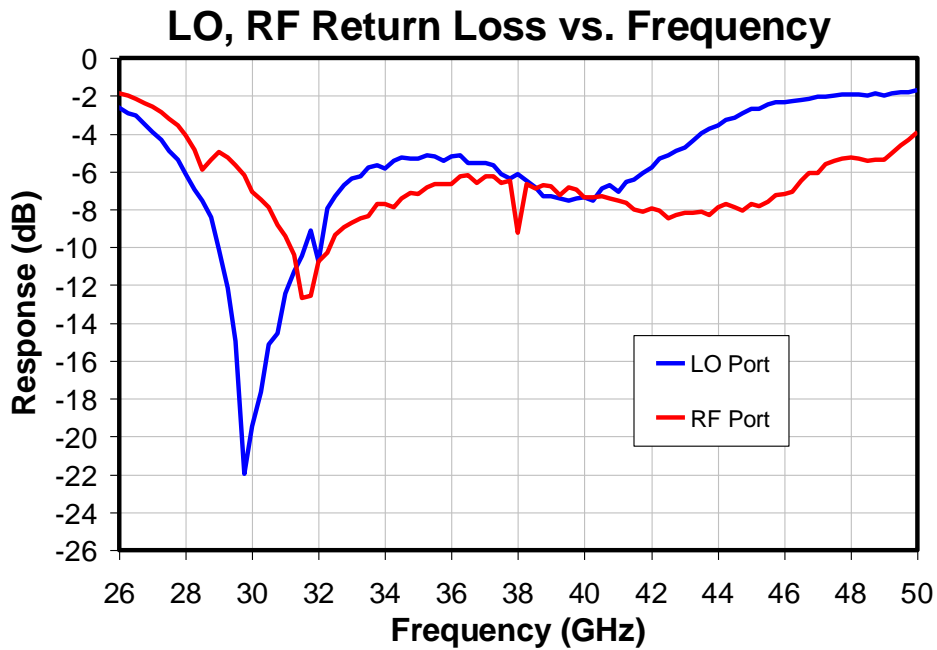
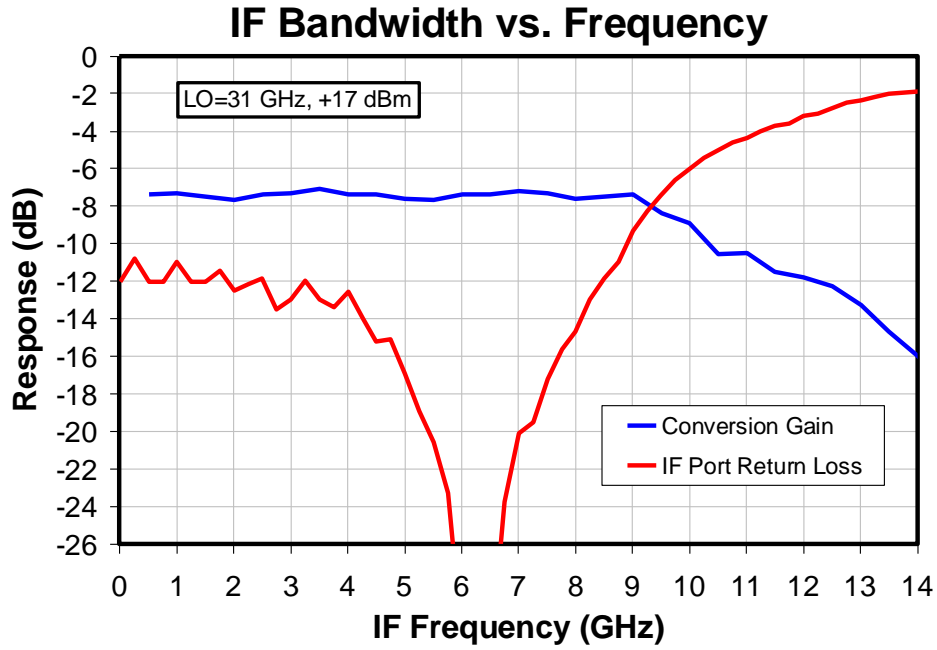

Thermal and Reliability Information

Parameter	Test Conditions	Value	Units
Thermal Resistance (θ_{JC}) ⁽¹⁾	$T_{BASE} = 85\text{ }^{\circ}\text{C}$, CW, LO $P_{IN} = 17\text{ dBm}$ (0.05 W), $P_{DISS} = 0.05\text{ W}$	302.8	$^{\circ}\text{C/W}$
Channel Temperature (T_{CH}) ⁽¹⁾		100.14	$^{\circ}\text{C}$
Median Lifetime (T_M)		6.0E6	Hrs

Notes:

1. Measured to the back of the package.

Spur Performance

mRF	nLO				
	0	1	2	3	4
0	x	-3			
1	28	0	52		
2		61	58	65	
3				68	
4					

RF = 39.1 GHz, -10 dBm

LO = 34 GHz, +17 dBm

All values in dBc below IF output power level (1RF – 1LO)

Data taken as downconverter

Evaluation Board (EVB) Assembly Layout

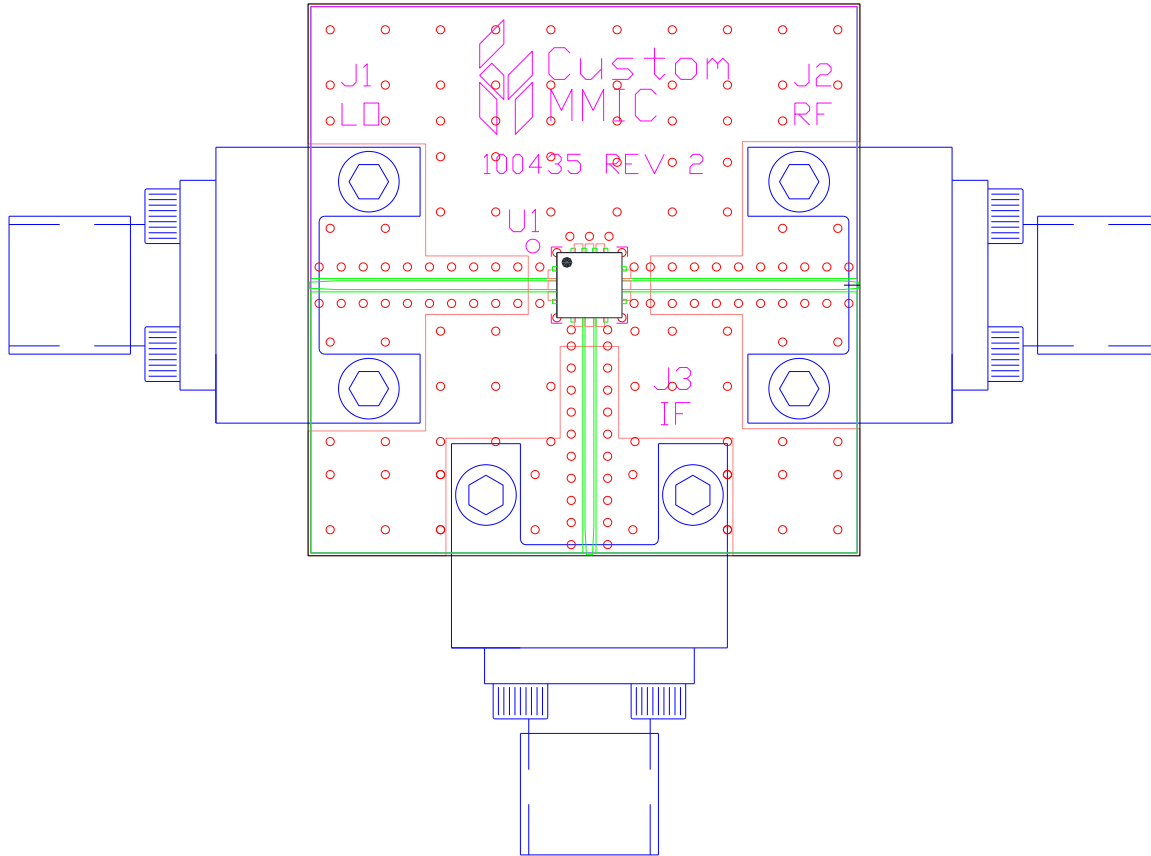

Bill of Materials for CMD181K3-EVB

Reference Des.	Value	Description	Manuf.	Part Number
J1, J2, J3		2.4 mm End Launch "V" Connector		
U1		CMD181K3 I/Q Mixer	Qorvo	
PCB		100435 Evaluation PCB		

Mechanical Information

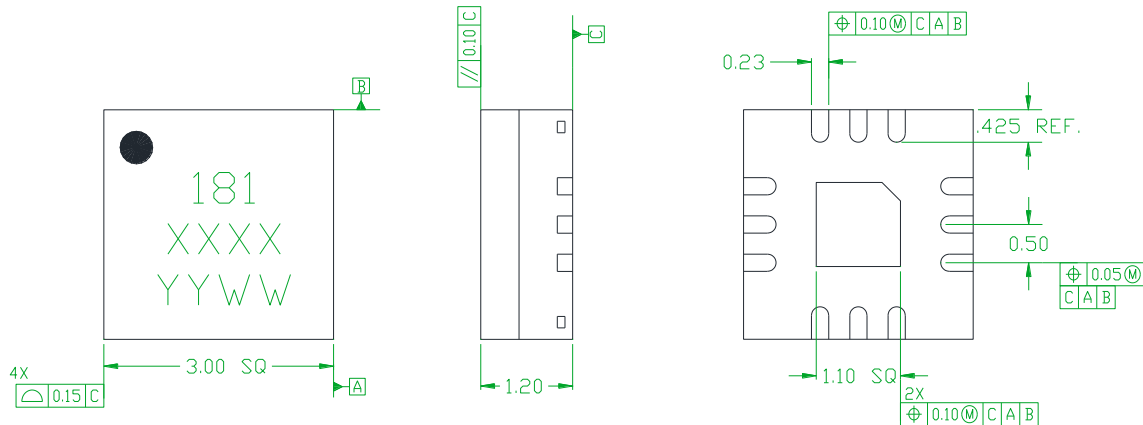

NOTES:

1. ALL DIMENSIONS AND TOLERANCES ARE WITHIN THOSE INDICATED IN JEDEC MO-220 WITH EXCEPTION OF TOTAL THICKNESS. ALL DIMENSION SHOWN AS mm. CONTROLLING DIMENSION ARE IN mm.
2. LEAD FINISH: ELECTROLESS NICKEL ELECTROLESS PALLADIUM IMMERSION GOLD (ENEPIG) PLATING IN ACCORDANCE WITH IPC-4556
3. MARKING: ALL MARKING SHALL BE PERMANENT AND LEGIBLE
LINE 1: PART NUMBER AS INDICATED
LINE 2: LOT NUMBER SHALL CONSIST OF THE LAST 4 DIGITS OF THE PD NUMBER
LINE 3: DATE CODE SHALL CONSIST OF THE LAST 2 DIGITS OF THE YEAR OF MANUFACTURE FOLLOWED BY A 2-DIGIT WEEK CODE.
4. INDICATED DIMENSION/TOLERANCE APPLIES TO LEADS AND EXPOSED PAD.
5. REFERENCE ASSEMBLY DRAWING 102712 FOR ASSEMBLY INFORMATION.
6. ALTERNATE PIN #1 IDENTIFIER WITH CORNER CHAMFER ON GROUND PADDLE IS ACCEPTABLE.

Recommended PCB Land Pattern

Qorvo recommends that the user develop the land pattern that will provide the best design for proper solder reflow and device attach for their specific application. Please review Qorvo Application Note AN 105 for a recommended land pattern approach.

Recommended Solder Reflow Profile

Qorvo recommends screen printing with belt furnace reflow to ensure proper solder reflow and device attach. Please review Qorvo Application Note AN 102 for a recommended solder reflow profile.

Pin Diagram

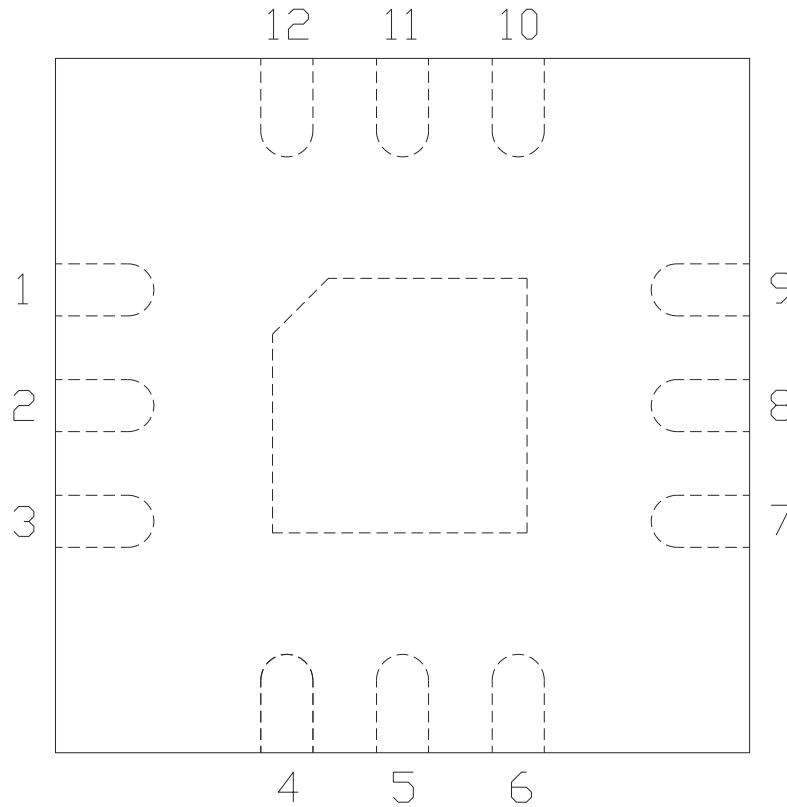

Pin Description

Pad No.	Symbol	Description
1, 3, 4, 6, 7, 9, and die paddle	Ground	Connect to RF / DC ground.
2	LO	This pin is DC coupled and matched to 50 Ohms.
5	IF	This pin is DC coupled. For applications not requiring operation to DC, this port should be DC blocked externally using a series capacitor whose value has been chosen to pass the necessary IF frequency range. For operation to DC, this pin must not source or sink more than 16 mA of current or part non-function or part failure may result.
8	RF	This pin is DC coupled and matched to 50 Ohms.
10-12	N/C	No connection required. These pins may be connected to RF/DC ground.

Assembly Notes

1. Compatible with lead-free soldering processes with 260°C peak reflow temperature.
2. Contact plating: ENEPIG
3. Solder rework not recommended.
4. See Application Note AN102 for further information regarding soldering.

Recommended Soldering Temperature Profile

