

Product Overview

The CMD231C3 is a wideband GaAs MMIC driver amplifier housed in a leadless 3x3 mm surface mount package. The CMD231C3 is ideally suited for military, space and communications systems where small size and high linearity are needed. At 4 GHz the device delivers greater than 14.5 dB of gain with a corresponding output 1 dB compression point of +13.5 dBm and an output IP3 of 23.5 dBm. The CMD231C3 is a 50 ohm matched design which eliminates the need for external DC blocks and RF port matching.

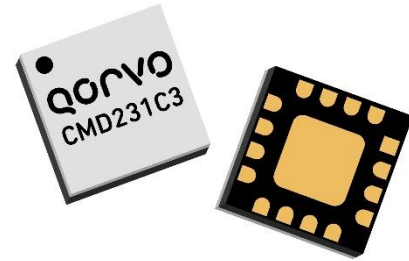

Functional Block Diagram

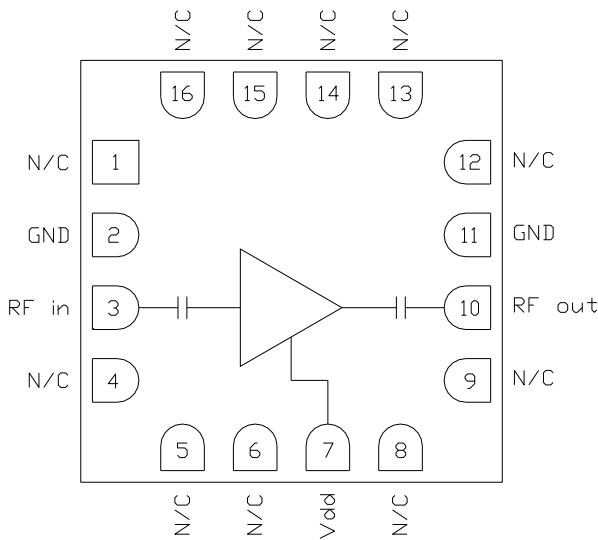

Key Features

- High Gain
- Single Positive Supply Voltage
- Low Current Consumption
- Pb-Free RoHS Compliant 3x3 QFN Package

Ordering Information

Part No.	Description
CMD231C3	2-6 GHz Driver Amplifier, 100 Piece 7" Reel
CMD231C3-EVB	Evaluation Board

Electrical Performance ($V_{dd} = 8.0 \text{ V}$, $T_A = 25 \text{ }^\circ\text{C}$, $F = 4 \text{ GHz}$)

Parameter	Min	Typ	Max	Units
Frequency Range		2 - 6		GHz
Gain		14.5		dB
Input Return Loss		15		dB
Output Return Loss		10		dB
Output P1dB		13.5		dBm
Output IP3		23.5		dBm
Supply Current		45		mA

Absolute Maximum Ratings

Parameter	Rating
Drain Voltage, V_{dd}	9 V
RF Input Power	+20 dBm
Channel Temperature, T_{ch}	150 °C
Power Dissipation, P_{diss}	919 mW
Thermal Resistance, θ_{JC}	70.7 °C/W
Operating Temperature	-55 to 85 °C
Storage Temperature	-55 to 150 °C

Exceeding any one or combination of the maximum ratings may cause permanent damage to the device.

Recommended Operating Conditions

Parameter	Min	Typ	Max	Units
V_{dd}	3.0	8.0	8.25	V
I_{dd}		45		mA

Electrical performance is measured at specific test conditions. Electrical specifications are not guaranteed over all recommended operating conditions.

Electrical Specifications ($V_{dd} = 8.0$ V, $T_A = 25$ °C)

Parameter	Min	Typ	Max	Units
Frequency Range		2 - 6		GHz
Gain	11.5	14.5	18	dB
Noise Figure		4.5		dB
Input Return Loss		15		dB
Output Return Loss		10		dB
Output P1dB	11	13.5		dBm
Output IP3		23.5		dBm
Supply Current	30	45	60	mA
Gain Temperature Coefficient		0.015		dB/°C
Noise Figure Temperature Coefficient		0.01		dB/°C

Typical Performance

Broadband Performance, $V_{dd} = 8.0\text{ V}$, $I_{dd} = 45\text{ mA}$, $T_A = 25\text{ °C}$

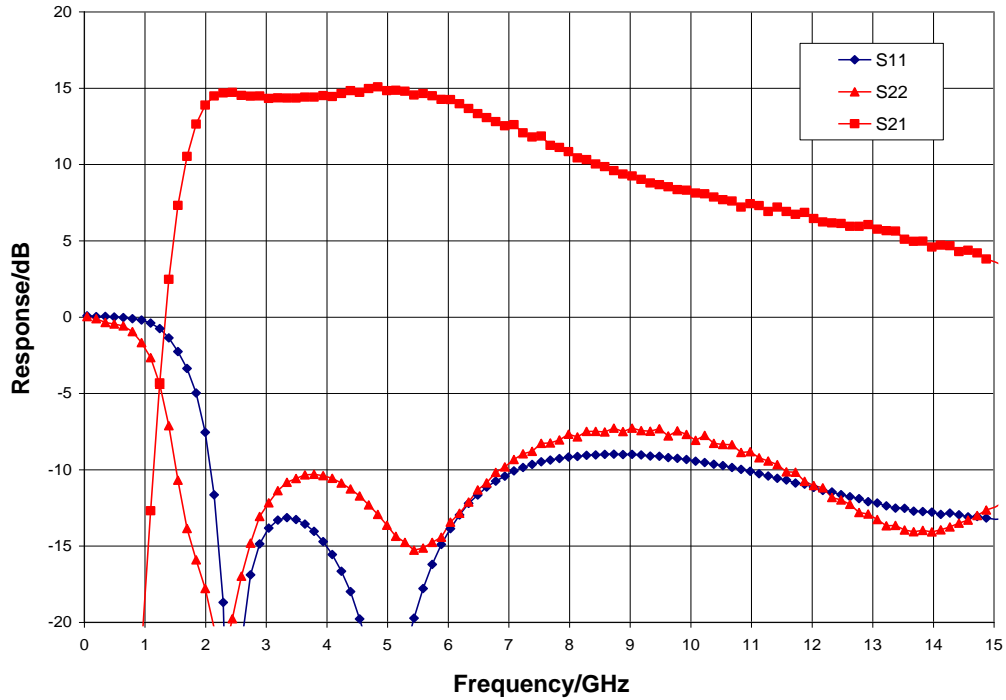

Narrow-band Performance, $V_{dd} = 8.0\text{ V}$, $I_{dd} = 45\text{ mA}$, $T_A = 25\text{ °C}$

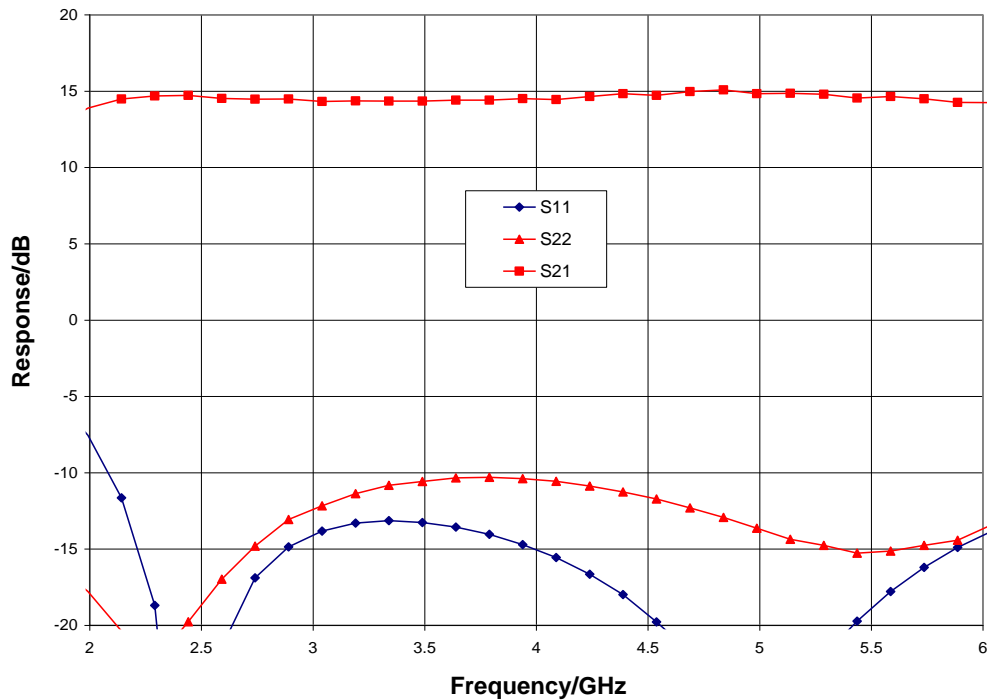

Typical Performance

Gain vs. Temperature, $V_{dd} = 8.0\text{ V}$

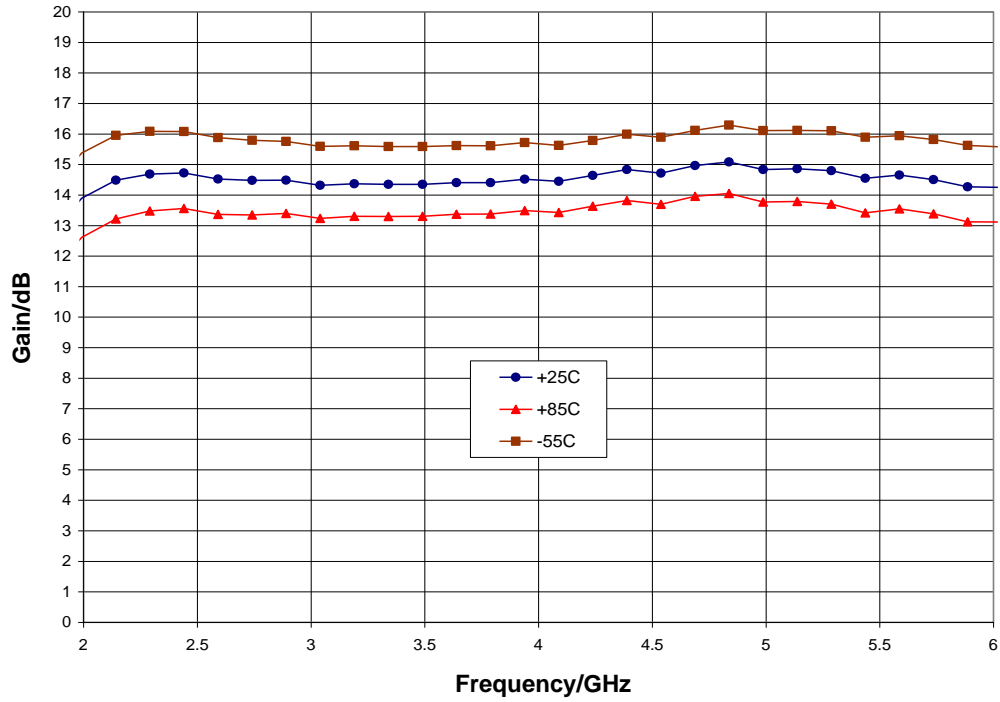

Gain vs. Supply Voltage, $T_A = 25\text{ }^\circ\text{C}$

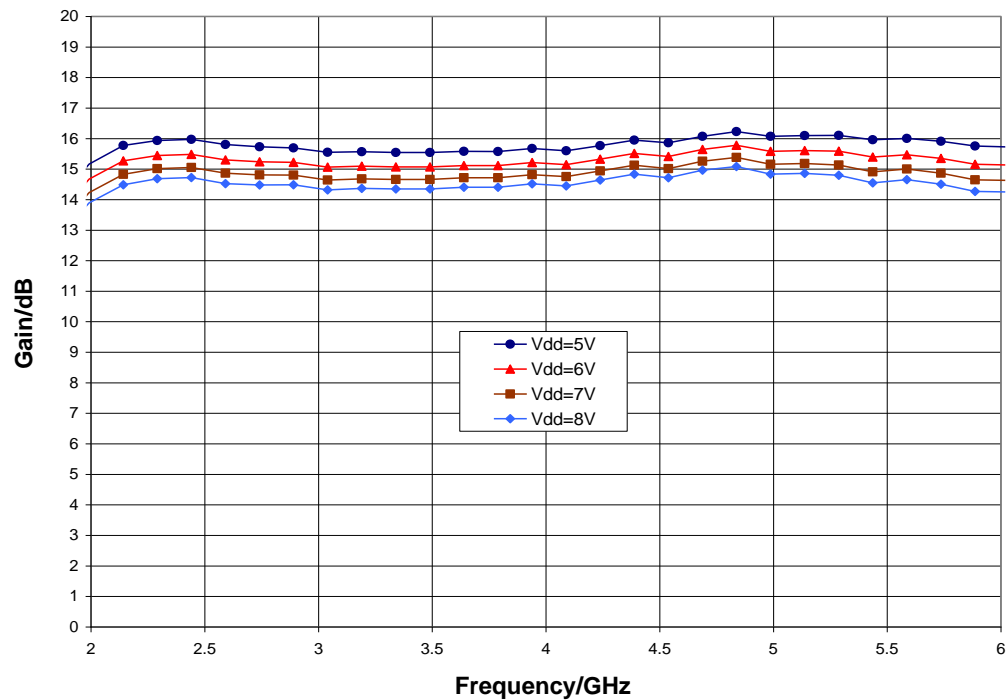

Typical Performance

Noise Figure vs. Temperature, $V_{dd} = 8.0\text{ V}$

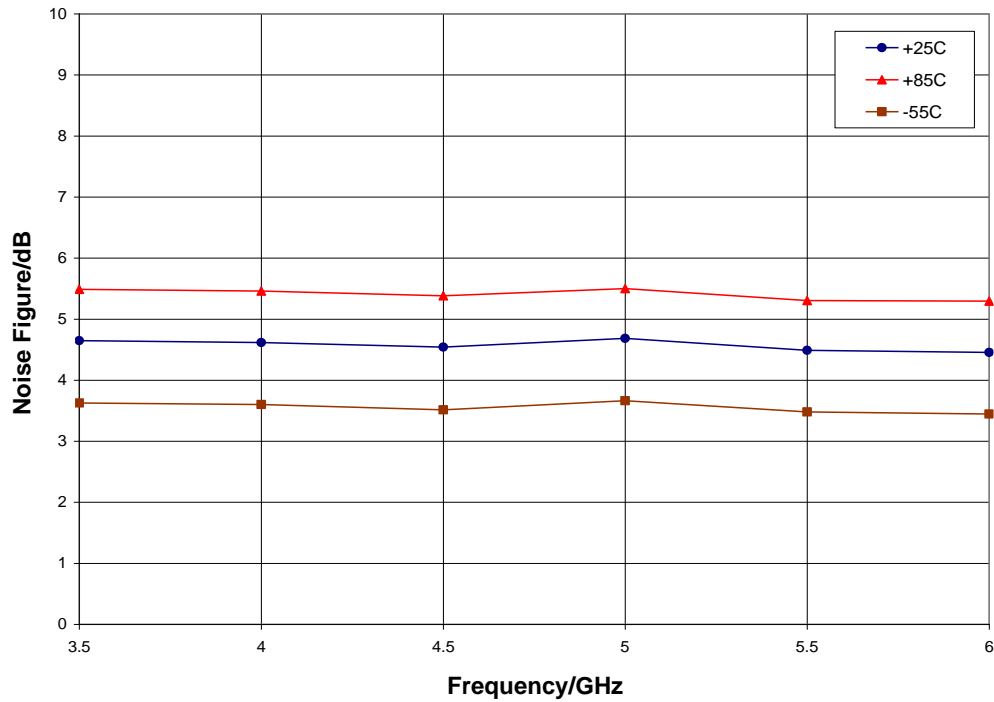

Noise Figure vs. Supply Voltage, $T_A = 25\text{ }^\circ\text{C}$

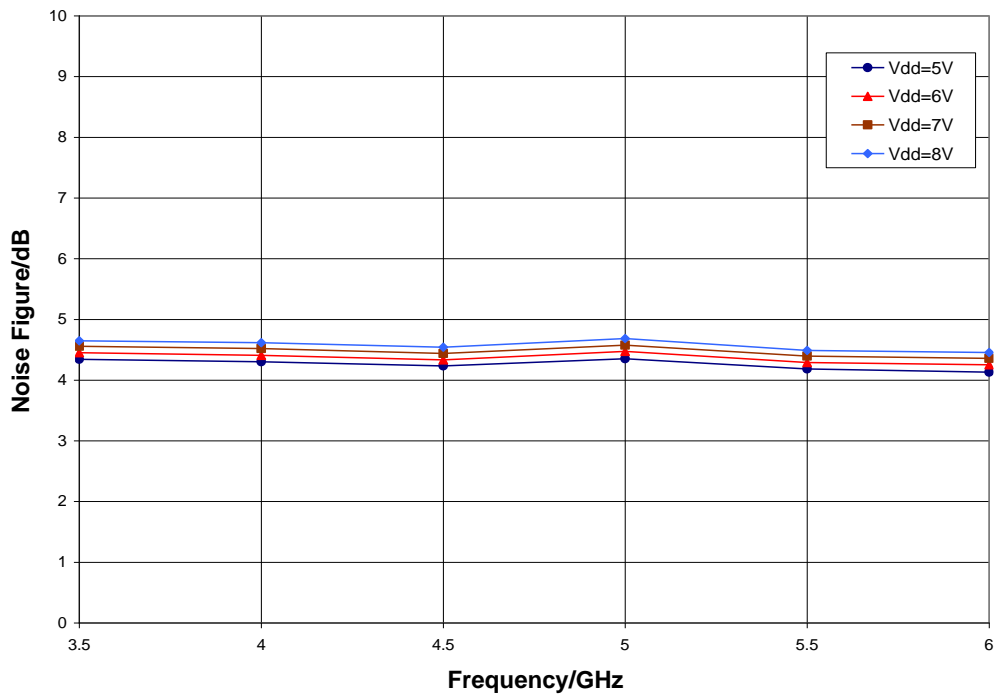

Typical Performance

P1dB vs. Temperature, $V_{dd} = 8.0\text{ V}$

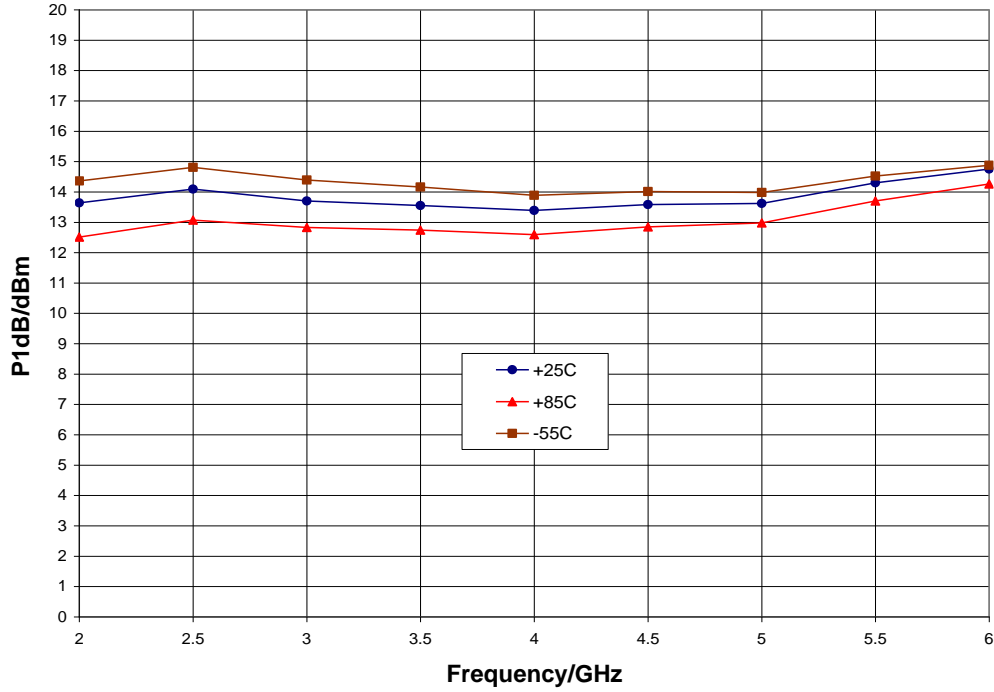

P1dB vs. Supply Voltage, $T_A = 25\text{ }^\circ\text{C}$

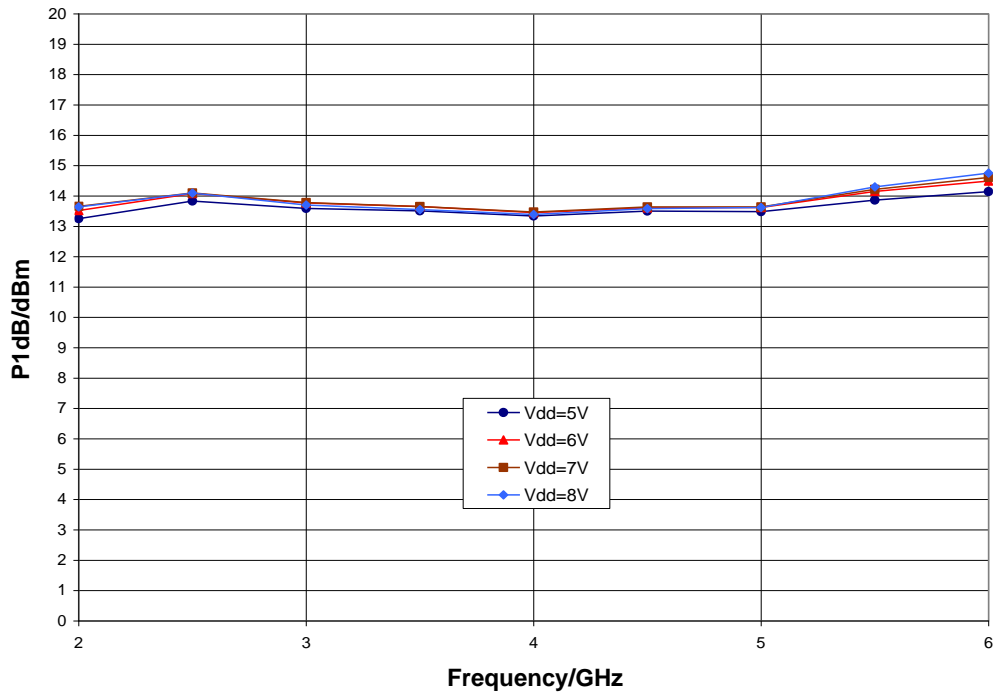

Typical Performance

Output IP3 vs. Temperature, $V_{dd} = 8.0 \text{ V}$

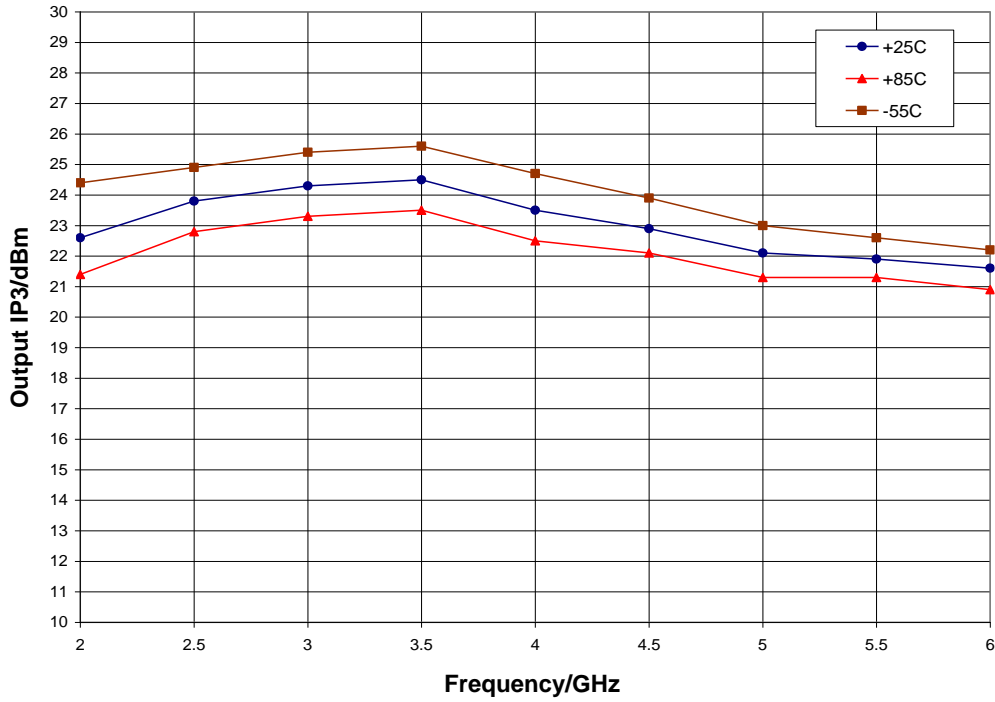

Output IP3 vs. Supply Voltage, $T_A = 25 \text{ }^\circ\text{C}$

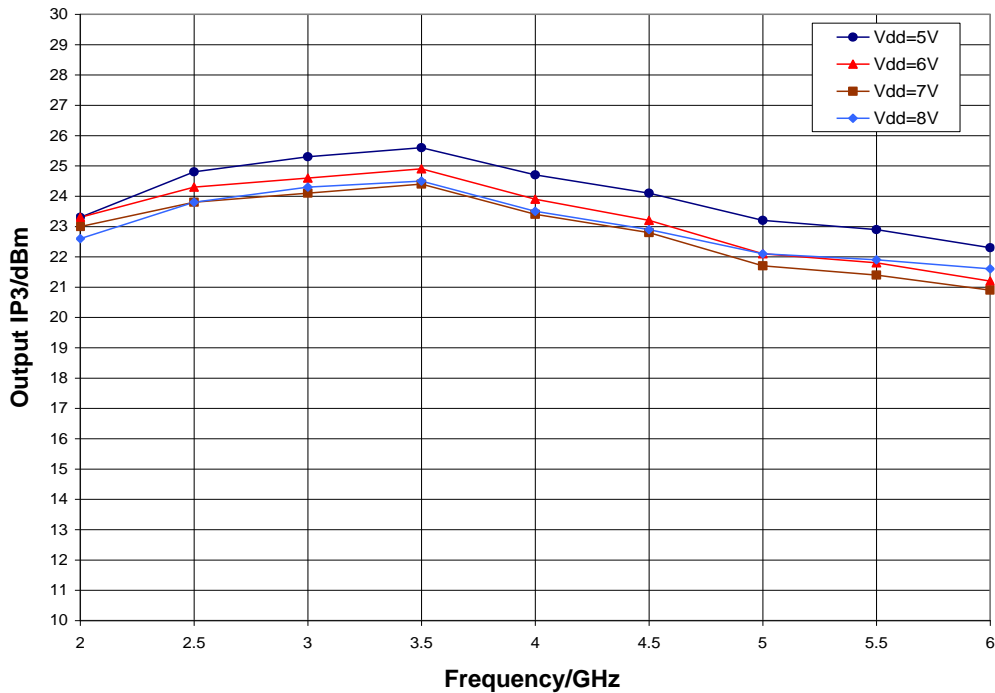

Typical Performance

Output Power, $V_{dd} = 8.0\text{ V}$, $T_A = 25\text{ °C}$

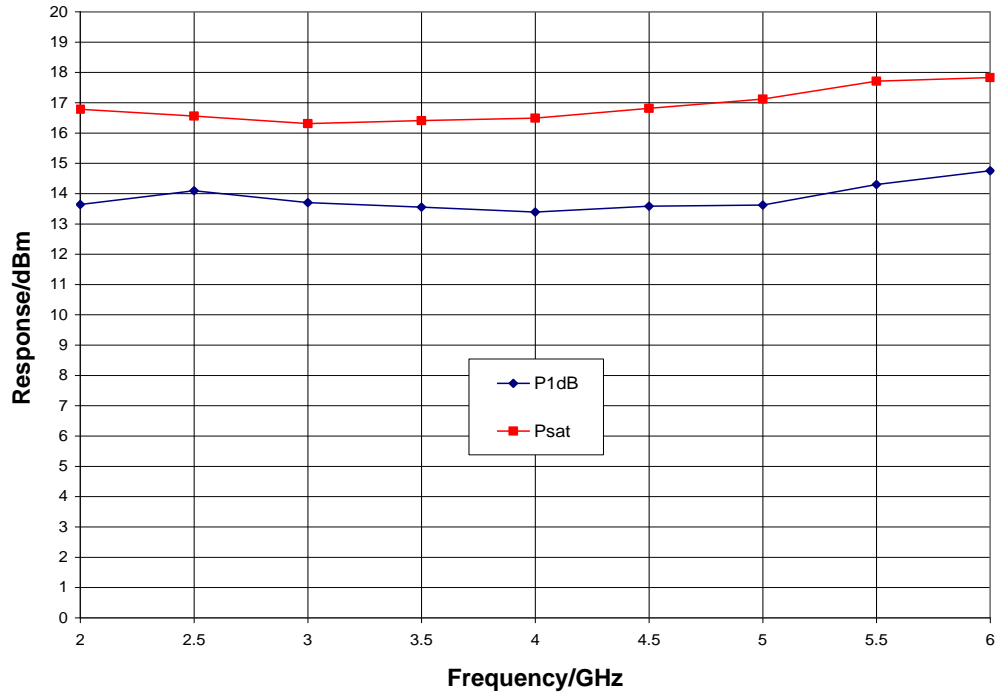

Mechanical Information

Package Information and Dimensions

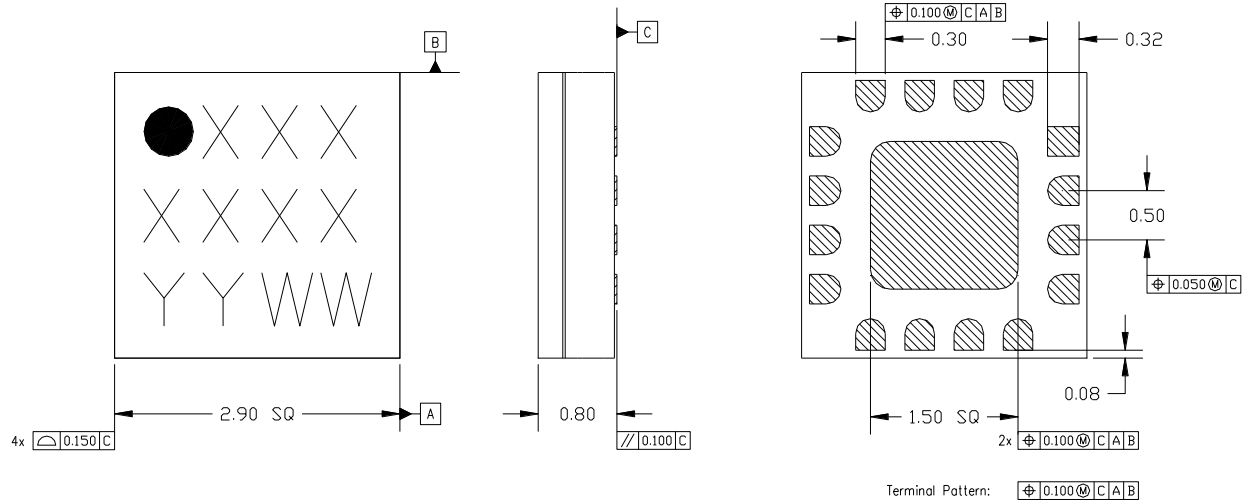

Notes:

1. All dimensions shown in mm.
2. Material: Black alumina
3. Lead finish
 - 3.1. Ni: 8.89um max, 1.27um min
 - 3.2. Pd: 0.17um max, 0.07um min
 - 3.3. Au: 0.254um max, 0.03um min
4. Marking
 - 4.1. Line 1: Part number
 - 4.1.1. Example: CMD231C3 shall be marked as 231
 - 4.2. Line 2: Lot number
 - 4.3. Line 3: Date code - Last 2 digits of the year of manufacture followed by a 2 digit week code
5. Alternate pin #1 identifier is a single square pad
6. Alternate die paddle may have chamfered corners

Recommended PCB Land Pattern

Qorvo recommends that the user develop the land pattern that will provide the best design for proper solder reflow and device attach for their specific application. Please review Qorvo Application Note AN 105 for a recommended land pattern approach.

Recommended Solder Reflow Profile

Qorvo recommends screen printing with belt furnace reflow to ensure proper solder reflow and device attach. Please review Qorvo Application Note AN 102 for a recommended solder reflow profile.

Pin Description

Pin Diagram

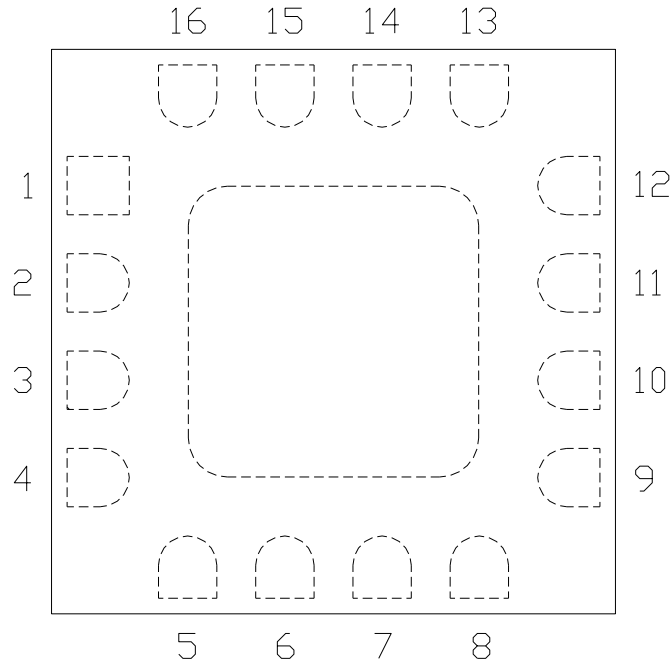

Functional Description

Pin	Function	Description	Schematic
1, 4 - 6, 8, 9, 12 - 16	N/C	No connection required These pins may be connected to RF / DC ground	
3	RF in	DC blocked and 50 ohm matched	
7	V _{dd}	Power supply voltage Decoupling and bypass caps required	
10	RF out	DC blocked and 50 ohm matched	
2, 11 and die paddle	Ground	Connect to RF / DC ground	

Applications Information

Application Circuit

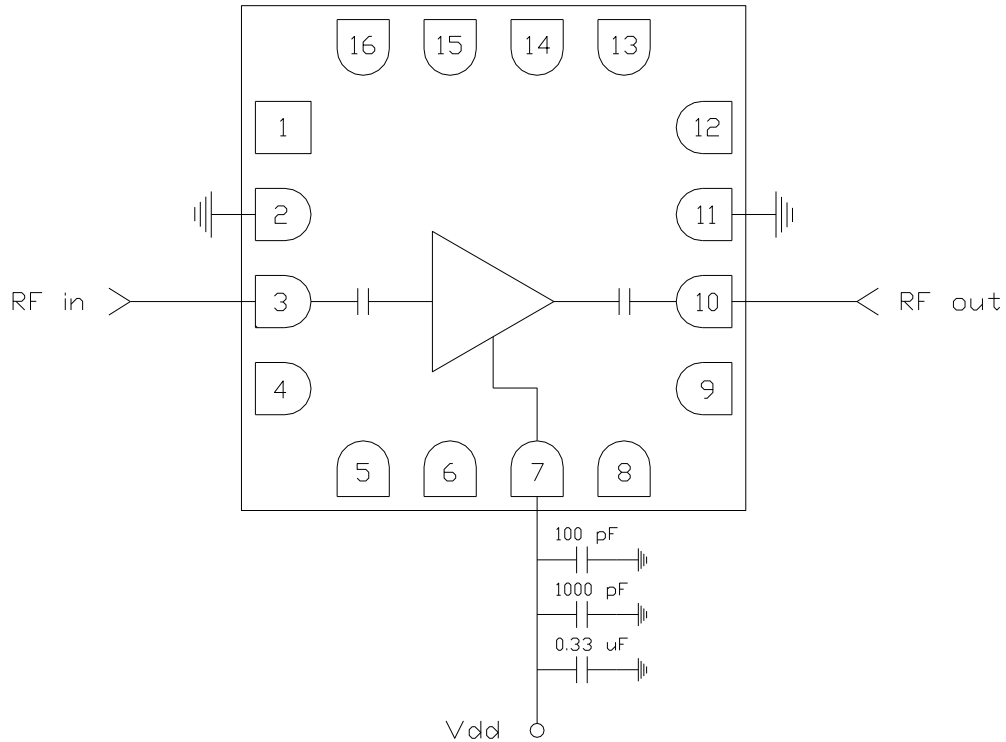

Biasing and Operation

The CMD231C3 is biased with a single positive drain supply. Performance is optimized when the drain voltage is set between +5.0 V and +8.0 V.

Turn ON procedure:

1. Apply drain voltage V_{dd} and set to +8 V

Turn OFF procedure:

1. Turn off drain voltage V_{dd}

RF power can be applied at any time.

GaAs MMIC devices are susceptible to damage from Electrostatic Discharge. Proper precautions should be observed during handling, assembly and test.

Applications Information

Evaluation Board

The circuit board shown has been developed for optimized assembly at Qorvo. A sufficient number of via holes should be used to connect the top and bottom ground planes. As surface mount processes vary, careful process development is recommended.

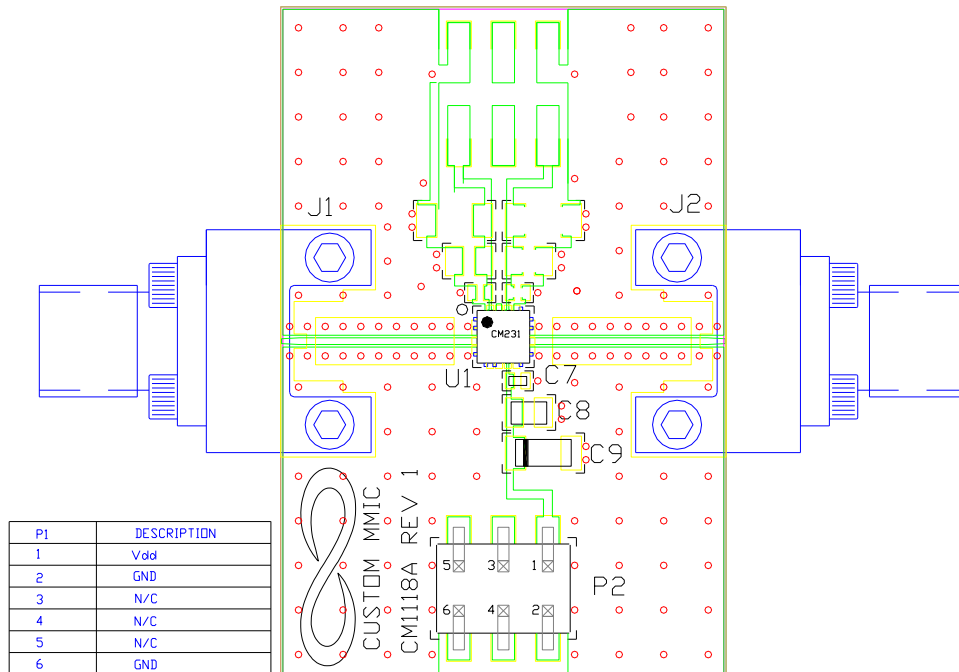

Bill of Material

Designator	Value	Description
J1, J2		SMA End Launch Connector
P2		6 Pin Header
C9	0.33 μ F	Capacitor, Tantalum
C8	1000 pF	Capacitor, 0603
C7	100 pF	Capacitor, 0402
U1		CMD231C3 Low Noise Amplifier
PCB		CM1118A Evaluation PCB