



CMD240C4

DC-22 GHz Distributed Amplifier

Features

- ▶ Ultra wideband performance
- ▶ Low noise figure
- ▶ Low current consumption
- ▶ Excellent return losses
- ▶ Pb-free RoHs compliant 4x4 QFN package

Description

The CMD240C4 is wideband GaAs MMIC distributed amplifier housed in a leadless 4x4 mm surface mount package. The amplifier operates from DC to 22 GHz and delivers greater than 15 dB of gain with a corresponding noise figure of 2 dB and output 1 dB compression point of +19 dBm at 10 GHz. The CMD240C4 is a 50 ohm matched design which eliminates the need for RF port matching.

Functional Block Diagram

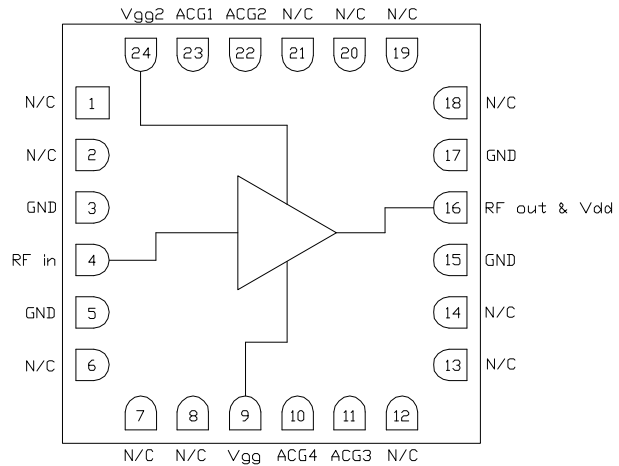

Note: Vgg2 is optional for gain control

Electrical Performance - $V_{dd} = 5.0\text{ V}$, $I_{dd} = 80\text{ mA}$, $T_A = 25\text{ }^\circ\text{C}$, $F = 10\text{ GHz}$

Parameter	Min	Typ	Max	Units
Frequency Range	DC - 22			GHz
Gain		15		dB
Noise Figure		2		dB
Input Return Loss		15		dB
Output Return Loss		13		dB
Output P1dB		19		dBm
Output IP3		27		dBm
Output IP2		27		dBm
Supply Current		80		mA

ver 1.2 0819



CMD240C4

DC-22 GHz Distributed Amplifier

Specifications

Absolute Maximum Ratings

Parameter	Rating
Drain Voltage, V _{dd}	4.5 to 10 V
Gate Voltage, V _{gg}	-2.5 to 0 V
RF Input Power	+20 dBm
Channel Temperature, T _{ch}	150 °C
Power Dissipation, P _{diss}	1.7 W
Thermal Resistance, Θ_{JC}	38 °C/W
Operating Temperature	-40 to 85 °C
Storage Temperature	-55 to 150 °C

Exceeding any one or combination of the maximum ratings may cause permanent damage to the device.

Recommended Operating Conditions

Parameter	Min	Typ	Max	Units
V _{dd}	5.0	5.0	8.0	V
I _{dd}		80		mA
V _{gg}		-0.6		V

Electrical performance is measured at specific test conditions. Electrical specifications are not guaranteed over all recommended operating conditions.

Electrical Specifications, V_{dd} = 5.0 V, I_{dd} = 80 mA, T_A = 25 °C

Parameter	Min	Typ	Max	Min	Typ	Max	Units
Frequency Range	DC - 22			6 - 18			GHz
Gain	12	15		12	16		dB
Noise Figure		2.5			2.2		dB
Input Return Loss		15			15		dB
Output Return Loss		13			13		dB
Output P1dB	13	19		15	19		dBm
Output IP3		26			26		dBm
Output IP2		30			30		dBm
Supply Current	55	80	105	55	80	105	mA
Gain Temperature Coefficient		0.01			0.01		dB/°C
Noise Figure Temperature Coefficient		0.01			0.01		dB/°C

ver 1.2 0819

Typical Performance

Broadband Performance, $V_{dd} = 5\text{ V}$, $I_{dd} = 80\text{ mA}$, $T_A = 25\text{ }^\circ\text{C}$

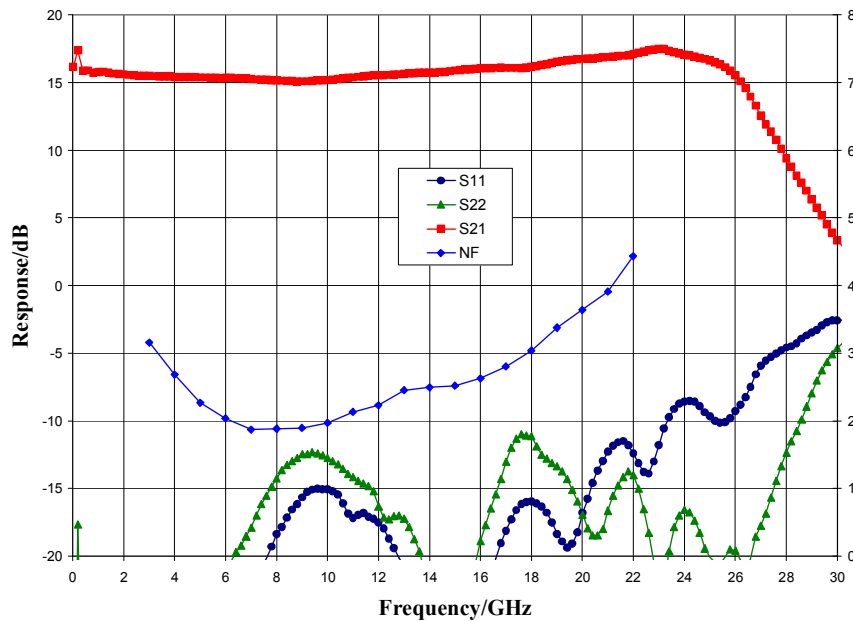

Narrow-band Performance, $V_{dd} = 5\text{ V}$, $I_{dd} = 80\text{ mA}$, $T_A = 25\text{ }^\circ\text{C}$

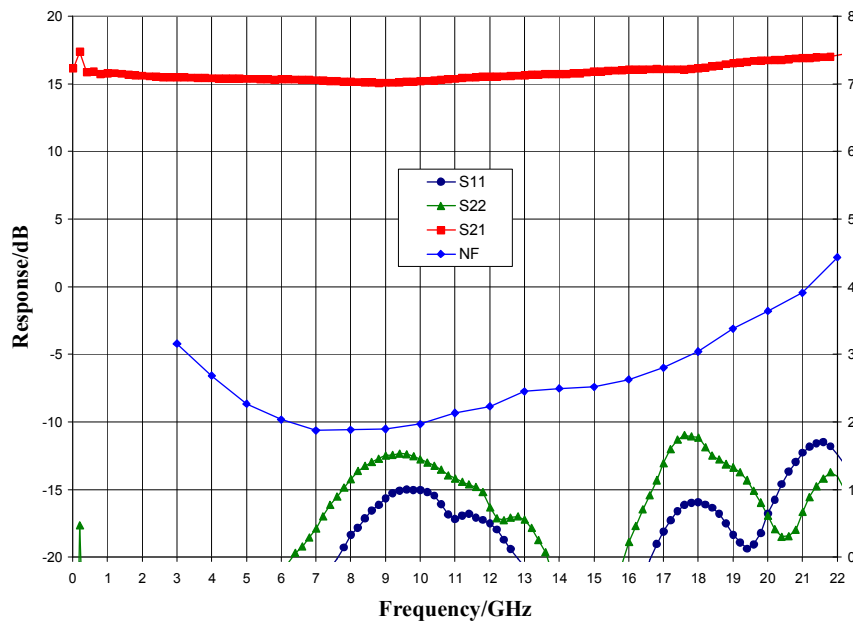

ver 1.2 0819

Typical Performance

Gain vs. Temperature, $V_{dd} = 5\text{ V}$

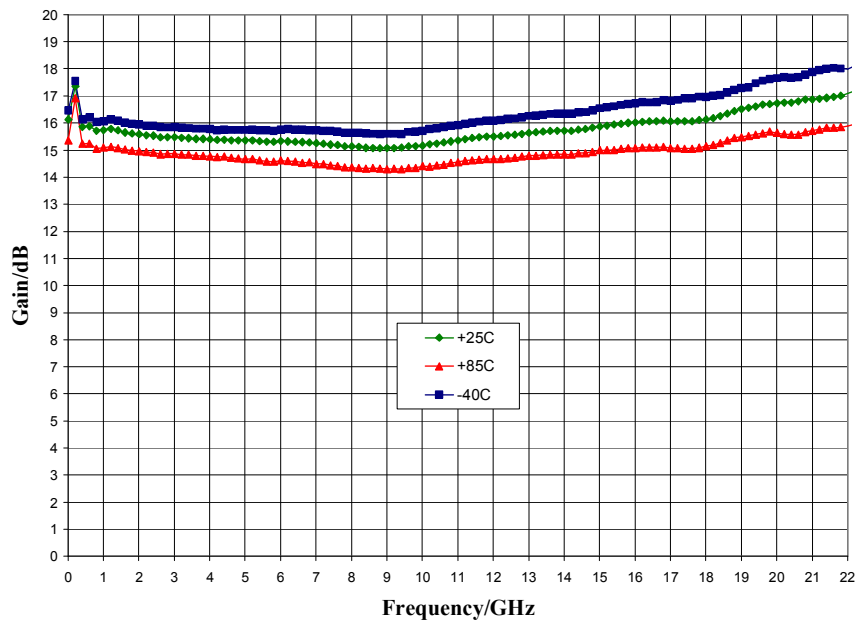

Noise Figure vs. Temperature, $V_{dd} = 5\text{ V}$

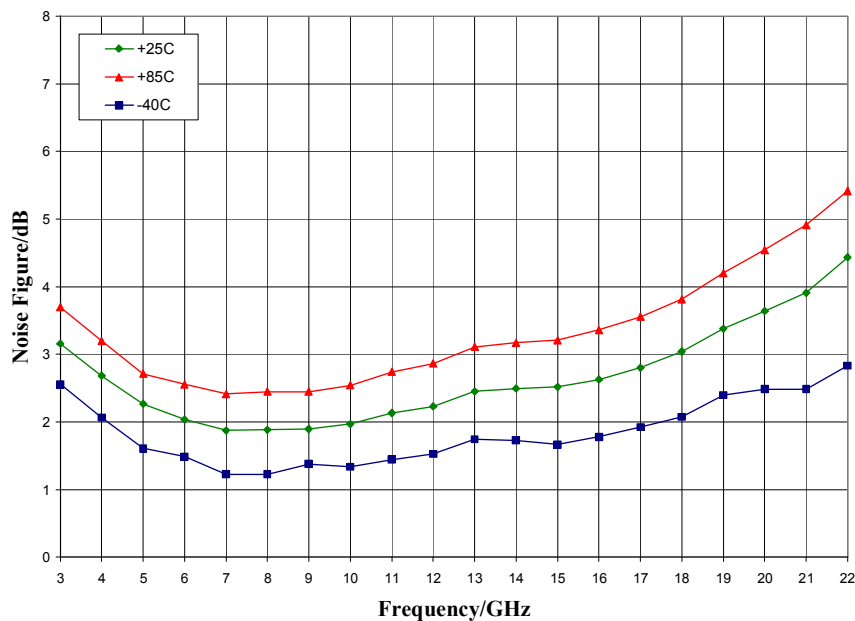

Typical Performance

Output Power, $V_{dd} = 5\text{ V}$, $T_A = 25\text{ }^\circ\text{C}$

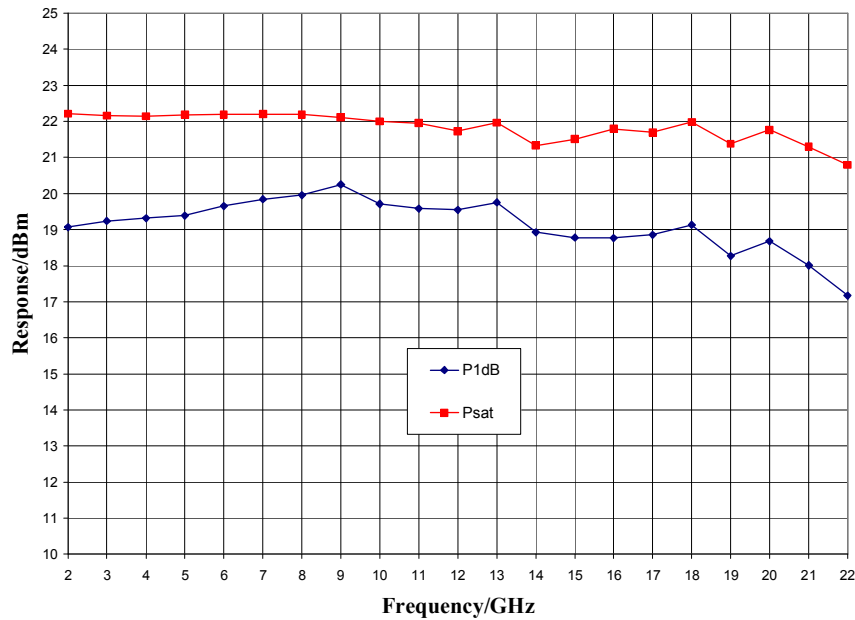

P1dB vs. Temperature, $V_{dd} = 5\text{ V}$

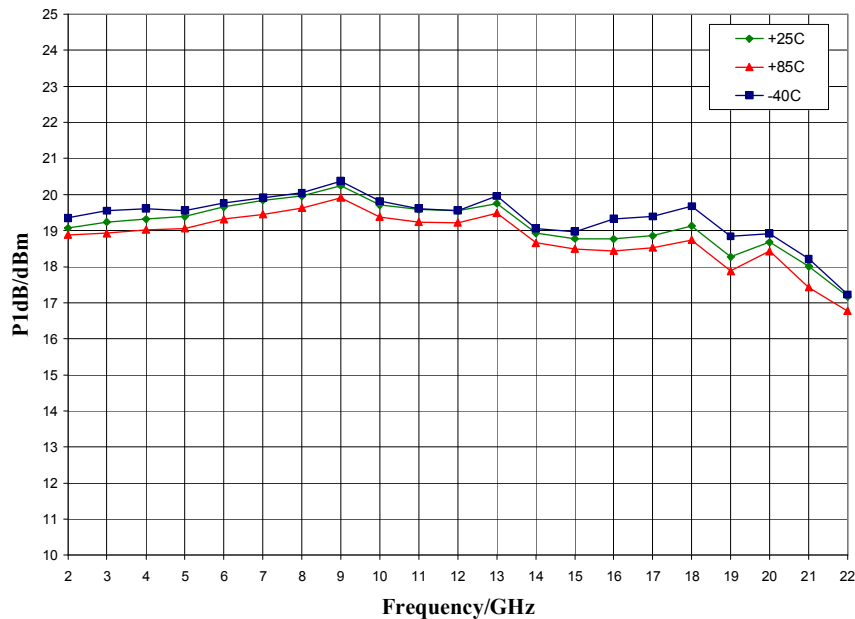

Typical Performance

Output IP3 vs. Temperature, $V_{dd} = 5\text{ V}$

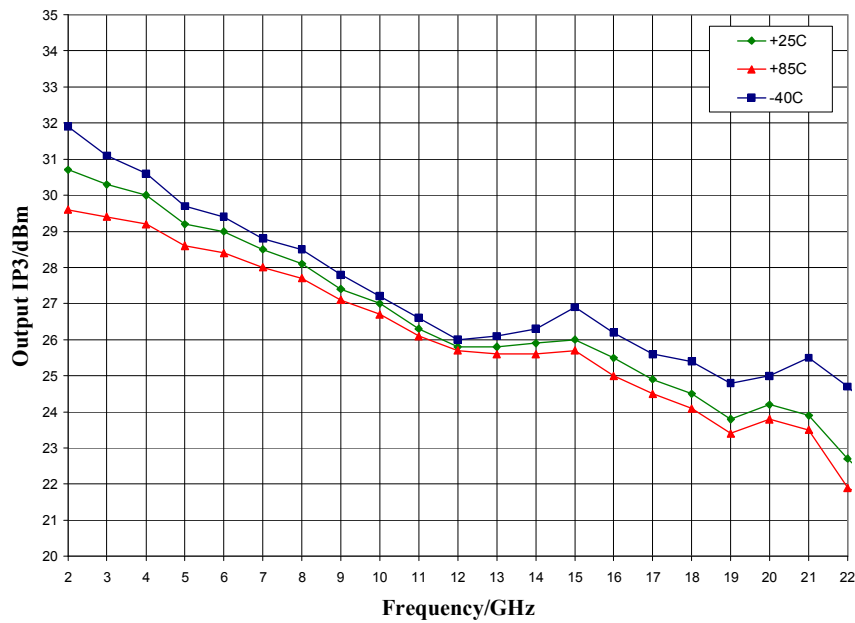

Output IP2, $V_{dd} = 5\text{ V}$, $T_A = 25\text{ }^\circ\text{C}$

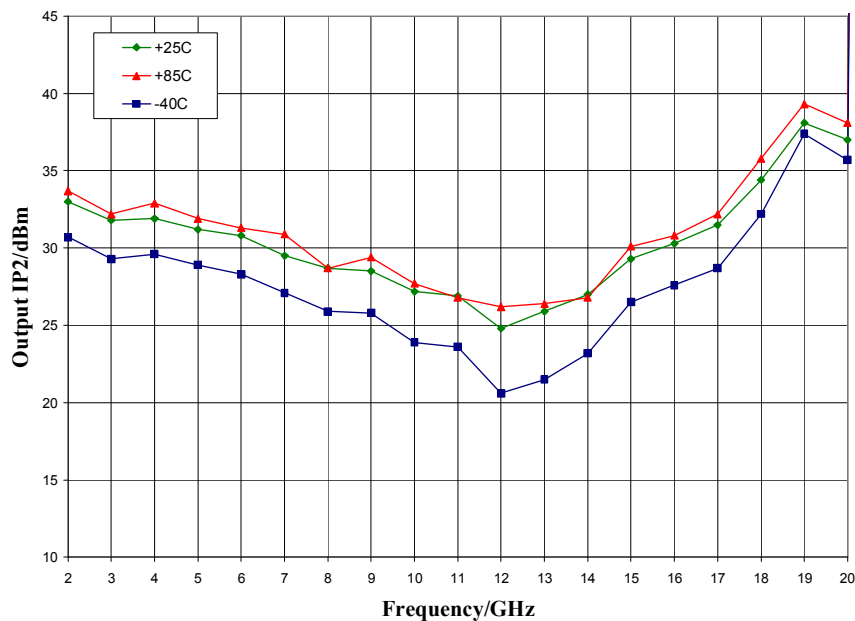

Mechanical Information

Package Information and Dimensions

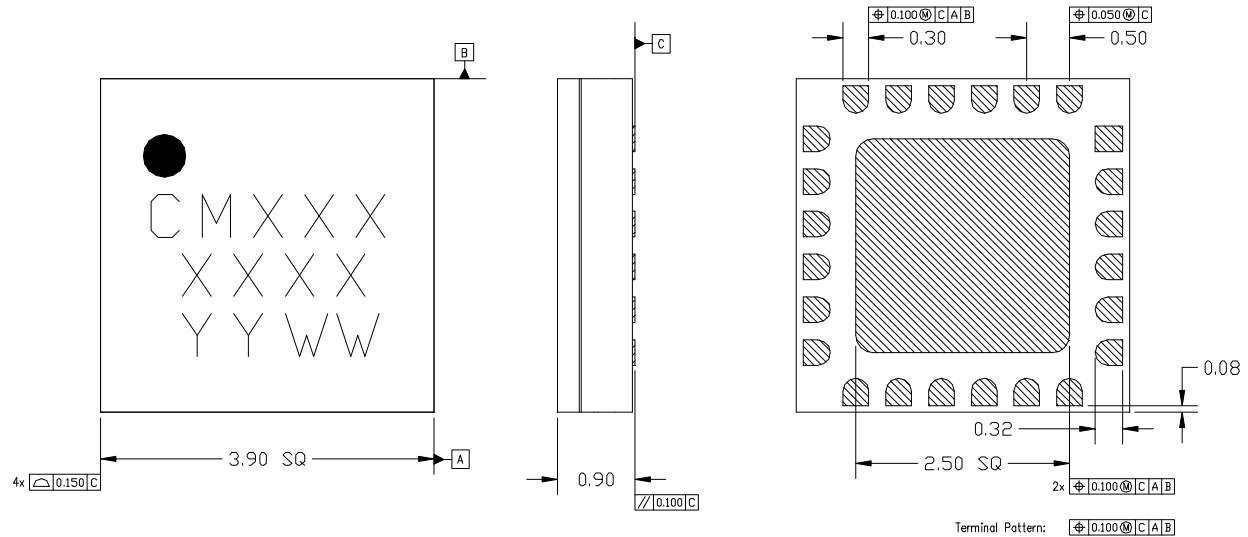

NOTES:

1. ALL DIMENSIONS SHOWN IN mm.
2. MATERIAL: BLACK ALUMINA
3. LEAD FINISH:
 - 3.1. Ni: 8.89um MAX, 1.27um MIN
 - 3.2. Pd: 0.17um MAX, 0.07um MIN
 - 3.3. Au: 0.254um MAX, 0.03um MIN
4. MARKING
 - 4.1. LINE 1: PART NUMBER
 - 4.1.1. EXAMPLE: CMD191C4 SHALL BE MARKED AS CM191
 - 4.2. LINE 2: LOT NUMBER
 - 4.3. LINE 3: DATE CODE - LAST 2 DIGITS OF THE YEAR OF MANUFACTURE FOLLOWED BY A 2 DIGIT WEEK CODE
5. ALTERNATE PIN #1 IDENTIFIER IS A SINGLE SQUARE PAD
6. ALTERNATE DIE PADDLE MAY HAVE CHAMFERED CORNERS

Recommended PCB Land Pattern

Custom MMIC Design Services recommends that the user develop the land pattern that will provide the best design for proper solder reflow and device attach for their specific application. Please review Custom MMIC Application Note AN 105 for a recommended land pattern approach.

Recommended Solder Reflow Profile



Custom MMIC Design Services recommends screen printing with belt furnace reflow to ensure proper solder reflow and device attach. Please review Custom MMIC Application Note AN 102 for a recommended solder reflow profile.

Pin Description

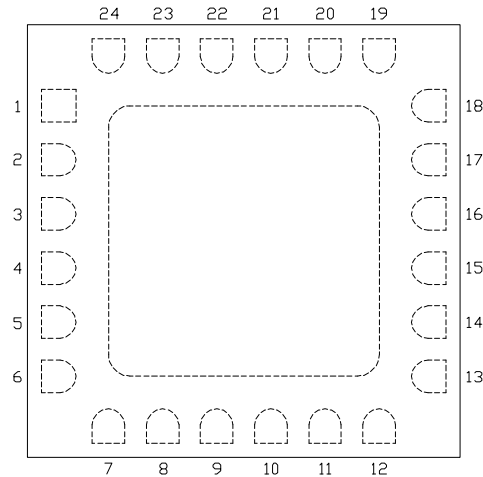
Pin Diagram

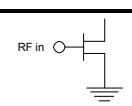
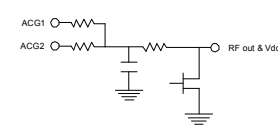
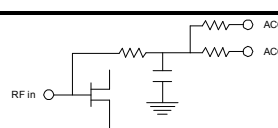
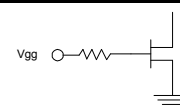
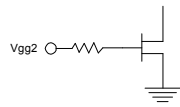

Functional Description

Pin	Function	Description	Schematic
1, 2, 6-8, 12-14, 18-21	N/C	No connection required. These pins may be connected to RF/DC ground	
4	RF in	50 ohm matched input	
22, 23	ACG2, 1	Low frequency termination. Attach bypass capacitors per application circuit	
16	RF out & Vdd	Power supply voltage and 50 ohm matched output	
10, 11	ACG4, 3	Low frequency termination. Attach bypass capacitors per application circuit	
9	Vgg	Power supply voltage Decoupling and bypass caps required	
24	Vgg2	Optional supply voltage for gain control. Decoupling and bypass caps required. Pin must be left open if unused.	
3, 5, 15, 17 and die paddle	Ground	Connect to RF / DC ground	

ver 1.2 0819

Applications Information

Evaluation Board

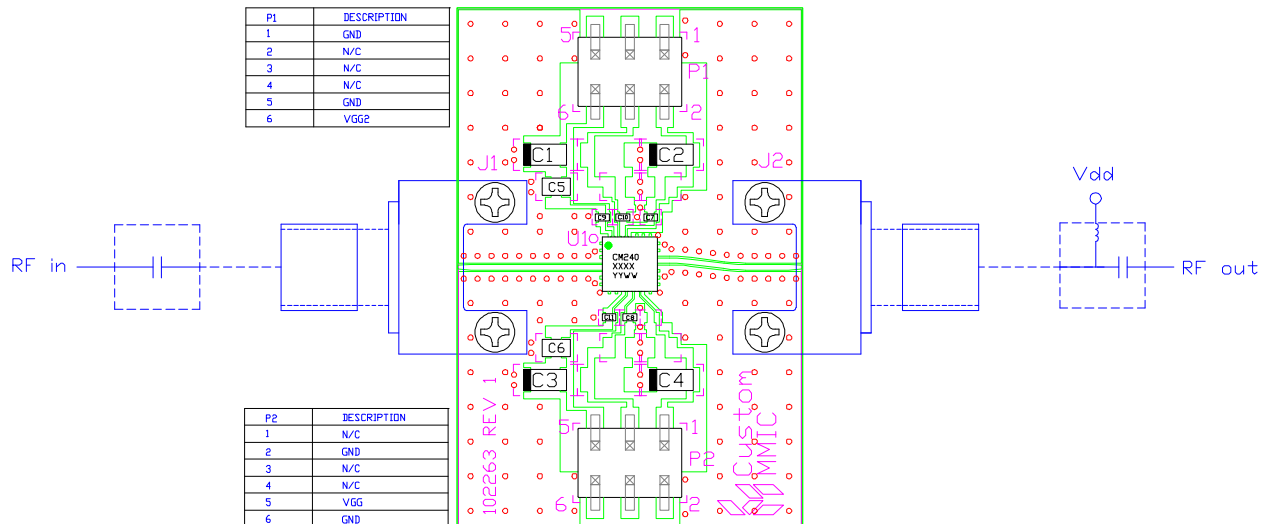

Bill of Material

Designator	Value	Description
J1, J2		SMA End Launch Connector
P1, P2		6 Pin DC Header
C1-C4	0.33 μ F	Capacitor, Tantalum
C5, C6	1000 pF	Capacitor, 0603
C7	100 pF	Capacitor, 0402
C8	22 pF	Capacitor, 0402
C9-C11	10 pF	Capacitor, 0402
U1		CMD240C4 Driver Amplifier
PCB		102263 Evaluation PCB

Please note, all information contained in this data sheet is subject to change without notice.

ver 1.2 0819