

### Features

- ▶ Low conversion loss
- ▶ High IP3
- ▶ Image rejection: 29 dB
- ▶ Wide IF bandwidth
- ▶ Pb-free RoHs compliant 4x4 mm SMT package

### Description

The CMD258C4 is a high IP3 I/Q mixer in a leadless surface mount package that can be used as either an image reject mixer or a single sideband upconverter. The CMD258C4 utilizes two double balanced mixer cells and a 90 degree hybrid. An external IF hybrid is needed to complete the image rejection. The CMD258C4 is a much smaller alternative to higher cost hybrid image reject mixers and single sideband upconverter assemblies.

### Functional Block Diagram

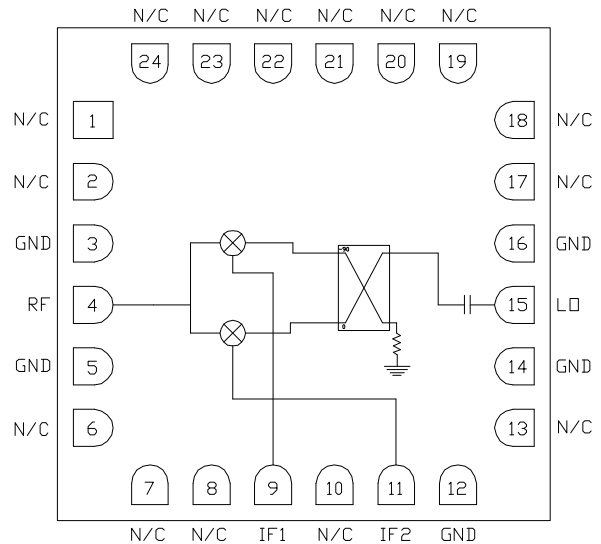

### Electrical Performance - IF = 100 MHz, LO = +21 dBm, T<sub>A</sub> = 25 °C, F = 10 GHz

Parameter	Min	Typ	Max	Units
Frequency Range, RF & LO	7.5 - 13			GHz
Frequency Range, IF	DC		3.5	GHz
Conversion Loss (as IRM)		5.5		dB
Image Rejection		29		dB
LO to RF Isolation		38		dB
LO to IF Isolation		20		dB
Input P1dB		14.5		dBm
Input IP3		25		dBm

Unless otherwise noted, all measurements performed as a downconverter, IF = 100 MHz

ver 1.0 1017



# CMD258C4

## 7.5-13 GHz High IP3 I/Q Mixer

### Specifications

#### Absolute Maximum Ratings

Parameter	Rating
RF / IF Input Power	+27 dBm
LO Drive	+27 dBm
Operating Temperature	-40 to 85 °C
Storage Temperature	-55 to 150 °C
Thermal Resistance, $\Theta_{JC}$	135.5 °C/W

Exceeding any one or combination of the maximum ratings may cause permanent damage to the device.

#### Electrical Specifications - IF = 100 MHz, LO = +21 dBm, T<sub>A</sub> = 25 °C

Parameter	Min	Typ	Max	Min	Typ	Max	Units
Frequency Range, RF & LO	9 - 11			7.5 - 13			GHz
Frequency Range, IF	DC		3.5	DC		3.5	GHz
Conversion Loss (as IRM)		5.5	7.5		7	10	dB
Image Rejection	23	28		23	30		dB
LO to RF Isolation	34	38		34	42		dB
LO to IF Isolation	15	19		14	20		dB
Input P1dB		15			16		dBm
Input IP3		24			24		dBm

Unless otherwise noted, all measurements performed as a downconverter, IF = 100 MHz

ver 1.0 1017

### Typical Performance

Data Taken As IRM With External IF Hybrid

Conversion Gain vs. Temperature, LO = +21 dBm, IF = 100 MHz USB

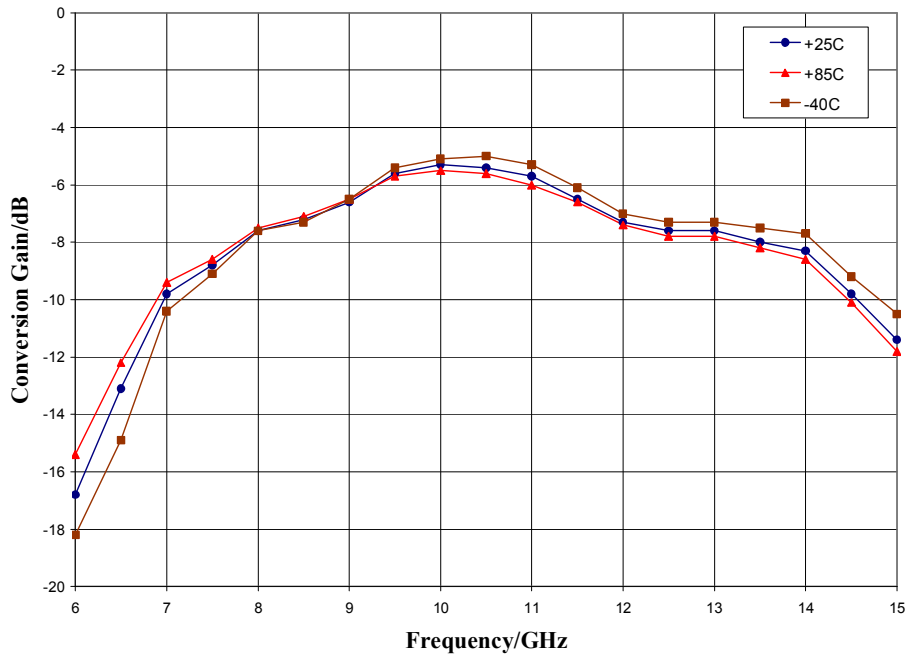

Conversion Gain vs. LO Drive, IF = 100 MHz USB

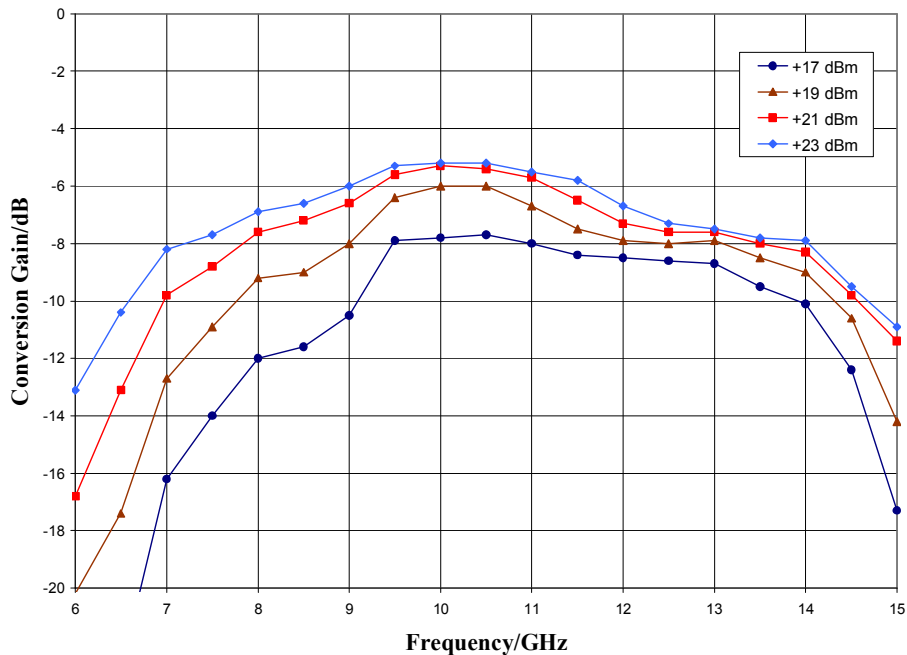

ver 1.0 1017

### Typical Performance

Data Taken As IRM With External IF Hybrid

Image Rejection, LO = +21 dBm, IF = 100 MHz USB

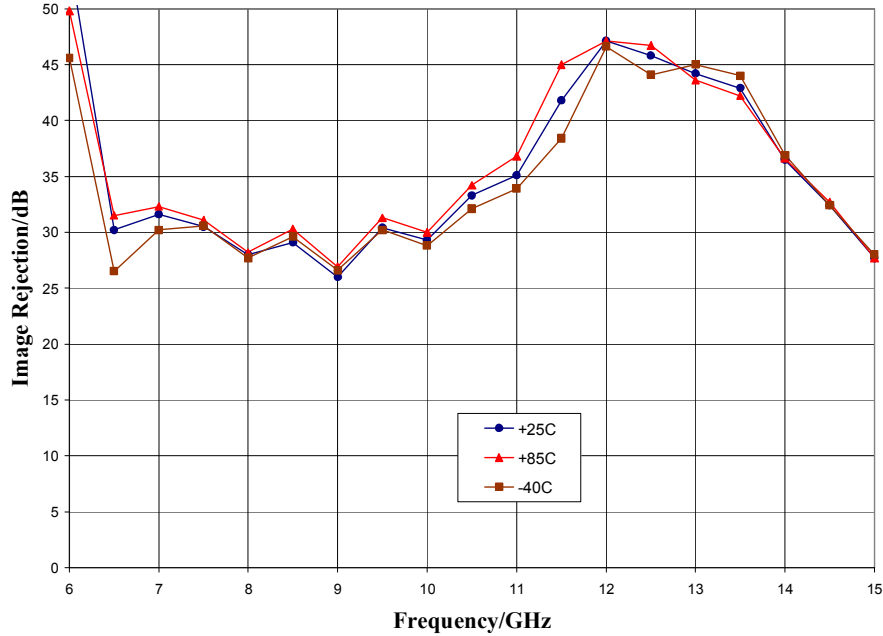

Return Loss, LO = +21 dBm

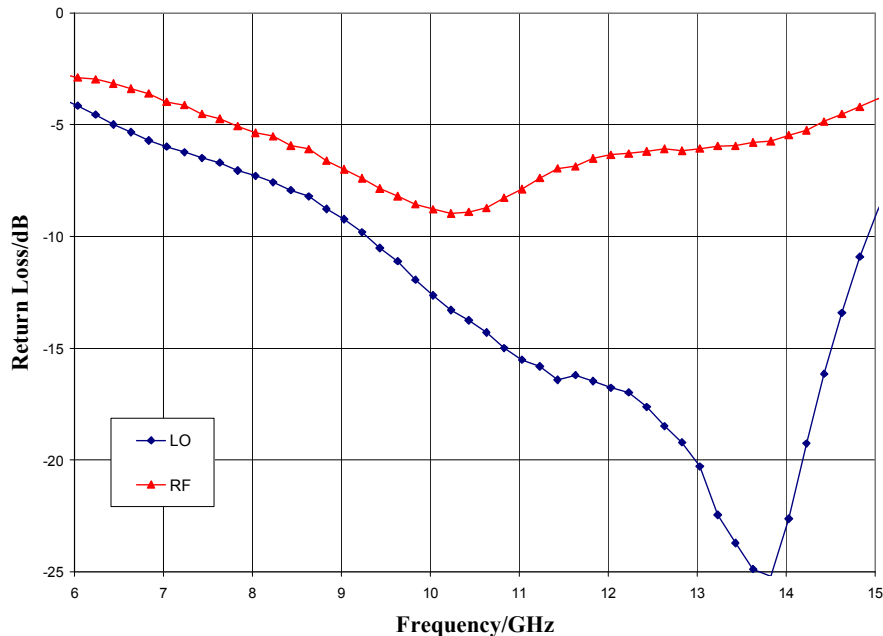

ver 1.0 1017

### Typical Performance

Data Taken As IRM With External IF Hybrid

Input P1dB vs. Temperature, LO = +21 dBm, IF = 100 MHz USB

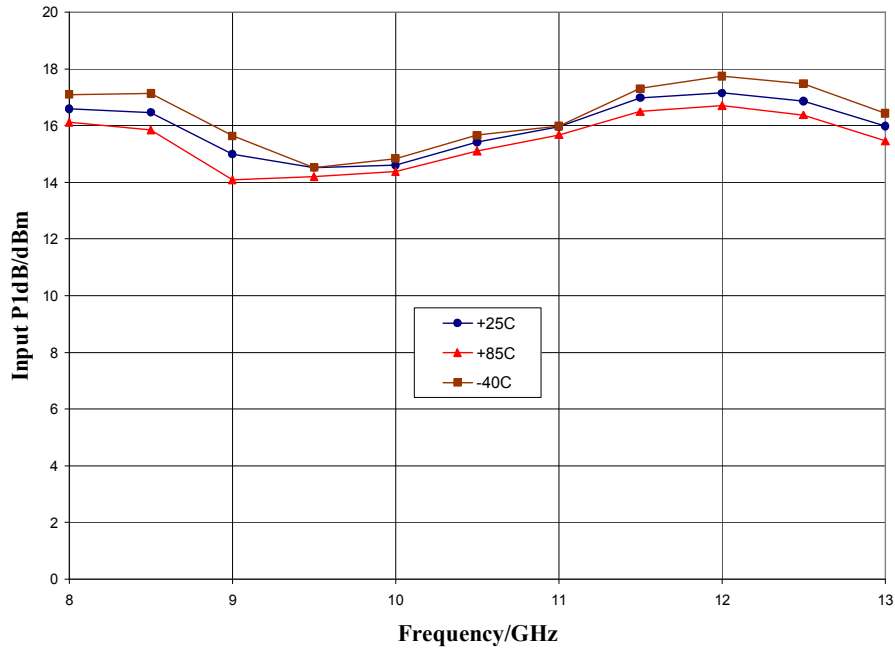

Input IP3 vs. Temperature, LO = +21 dBm, IF = 100 MHz USB

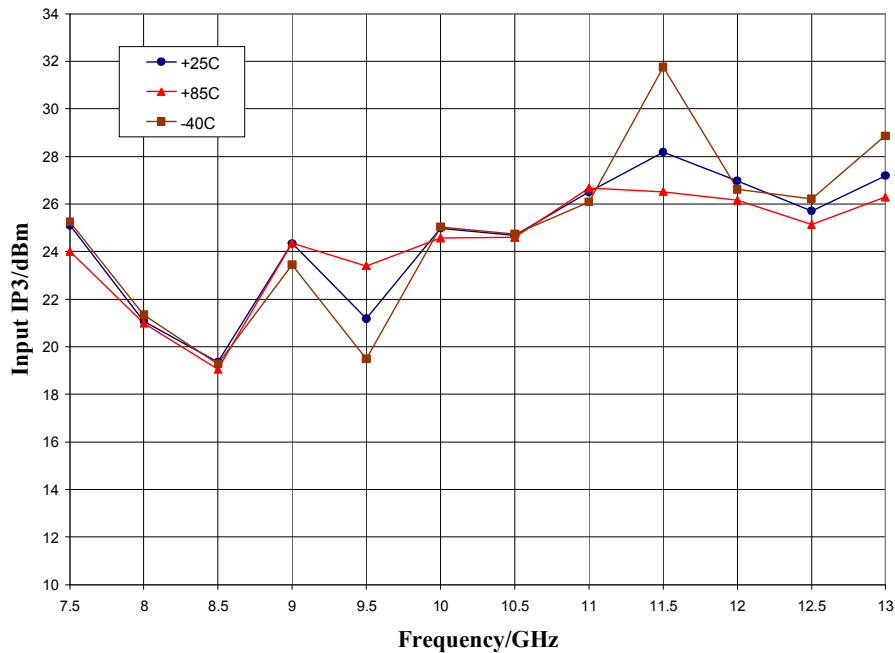

ver 1.0 1017

### Typical Performance

Data Taken As IRM With External IF Hybrid

Input IP3 vs. LO Drive, IF = 100 MHz USB

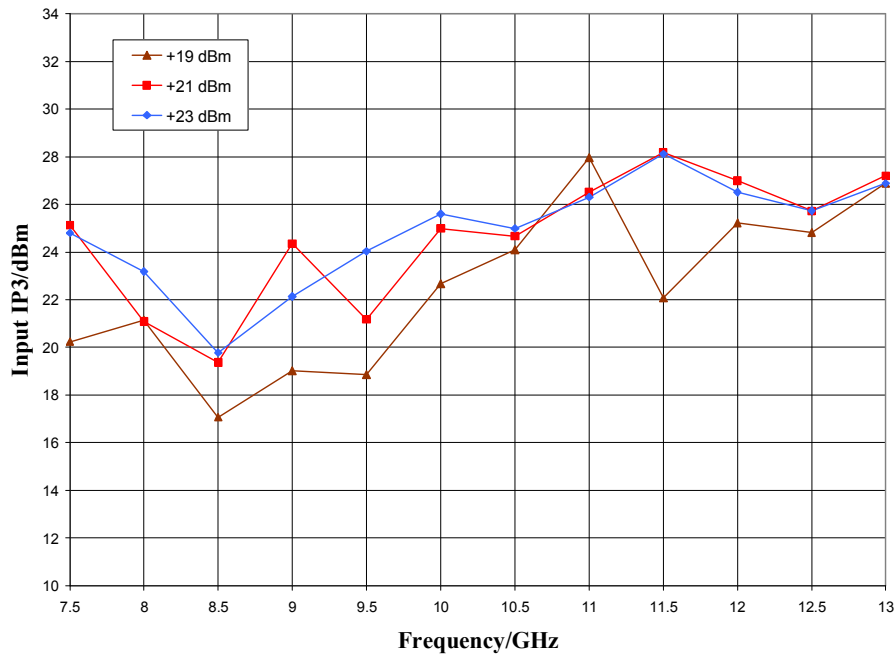

Upconverter Performance, Conversion Gain vs. LO Drive, IF = 950 MHz

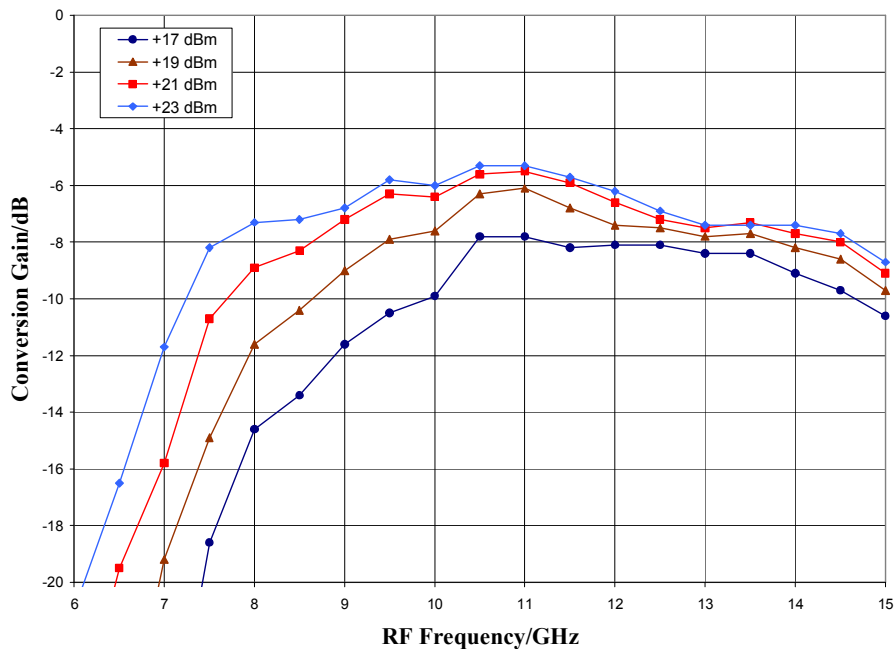

ver 1.0 1017

### Typical Performance

Data Taken As IRM With External IF Hybrid

Upconverter Performance, Input IP3 vs. LO Drive, IF = 100 MHz

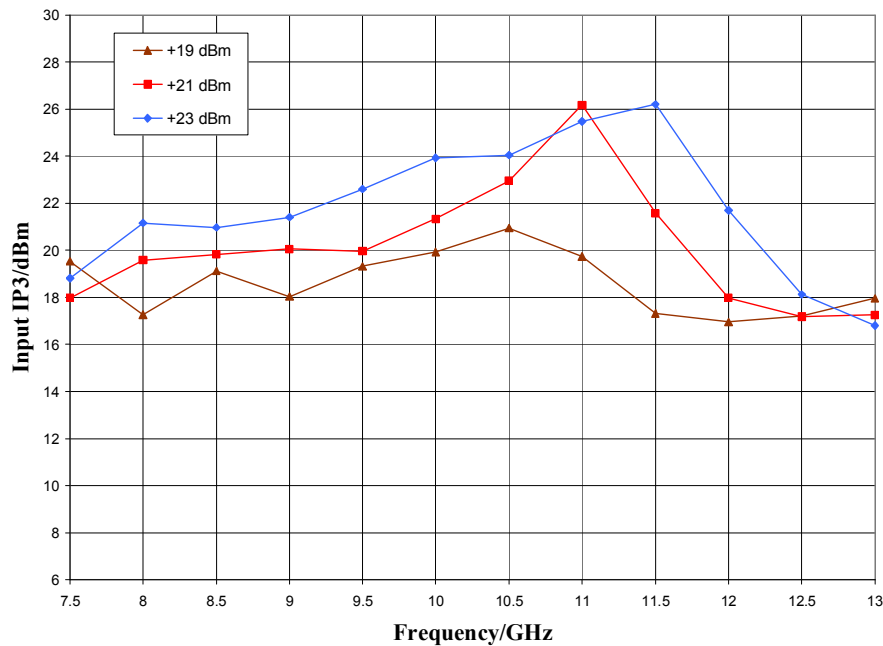

IF Bandwidth, LO = +21 dBm, Return Loss Data Taken Without IF Hybrid

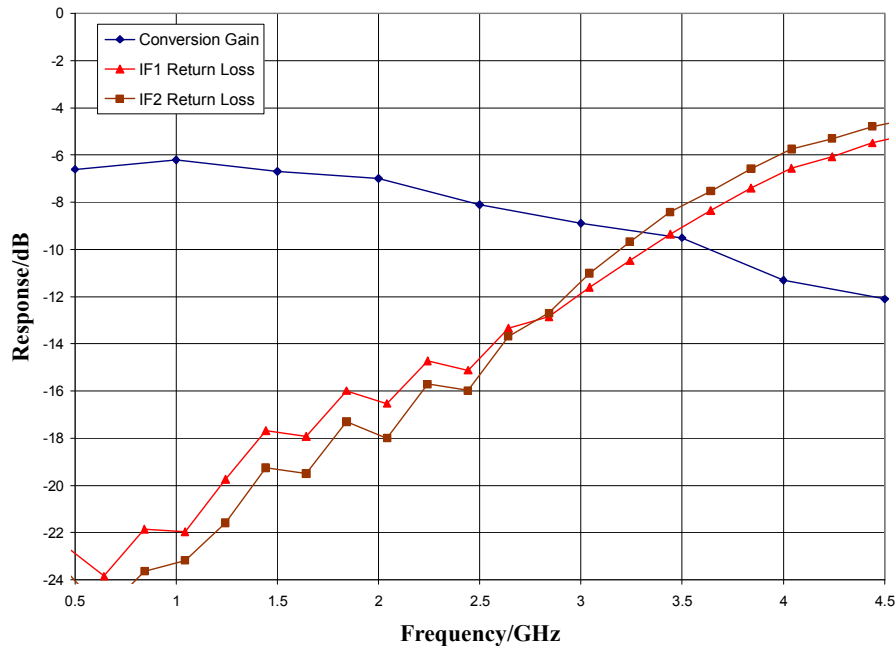

ver 1.0 1017

### Typical Performance

Isolation, LO = +21 dBm. Data Taken Without IF Hybrid

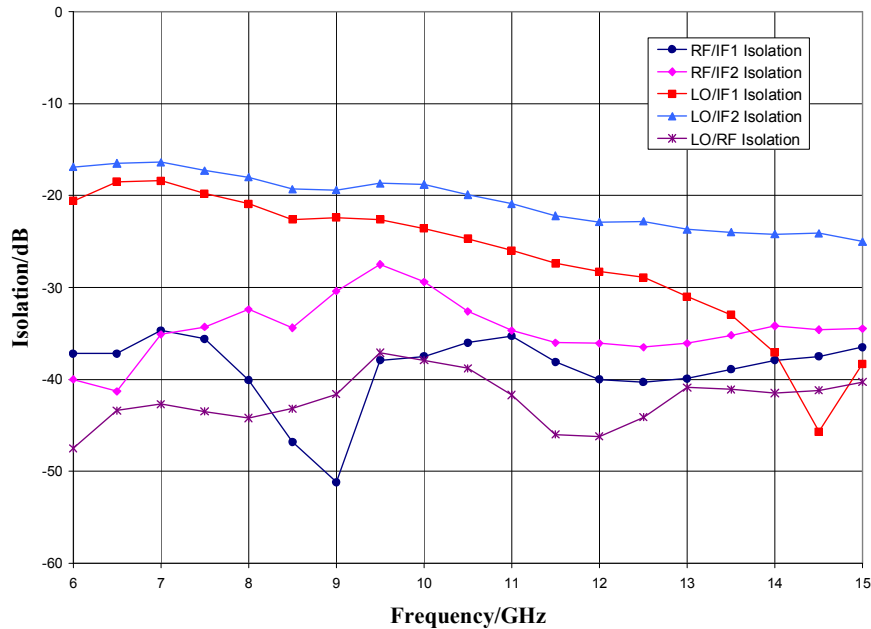

### MxN Spurious Outputs to IF1, IF2

mRF	nLO				
	0	1	2	3	4
0	xx	-13 / -17	35 / 29	-7 / 5	
1	28 / 27	0	31 / 34	51 / 56	51 / 59
2	> 71	60 / 59	> 71	> 71	> 71
3	> 71	> 71	> 71	> 71	> 71
4		> 71	> 71	> 71	> 71

RF = 10.6 GHz @ -10 dBm

LO = 10.5 GHz @ +21 dBm

All values in dBc below the IF1 / IF2 output power level (1RF - 1LO)

Measurement performed without IF hybrid

Where two numbers are listed, they are the spur levels for the IF1 / IF2 ports

ver 1.0 1017



### Mechanical Information

#### Package Information and Dimensions

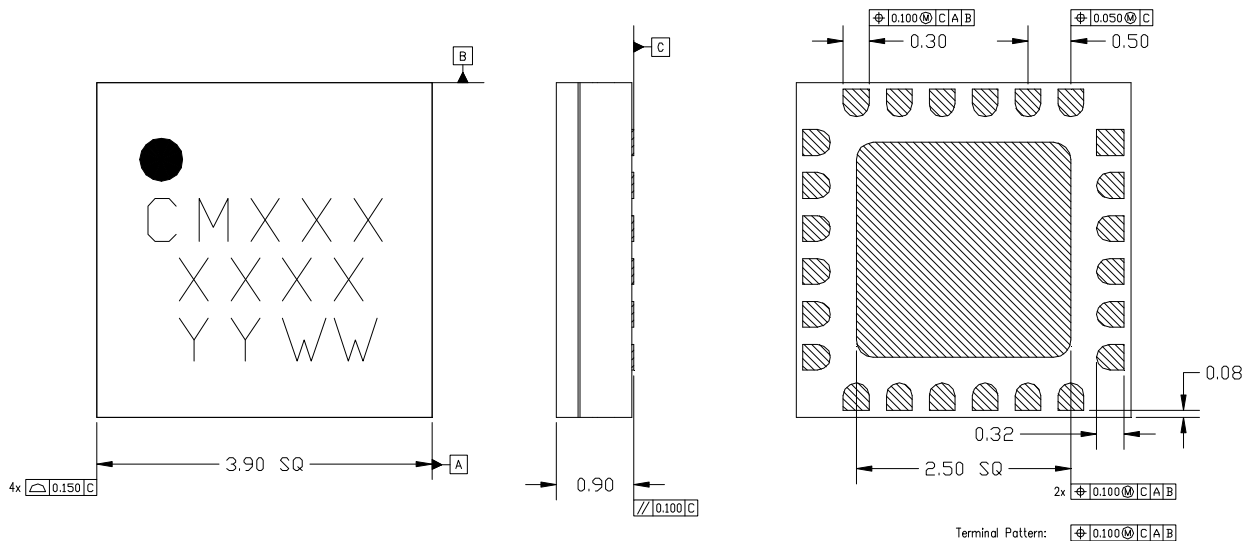

- NOTES:
1. ALL DIMENSIONS SHOWN IN mm.
  2. MATERIAL: BLACK ALUMINA
  3. LEAD FINISH:
    - 3.1. Ni: 8.89um MAX, 1.27um MIN
    - 3.2. Pd: 0.17um MAX, 0.07um MIN
    - 3.3. Au: 0.254um MAX, 0.03um MIN
  4. MARKING
    - 4.1. LINE 1: PART NUMBER
      - 4.1.1. EXAMPLE: CMD191C4 SHALL BE MARKED AS CM191
    - 4.2. LINE 2: LOT NUMBER
    - 4.3. LINE 3: DATE CODE - LAST 2 DIGITS OF THE YEAR OF MANUFACTURE FOLLOWED BY A 2 DIGIT WEEK CODE
  5. ALTERNATE PIN #1 IDENTIFIER IS A SINGLE SQUARE PAD
  6. ALTERNATE DIE PADDLE MAY HAVE CHAMFERED CORNERS

#### Recommended PCB Land Pattern

Custom MMIC Design Services recommends that the user develop the land pattern that will provide the best design for proper solder reflow and device attach for their specific application. Please review Custom MMIC Application Note AN 105 for a recommended land pattern approach.

#### Recommended Solder Reflow Profile



Custom MMIC Design Services recommends screen printing with belt furnace reflow to ensure proper solder reflow and device attach. Please review Custom MMIC Application Note AN 102 for a recommended solder reflow profile.

### Pin Description

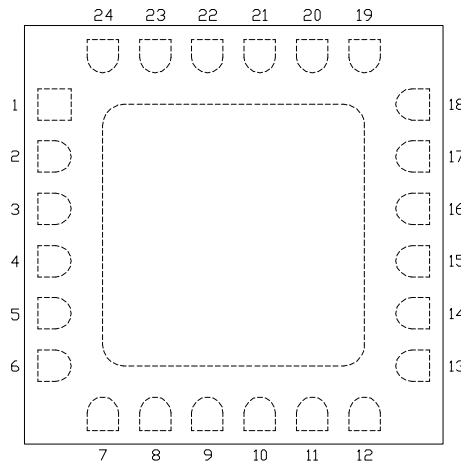
#### Pin Diagram

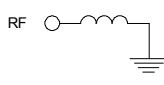
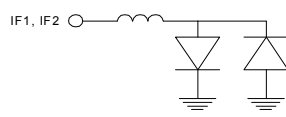

#### Functional Description

Pin	Function	Description	Schematic
1, 2, 6-8, 10, 13, 17-24	N/C	No connection required. These pins may be connected to RF/DC ground.	
3, 5, 12, 14, 16 and die paddle	Ground	Connect to RF / DC ground.	
4	RF	This pin is DC coupled and matched to 50 ohms.	
9	IF1	This pin is DC coupled. For applications not requiring operation to DC, this port should be DC blocked externally using a series capacitor whose value has been chosen to pass the necessary IF frequency range. For operation to DC, this pin must not source or sink more than 16 mA of current or part non-function or part failure may result.	
11	IF2		
15	LO	This pin is AC coupled and matched to 50 ohms.	

ver 1.0 1017