

Product Overview

The CMD291P4 is a wideband GaAs MMIC driver amplifier housed in a leadless 4x4 mm surface mount package. The broadband device operates from 16 to 24 GHz and is ideally suited for applications requiring high dynamic range. The CMD291P4 delivers 22 dB of gain with a corresponding output 1 dB compression point of +25.5 dBm and output IP3 of 31.5 dBm at 20 GHz. The amplifier is a 50 ohm matched design which eliminates the need for external DC blocks and RF port matching.

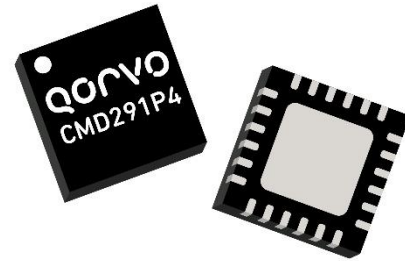

Functional Block Diagram

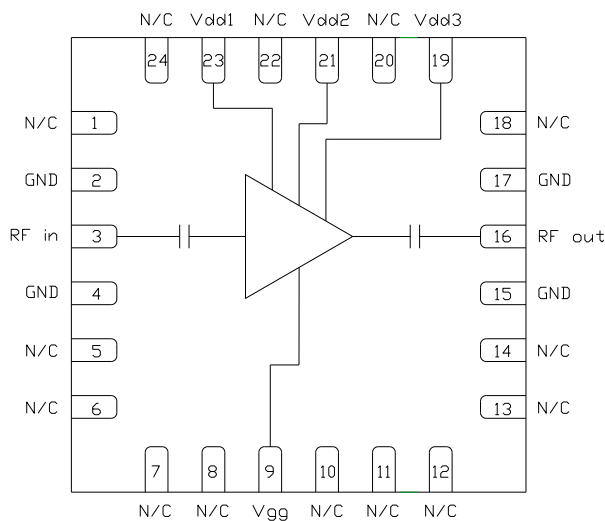

Key Features

- Wideband Performance
- High Gain
- High Linearity
- HMC498LC4 Replacement
- Pb-Free RoHs Compliant 4x4 QFN Package

Ordering Information

Part No.	Description
CMD291P4	100 pcs on 7" reel (standard)
CMD291P4-EVB	Evaluation Board

Electrical Performance ($V_{dd} = 5\text{ V}$, $I_{dd} = 250\text{ mA}$, $T_A = 25^\circ\text{ C}$, $F = 20\text{ GHz}$)

Parameter	Min	Typ	Max	Units
Frequency Range		16 - 24		GHz
Gain		22		dB
Noise Figure		5		dB
Input Return Loss		18		dB
Output Return Loss		13		dB
Output P1dB		25.5		dBm
Psat		26.5		dBm
Output IP3		31.5		dBm
Supply Current		250		mA

Absolute Maximum Ratings

Parameter	Rating
Drain Voltage, V_{dd}	5.75
Gate Voltage, V_{gg}	-2.5 V to 0 V
RF Input Power	+18 dBm
Channel Temperature, T_{ch}	150° C
Power Dissipation, P_{diss}	1.83 W
Thermal Resistance, Q_{JC}	35.5° C/W
Operating Temperature	-40 to 85° C
Storage Temperature	-55 to 150° C

Exceeding any one or combination of the maximum ratings may cause permanent damage to the device.

Recommended Operating Conditions

Parameter	Min	Typ	Max	Units
V_{dd}	3	5	5.5	V
I_{dd}		250		mA
V_{gg}		-0.5		V

Electrical performance is measured at specific test conditions. Electrical specifications are not guaranteed over all recommended operating conditions.

Electrical Specifications ($V_{dd} = 5\text{ V}$, $I_{dd} = 250\text{ mA}$, $T_A = 25^\circ\text{ C}$)

Parameter	Min	Typ	Max	Min	Typ	Max	Units
Frequency Range	16 - 20			20 - 24			GHz
Gain	19	22		19	22		dB
Noise Figure		5			5.5		dB
Input Return Loss		20			15		dB
Output Return Loss		15			13		dB
Output P1dB	22.5	25.5		22	25.5		dBm
P_{sat}		26.5			26		dBm
Output IP3		32.5			31		dBm
Supply Current	175	250	325	175	250	325	mA
Gain Temperature Coefficient		0.032			0.032		dB/°C
Noise Figure Temperature Coefficient		0.013			0.014		dB/°C

Typical Performance

Broadband Performance, $V_{dd} = 5\text{ V}$, $I_{dd} = 250\text{ mA}$, $T_A = 25^\circ\text{C}$

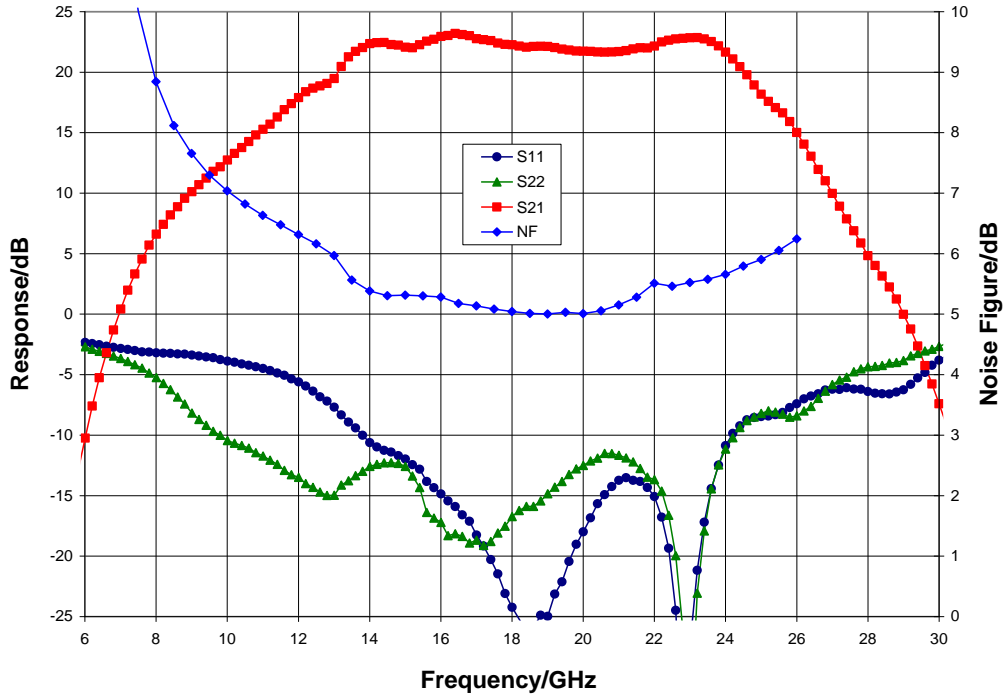

Narrow-band Performance, $V_{dd} = 5\text{ V}$, $I_{dd} = 250\text{ mA}$, $T_A = 25^\circ\text{C}$

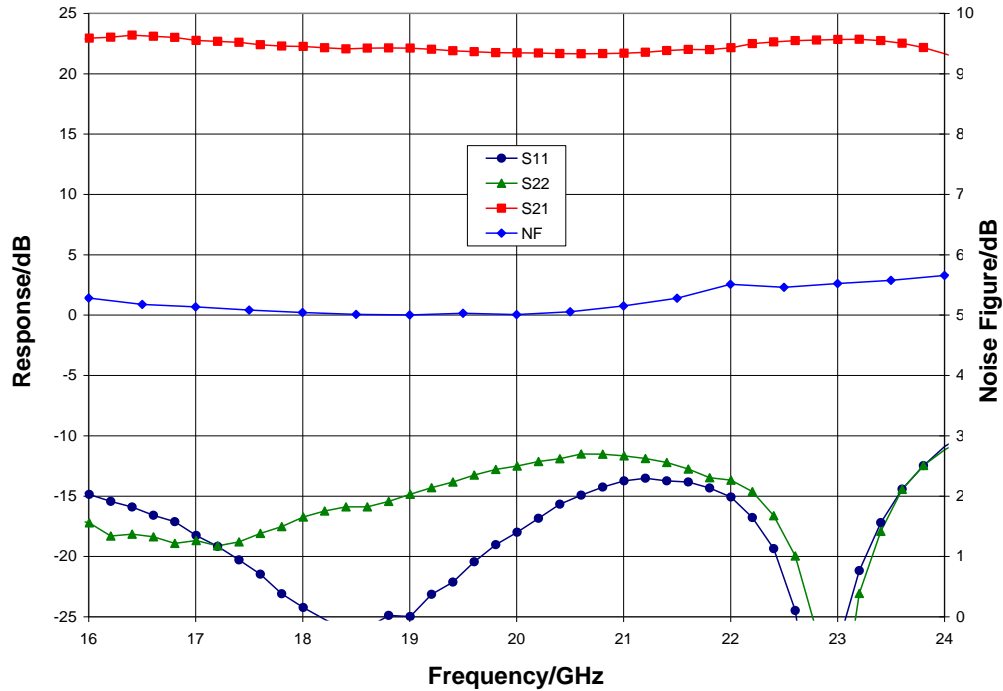

Typical Performance

Gain vs. Temperature, $V_{dd} = 5\text{ V}$

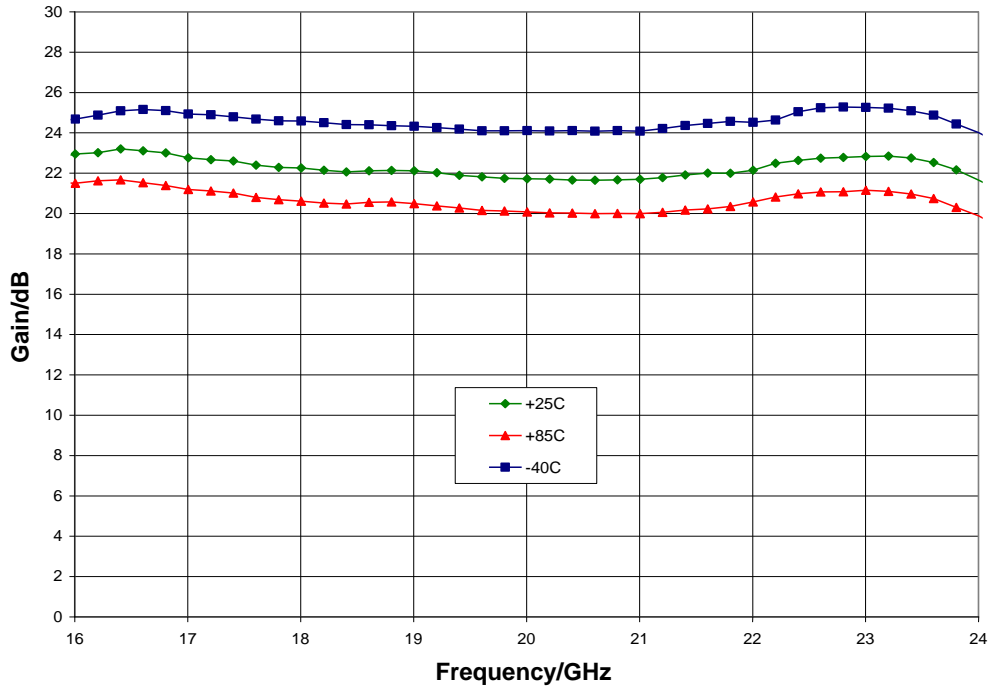

Gain vs. V_{dd} , $I_{dd} = 250\text{ mA}$, $T_A = 25^\circ\text{ C}$

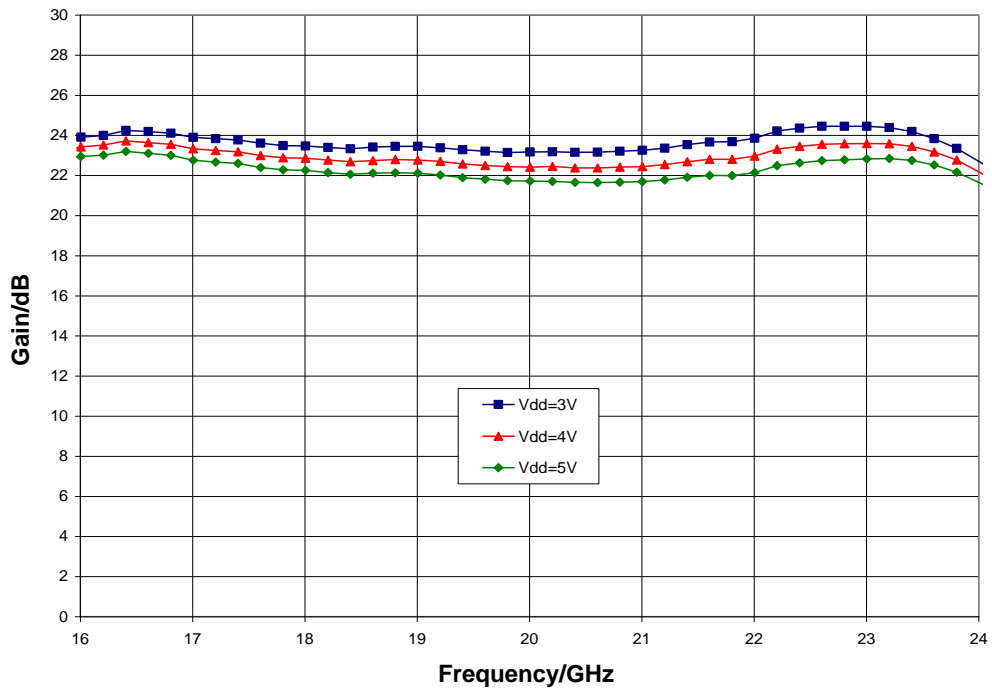

Typical Performance

Noise Figure vs. Temperature, $V_{dd} = 5\text{ V}$

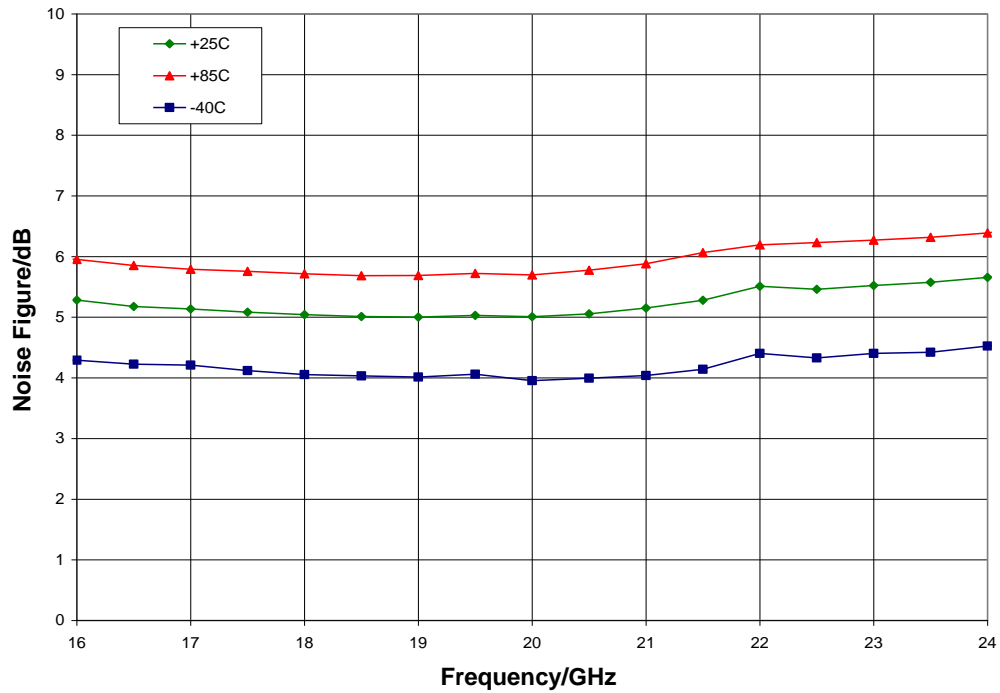

Noise Figure vs. V_{dd} , $I_{dd} = 250\text{ mA}$, $T_A = 25^\circ\text{ C}$

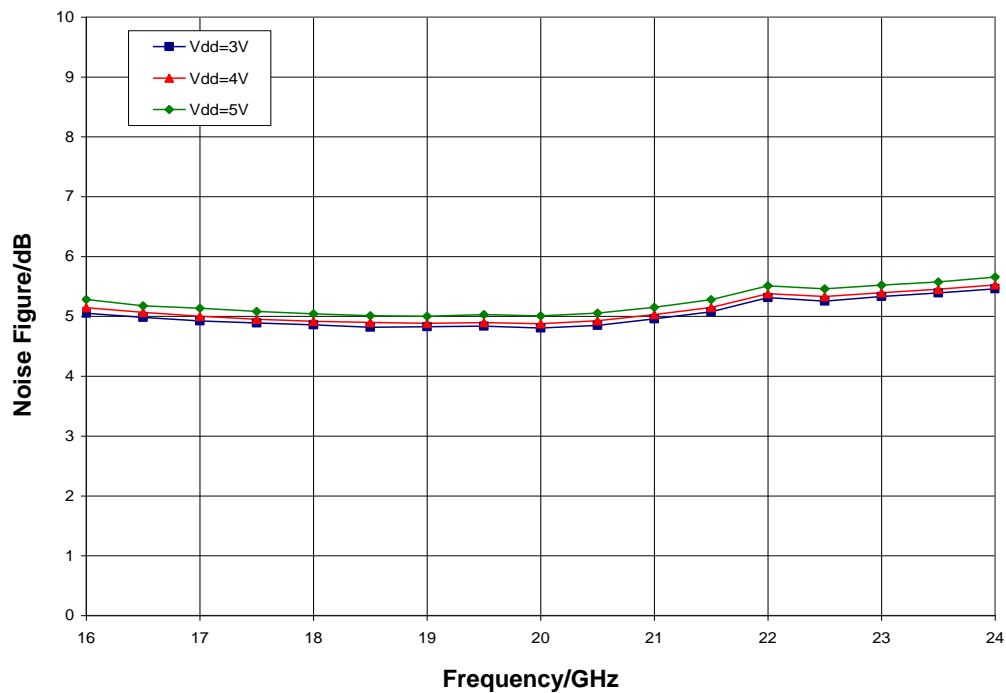

Typical Performance

P1dB vs. Temperature, $V_{dd} = 5\text{ V}$

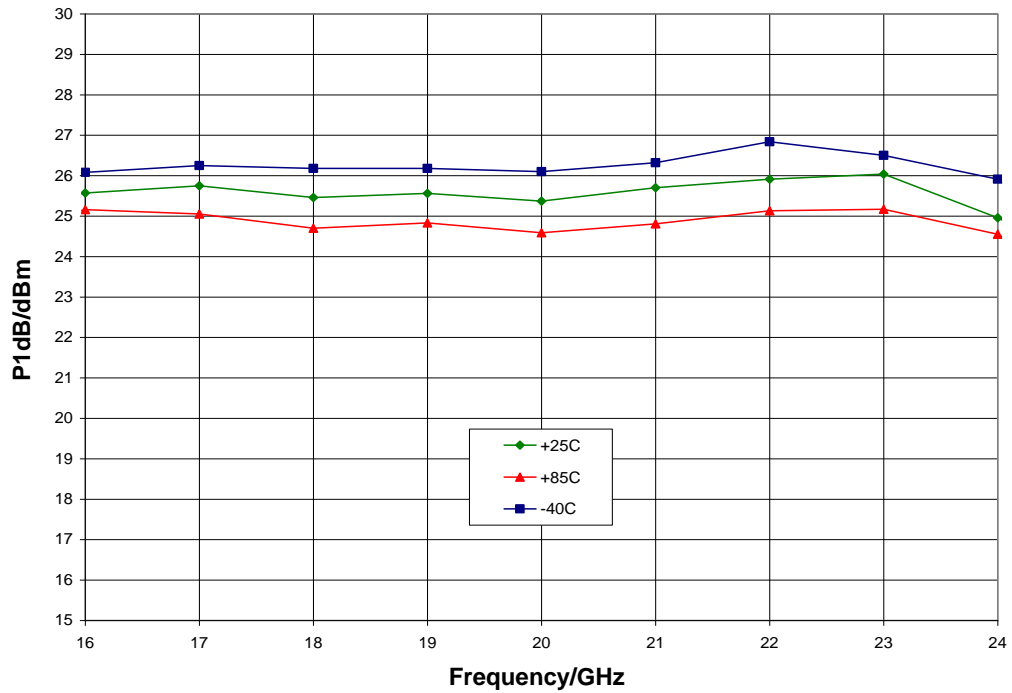

P1dB vs. V_{dd} , $I_{dd} = 250\text{ mA}$, $T_A = 25^\circ\text{C}$

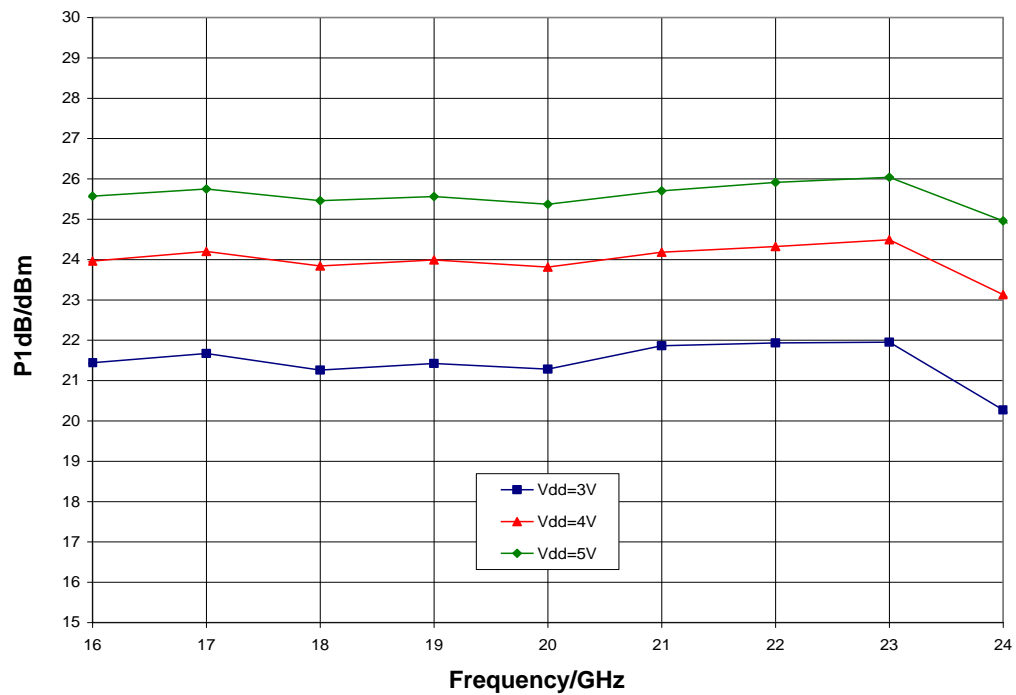

Typical Performance

Psat vs. Temperature, $V_{dd} = 5\text{ V}$

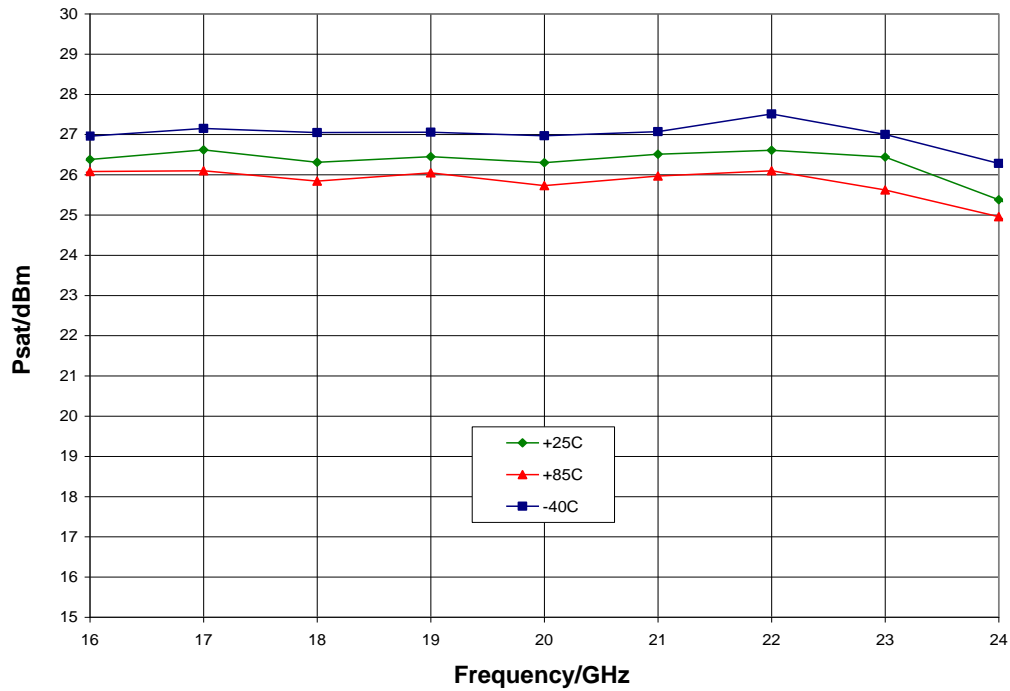

Psat vs. V_{dd} , $I_{dd} = 250\text{ mA}$, $T_A = 25^\circ\text{C}$

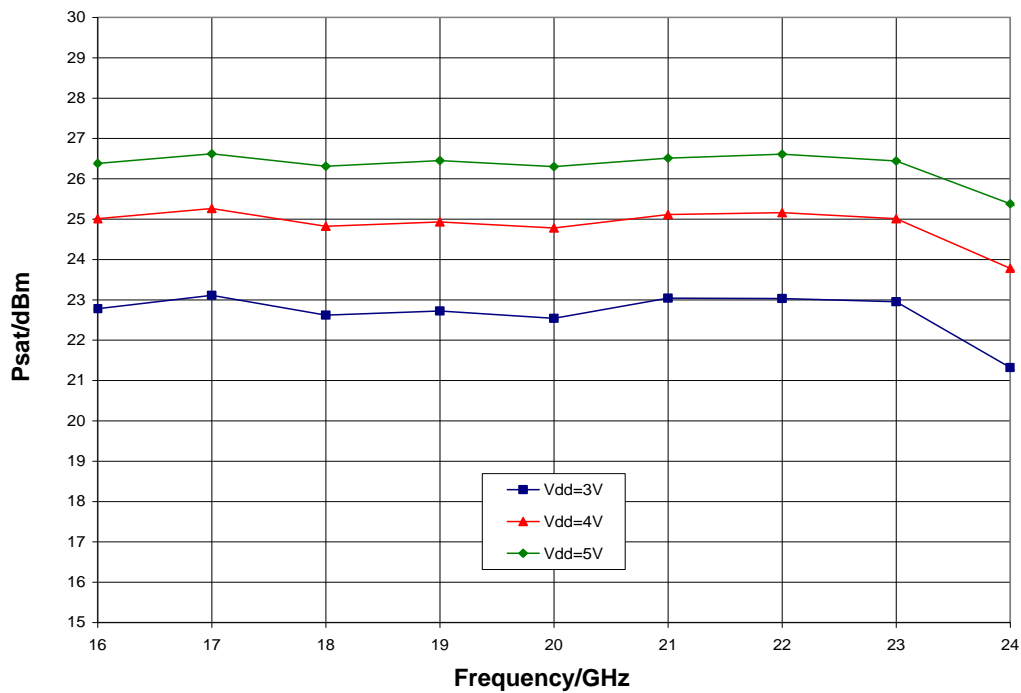

Typical Performance

Output IP3 vs. Temperature, $V_{dd} = 5\text{ V}$

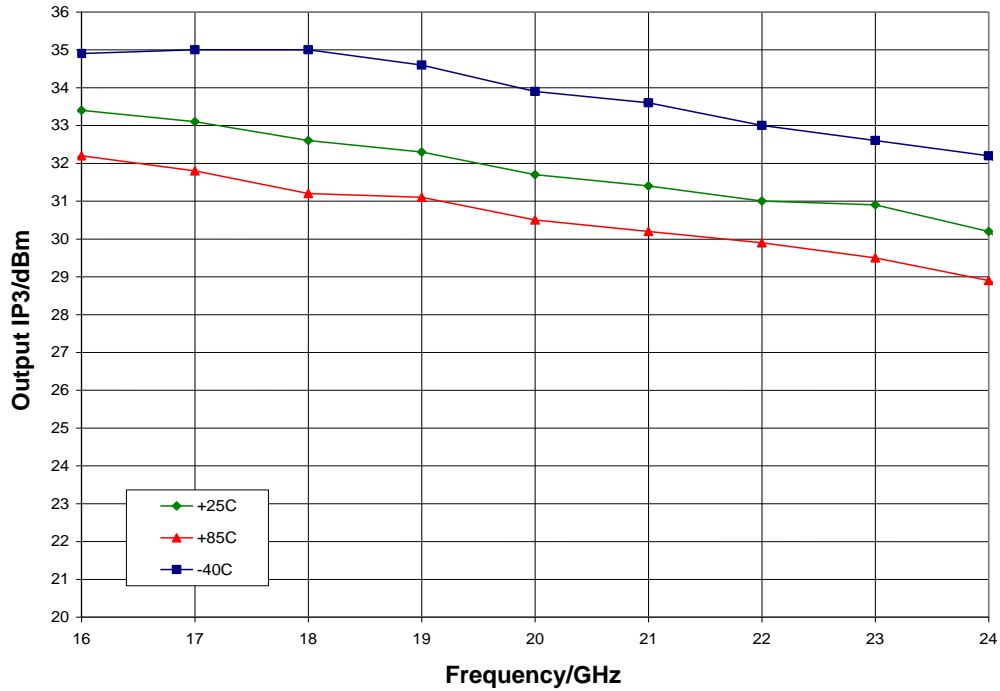

Output IP3 vs. V_{dd} , $I_{dd} = 250\text{ mA}$, $T_A = 25^\circ\text{ C}$

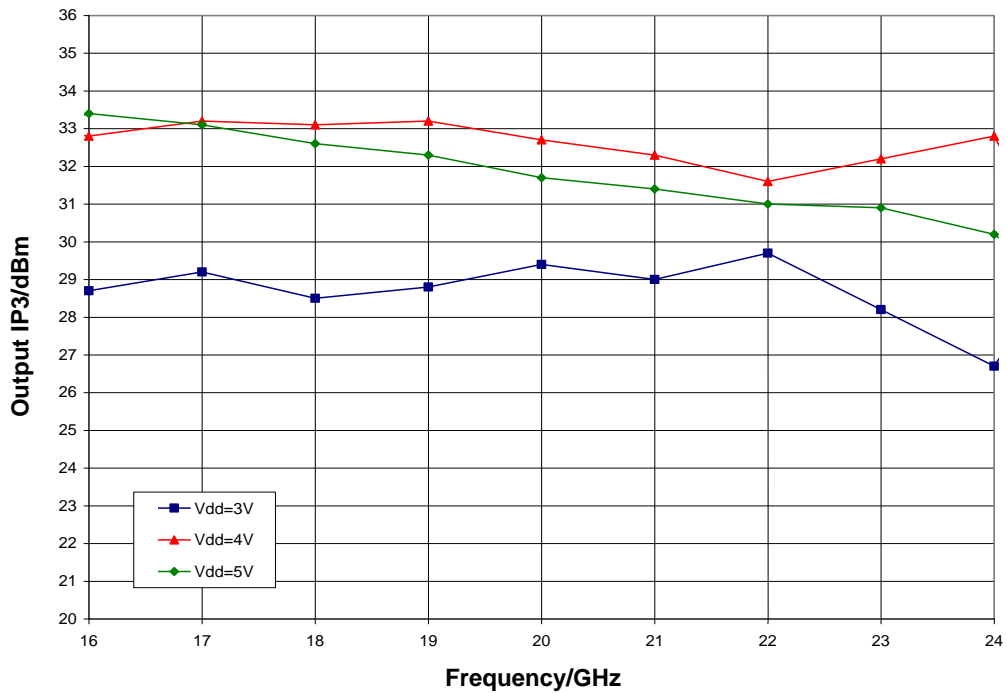

Mechanical Information

Package Information and Dimensions

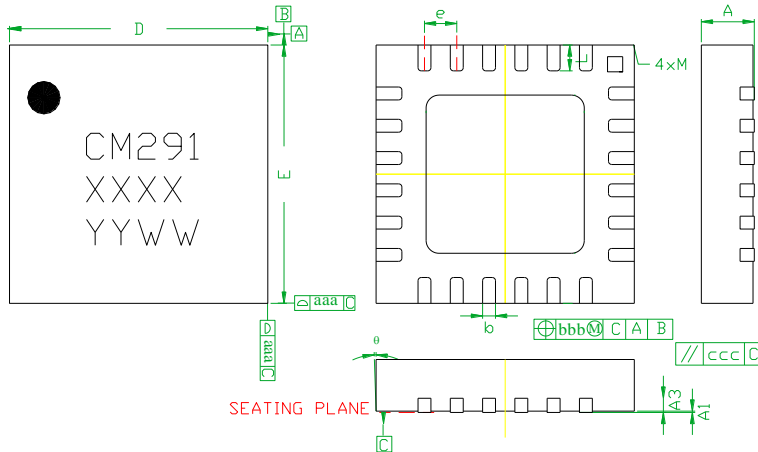

SYMBOLS	DIMENSIONS IN MILLIMETERS		
	MIN	NOM	MAX
A	0.80	0.90	1.00
A1	0	0.02	0.05
A3	---	0.25REF.	---
b	0.18	0.23	0.30
D	3.85	4.00	4.15
D1	---	2.45BSC	---
E	3.85	4.00	4.15
E1	---	2.45BSC	---
e	---	0.50BSC	---
L	0.30	0.40	0.50
theta	0	---	12
aaa	---	0.25	---
bbb	---	0.10	---
ccc	---	0.10	---
M	---	---	0.05

Notes:

1. Dimensions are in millimeters
2. RoHS compliant mold compound
3. Lead frame material: Copper alloy
4. Lead finish: 100% Matte Sn
5. Indicated dimension/tolerance applies to leads and exposed pads

Recommended PCB Land Pattern

Qorvo recommends that the user develop the land pattern that will provide the best design for proper solder reflow and device attach for their specific application. Please review Qorvo Application Note AN 105 for a recommended land pattern approach.

Recommended Solder Reflow Profile

Qorvo recommends screen printing with belt furnace reflow to ensure proper solder reflow and device attach. Please review Qorvo Application Note AN 102 for a recommended solder reflow profile.

Pin Description

Pin Diagram

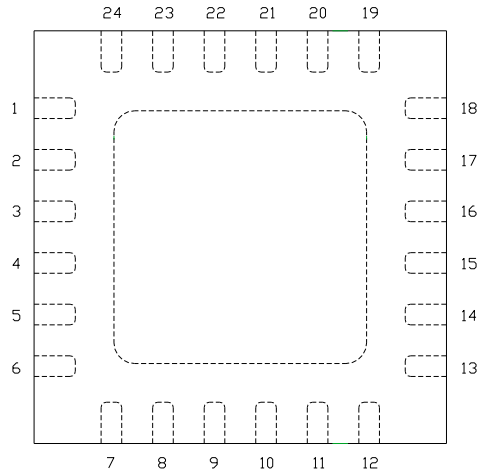

Functional Description

Pad	Function	Description	Schematic
1, 5 - 8, 10 - 14, 18, 20, 22, 24	N/C	No connection required These pins may be connected to RF/DC ground	
3	RF in	DC blocked and 50 ohm matched	
9	V _{gg}	Power supply voltage Decoupling and bypass caps required	
16	RF out	DC blocked and 50 ohm matched	
23, 21, 19	V _{dd1, 2, 3}	Power supply voltage Decoupling and bypass caps required	
2, 4, 15, 17 and die paddle	Ground	Connect to RF / DC ground	

Applications Information

Application Circuit

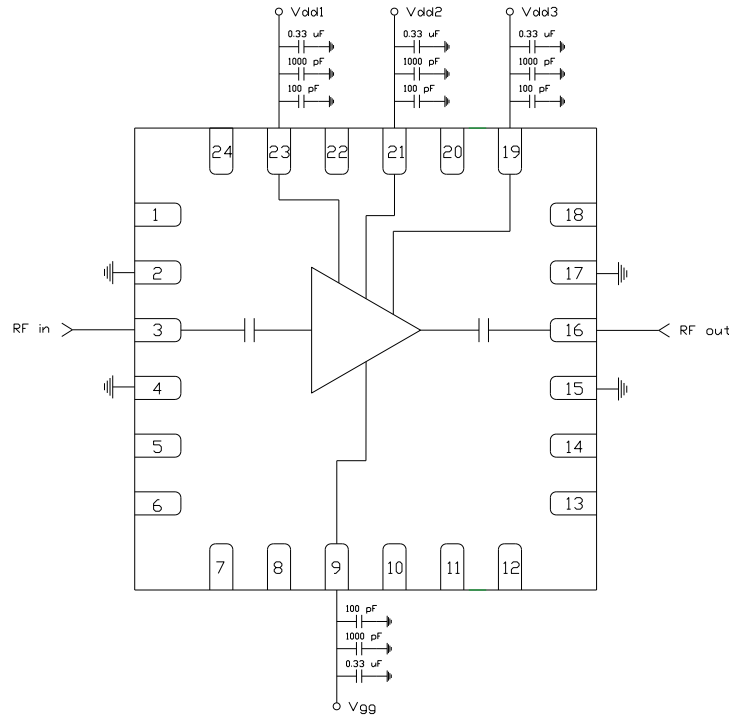

Biasing and Operation

The CMD291P4 is biased with a positive drain supply and a negative gate supply. Performance is optimized when the drain voltage is set to +5 V, though it may be set to as low as +3 V. The nominal gate voltage is -0.5 V.

Turn ON procedure:

1. Apply gate voltage V_{gg} and set to -2 V
2. Apply drain voltage V_{dd} and set to +5 V
3. Increase V_{gg} (less negative) to achieve a drain current of 250 mA

Turn OFF procedure:

1. Turn off drain voltage V_{dd}
2. Turn off gate voltage V_{gg}

RF power can be applied at any time.

GaAs MMIC devices are susceptible to damage from Electrostatic Discharge. Proper precautions should be observed during handling, assembly and test.

Applications Information

Evaluation Board

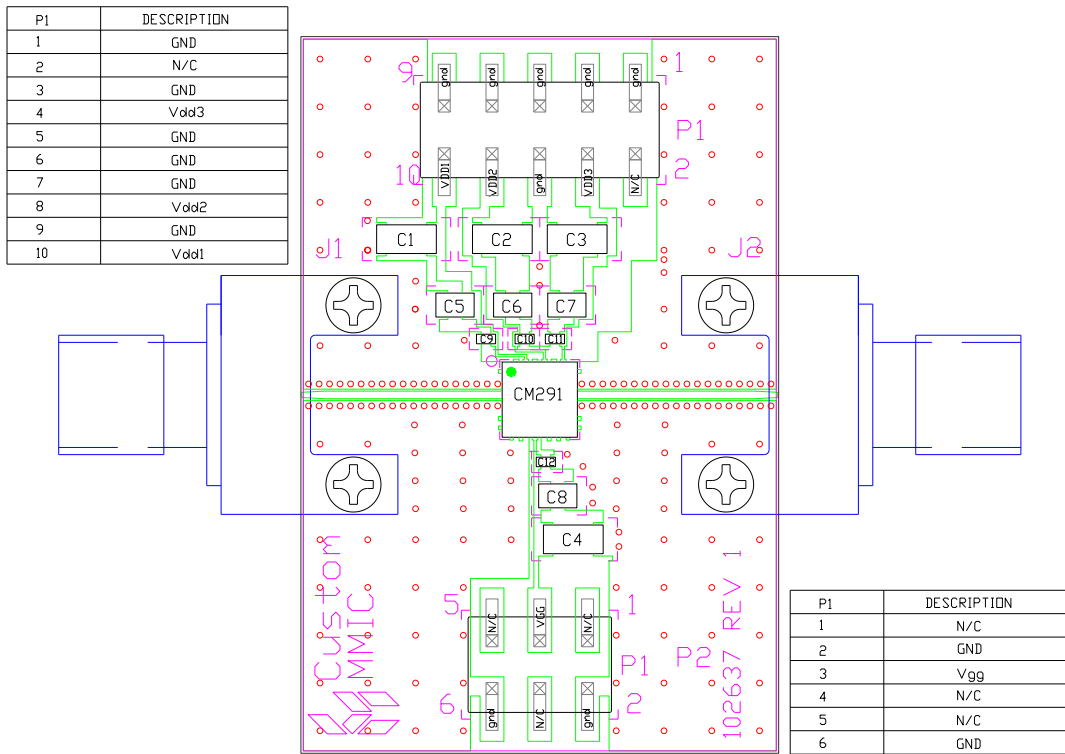

Bill of Material

Designator	Value	Description
J1, J2		2.92 mm End Launch Connector
P1		10 Pin DC Header
P2		6 Pin DC Header
C1 - C4	0.33 μ F	Capacitor, Tantalum
C5 - C8	1000 pF	Capacitor, 0603
C9 - C12	100 pF	Capacitor, 0402
U1		CMD291P4 Driver Amplifier
PCB		102637 Evaluation PCB