

Product Overview

The CMD297P34 is an analog phase shifter housed in a leadless 3x4 mm plastic surface mount package which operates from 5 to 18 GHz. The phase shifter utilizes a single positive control voltage of 0V to +10V to control relative phase shift over a 530 degree range at 7 GHz and a 220 degree range at 12 GHz. The CMD297P34 has consistent insertion loss versus phase shift and the phase shift is monotonic with respect to control voltage. The phase shifter is a 50 ohm matched design which eliminates the need for external DC blocks and RF port matching.

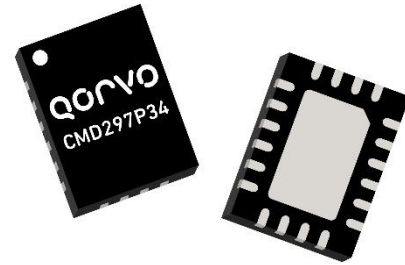

Functional Block Diagram

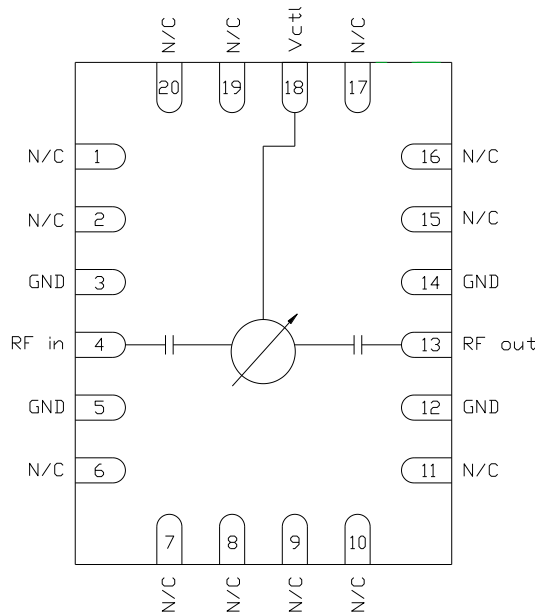

Key Features

- Wide Bandwidth
- Wide Phase Shift Range
- Single Positive Control Voltage
- Pb-Free RoHs Compliant 3x4 QFN Package

Ordering Information

Part No.	Description
CMD297P34	5-18 GHz Analog Phase Shifter, 100 Piece 7" Reel
CMD297P34-EVB	Evaluation Board

Electrical Performance ($V_{ctl} = 0\text{ V to }+10\text{ V}$, $T_A = 25\text{ }^\circ\text{C}$, $F = 12\text{ GHz}$)

Parameter	Min	Typ	Max	Units
Frequency Range		5 - 18		GHz
Phase Shift Range		220		degrees
Insertion Loss		3.2		dB
Input Return Loss		14		dB
Output Return Loss		13		dB
Phase Voltage Sensitivity		22		deg/Volt

Absolute Maximum Ratings

Parameter	Rating
Control Voltage, V_{ctl}	+ 11 V
Reverse Current	5 mA
RF Input Power	+30 dBm
Channel Temperature, T_{ch}	150 °C
Power Dissipation, P_{diss}	2 W
Thermal Resistance, θ_{JC}	32.2 °C/W
Operating Temperature	-40 to 85 °C
Storage Temperature	-55 to 150 °C

Exceeding any one or combination of the maximum ratings may cause permanent damage to the device.

Recommended Operating Conditions

Parameter	Min	Typ	Max	Units
V_{ctl}	0		10	V

Electrical performance is measured at specific test conditions. Electrical specifications are not guaranteed over all recommended operating conditions.

Electrical Specifications ($V_{ctl} = 0\text{ V to }+10\text{ V}$, $T_A = 25\text{ °C}$)

Parameter	Min	Typ	Max	Min	Typ	Max	Min	Typ	Max	Units
Frequency Range	5 - 10			10 - 13			13 - 18			GHz
Phase Shift Range	230	480		140	240		45	130		degrees
Insertion Loss		7.3	17		3.7	7		2.7	9	dB
Input Return Loss		10			13			7		dB
Output Return Loss		10			13			7		dB
Control Voltage Range	0		10	0		10	0		10	Volts
Phase Voltage Sensitivity		47			24			13		deg/Volt
Phase Temperature Sensitivity		0.15			0.1			0.05		deg/°C

Typical Performance

Insertion Loss vs. Control Voltage @ 12 GHz

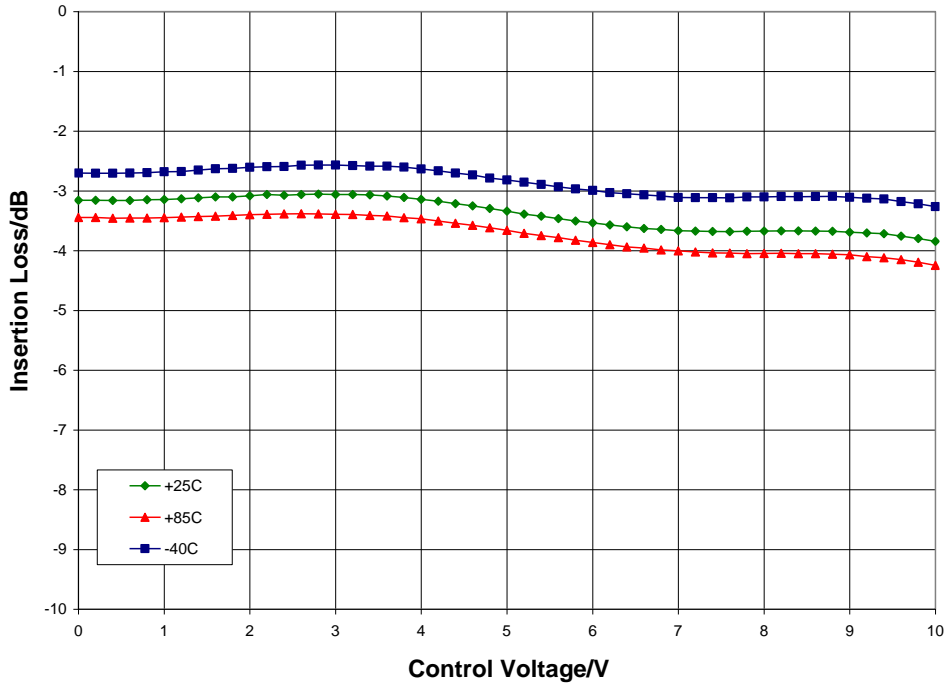

Phase Shift vs. Control Voltage, T_A = 25 °C

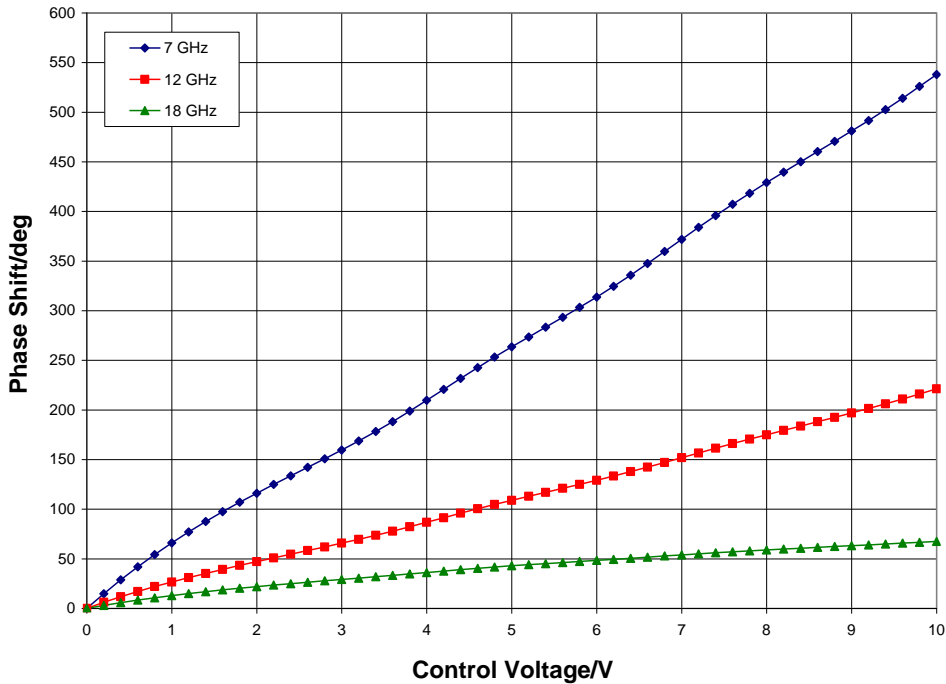

Typical Performance

Phase Shift vs. Frequency @ $V_{ctl} = 10\text{ V}$ (Relative to $V_{ctl} = 0\text{ V}$)

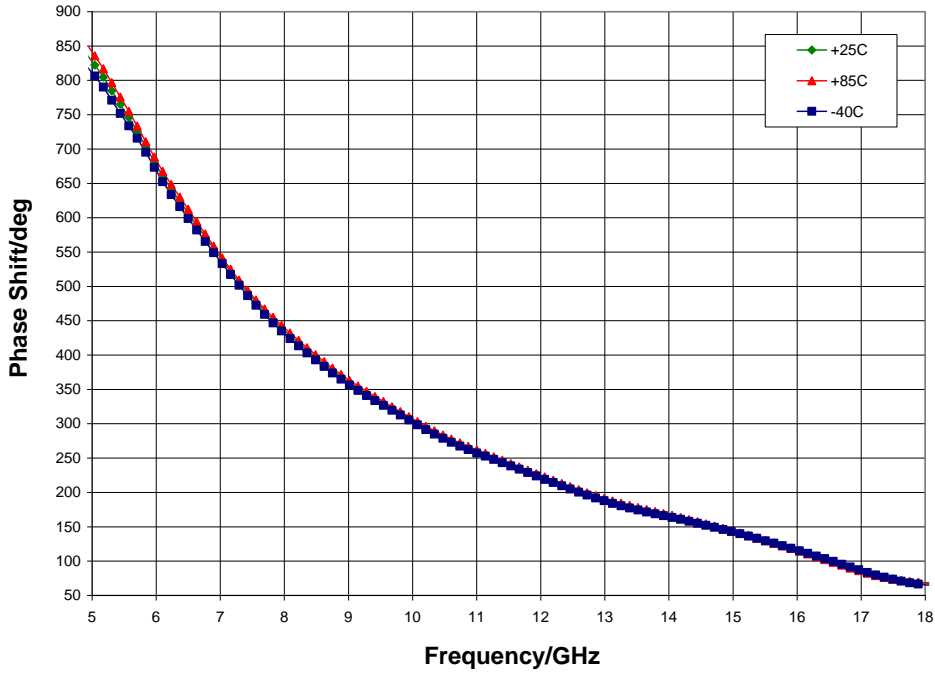

Insertion Loss vs. Frequency, $T_A = 25\text{ °C}$

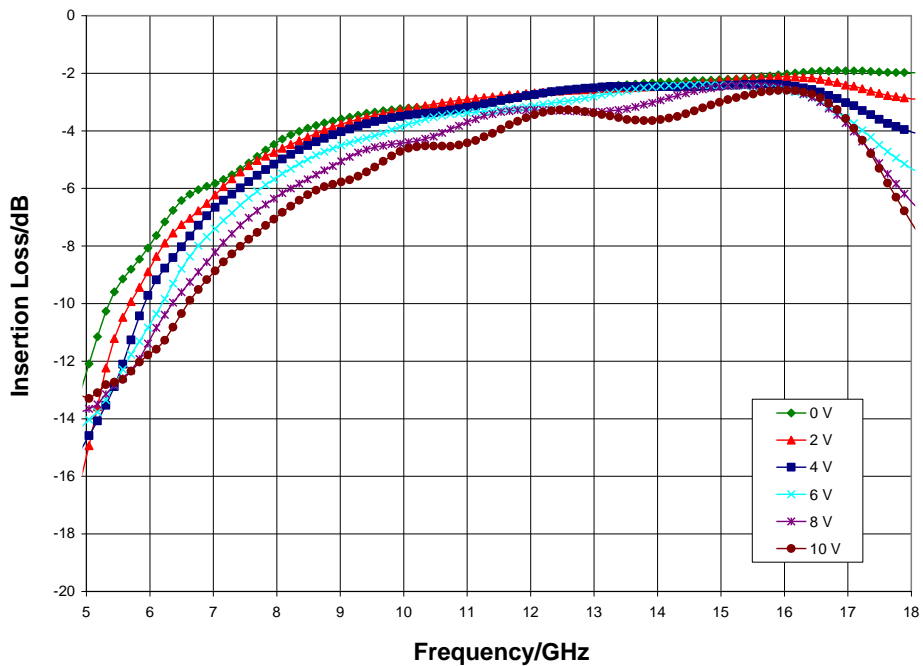

Typical Performance

Input Return Loss, $T_A = 25\text{ }^\circ\text{C}$

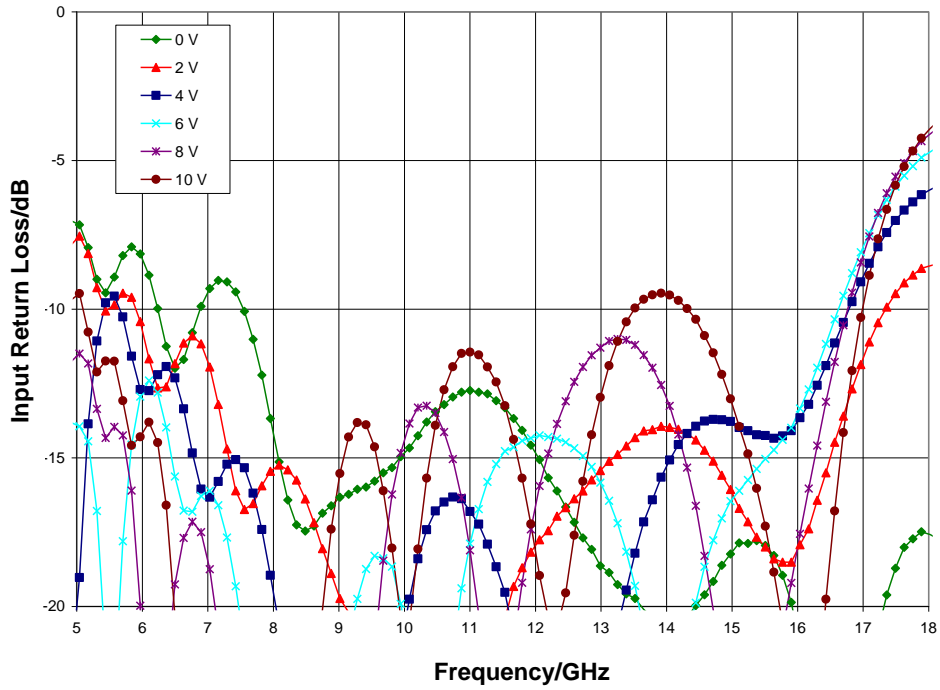

Output Return Loss, $T_A = 25\text{ }^\circ\text{C}$

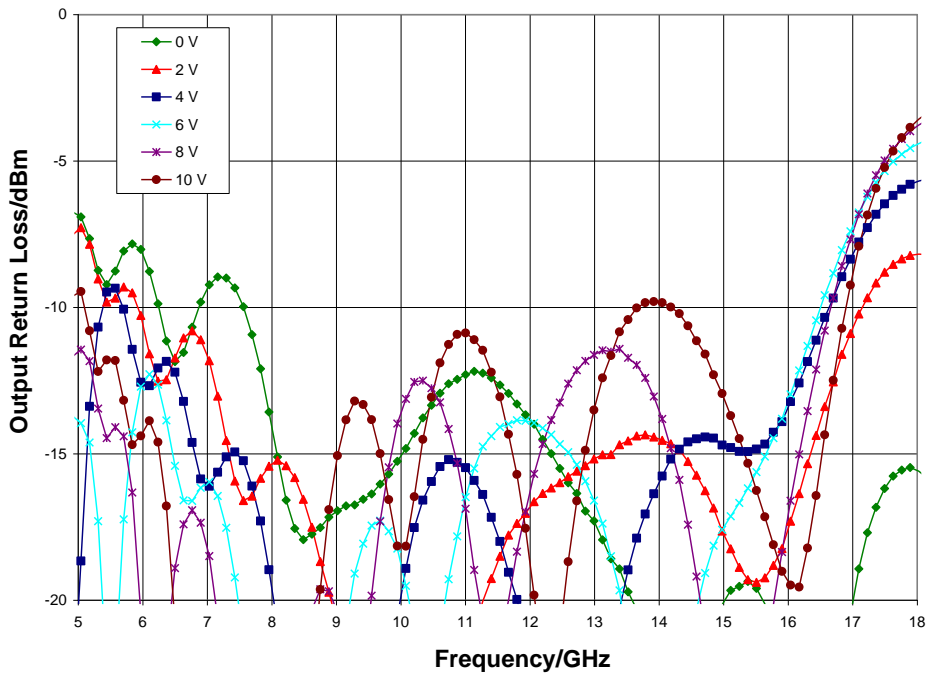

Typical Performance

Insertion Loss vs. Pin, $V_{ctl} = 0\text{ V}$, $T_A = 25\text{ °C}$

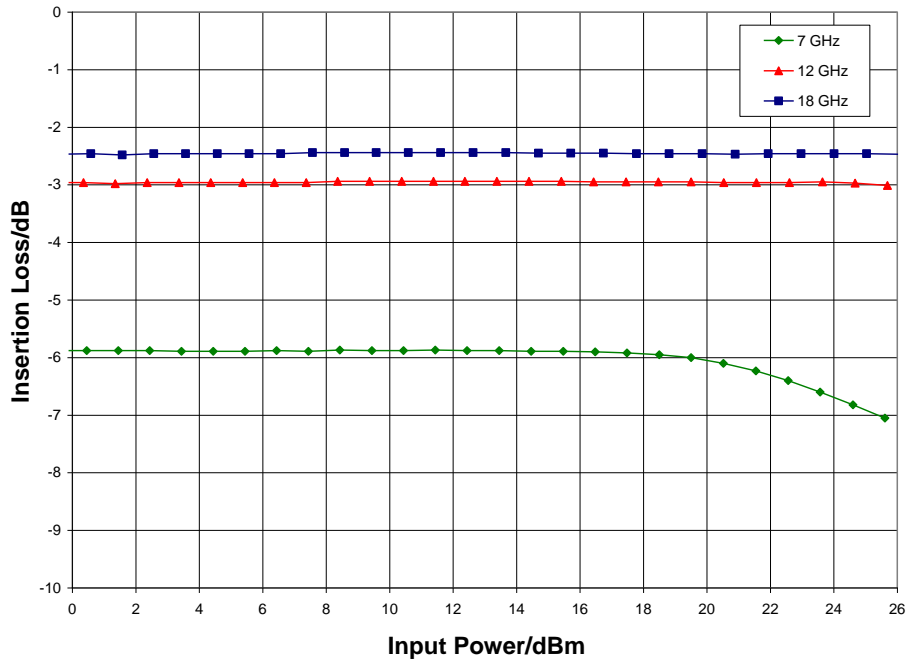

Input IP3 vs. Control Voltage, $T_A = 25\text{ °C}$

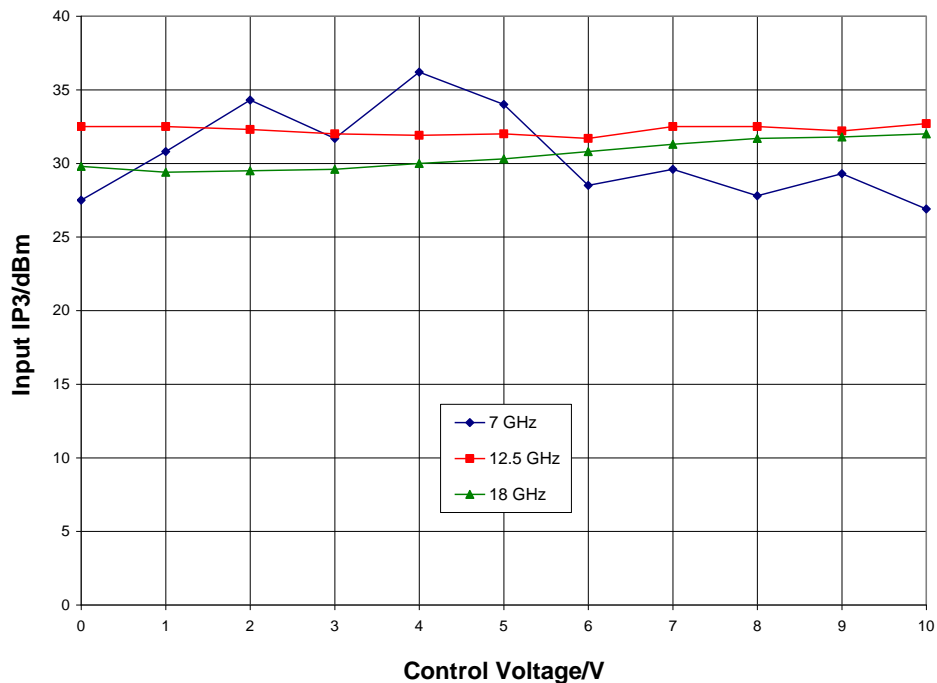

Mechanical Information

Package Information and Dimensions

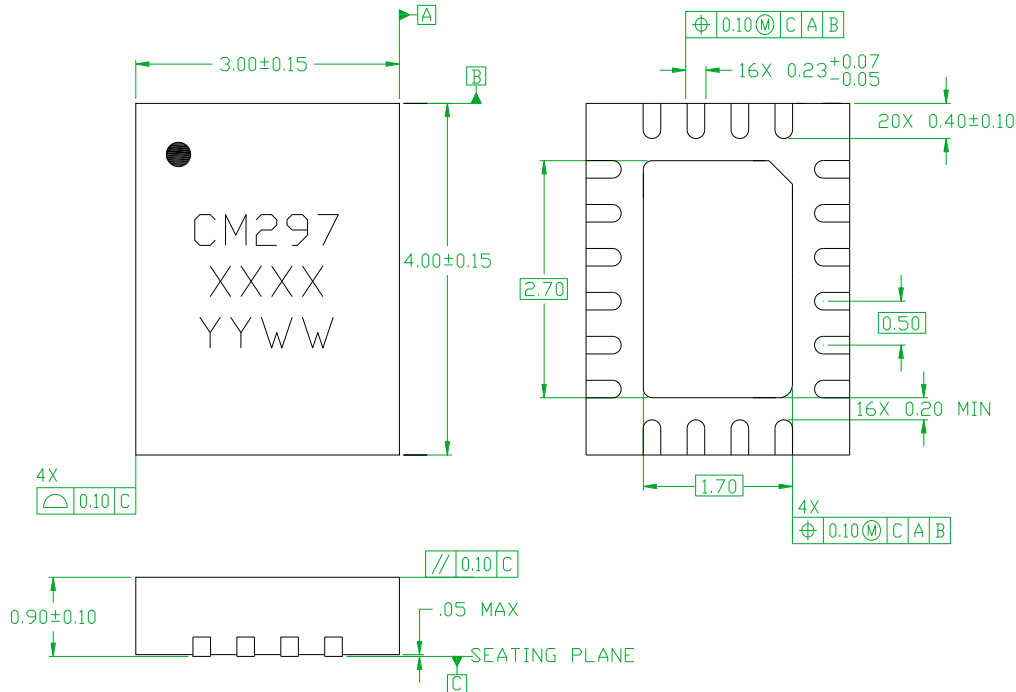

Notes:

1. Dimensions are in millimeters
2. RoHs compliant mold compound
3. Lead frame material: Copper alloy
4. Lead finish: 100% matte Sn
5. Indicated dimension/tolerance applies to leads and exposed pad

Recommended PCB Land Pattern

Qorvo recommends that the user develop the land pattern that will provide the best design for proper solder reflow and device attach for their specific application. Please review Qorvo Application Note AN 105 for a recommended land pattern approach.

Recommended Solder Reflow Profile

Qorvo recommends screen printing with belt furnace reflow to ensure proper solder reflow and device attach. Please review Qorvo Application Note AN 102 for a recommended solder reflow profile.

Pin Description

Pin Diagram

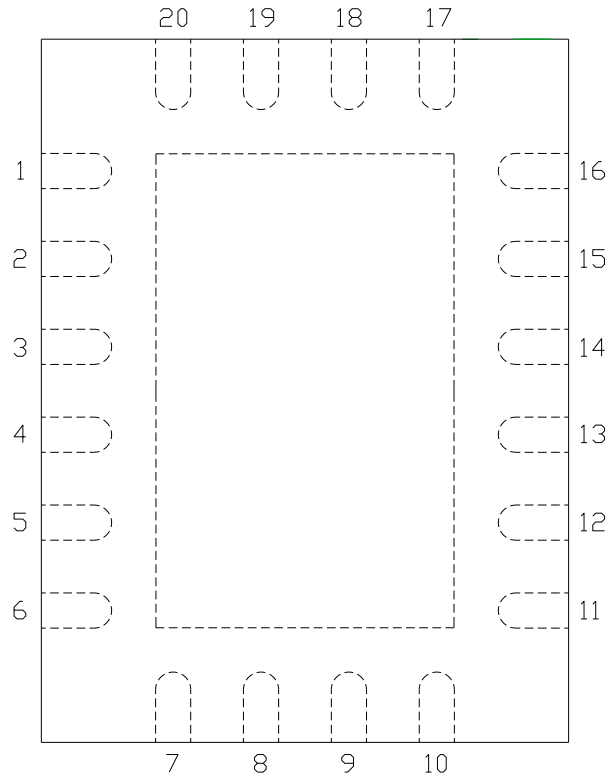

Functional Description

Pin	Function	Description	Schematic
1, 2, 6 - 11, 15 - 17, 19, 20	N/C	No connection required These pins may be connected to RF / DC ground	
4	RF in	DC blocked and 50 ohm matched	
13	RF out	DC blocked and 50 ohm matched	
18	V _{ctl}	Control voltage	
3, 5, 12, 14 and die paddle	Ground	Connect to RF / DC ground	

Applications Information

Application Circuit

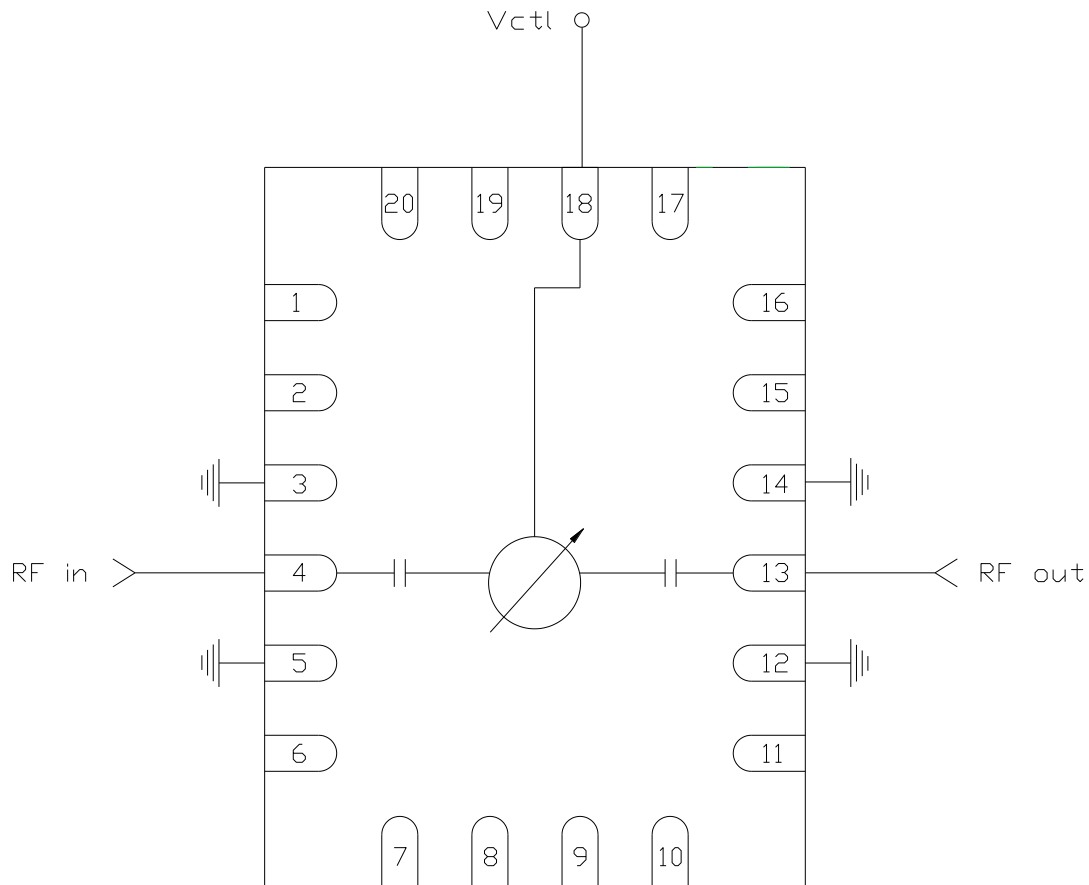

Biasing and Operation

The CMD297P34 has a single control voltage (V_{ctrl}). Full phase shift range is achieved when V_{ctrl} is varied from 0 to +10 V.

RF power can be applied at any time.

GaAs MMIC devices are susceptible to damage from Electrostatic Discharge. Proper precautions should be observed during handling, assembly and test.

Applications Information

Evaluation Board

The circuit board shown has been developed for optimized assembly at Qorvo. A sufficient number of via holes should be used to connect the top and bottom ground planes. As surface mount processes vary, careful process development is recommended.

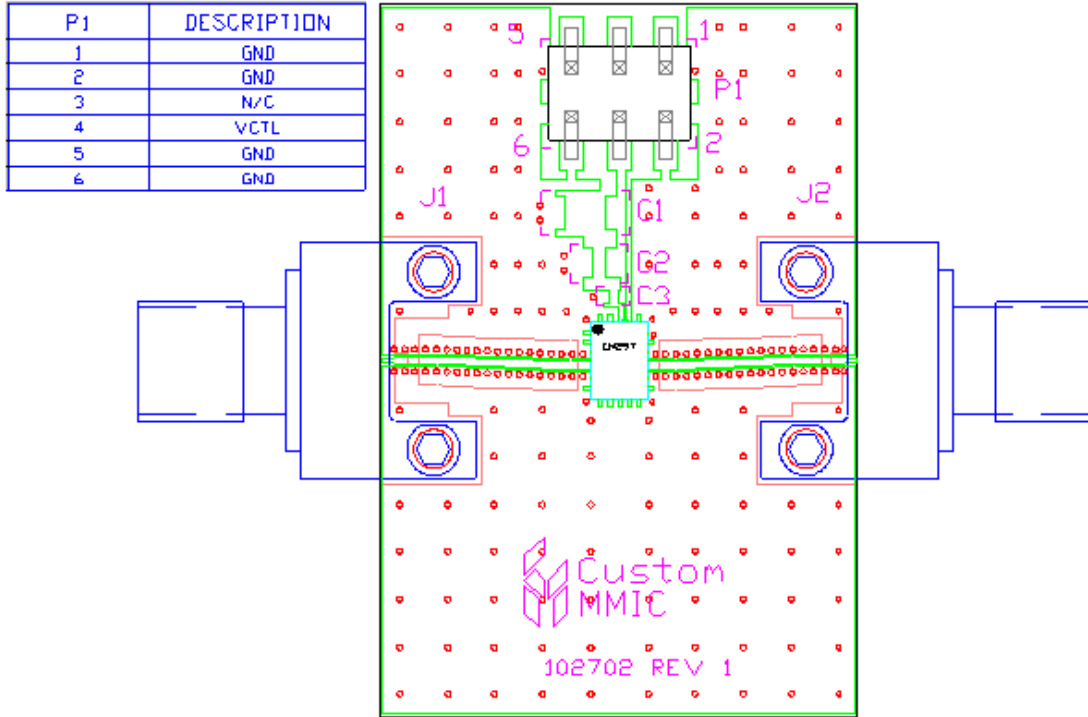

Bill of Material

Designator	Value	Description
J1, J2		SMA End Launch Connector
P1		6 Pin Header
U1		CMD297P34 Analog Phase Shifter
C1	0.33 μ F	CAP, 20%, 35V, TANT, 1206
C2	1000 pF	CAP, +/-10%, 50V, X7R, 0603
C3	100 pF	CAP, 5%, 25V, COG, 0402
PCB		102702 Evaluation PCB