

Product Overview

The CMD298C4 is a highly efficient GaAs MMIC low noise amplifier housed in a leadless 4x4 mm surface mount package. The CMD298C4 is ideally suited for EW and communications systems where small size and low power consumption are needed. The device is optimized for 21 GHz and delivers greater than 27 dB of gain with a corresponding noise figure of 1.4 dB and output 1 dB compression point of +8 dBm. The CMD298C4 is a 50 ohm matched design which eliminates the need for external DC blocks and RF port matching.

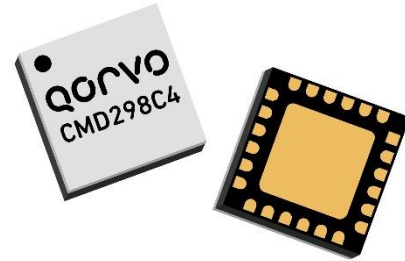

Functional Block Diagram

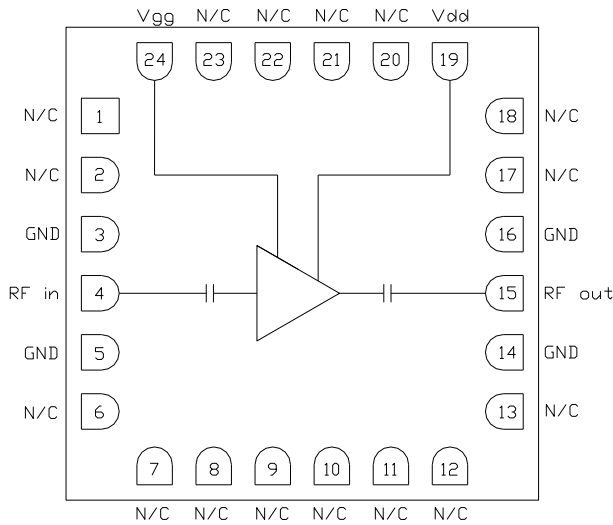

Key Features

- Ultra Low Noise Performance
- High Gain
- All Positive Supply Voltages
- Low Current Consumption
- Pb-Free RoHs Compliant 4x4 QFN Package

Ordering Information

Part No.	Description
CMD298C4	100 pcs on 7" reel
CMD298C4-EVB	Evaluation Board

Electrical Performance ($V_{dd} = 3.0\text{ V}$, $V_{gg} = 1.5\text{ V}$, $T_A = 25^\circ\text{ C}$, $F = 21\text{ GHz}$)

Parameter	Min	Typ	Max	Units
Frequency Range		17 - 25		GHz
Gain		27		dB
Noise Figure		1.4		dB
Input Return Loss		10		dB
Output Return Loss		20		dB
Output P1dB		8		dBm
Output IP3		19		dBm
Supply Current		27		mA

Absolute Maximum Ratings

Parameter	Rating
Drain Voltage, V_{dd}	4 V
Gate Voltage, V_{gg}	3.25 V
RF Input Power	+20 dBm
Channel Temperature, T_{ch}	150° C
Power Dissipation, P_{diss}	499 mW
Thermal Resistance, Q_{JC}	120.26° C/W
Operating Temperature	-40 to 85° C
Storage Temperature	-55 to 150° C

Exceeding any one or combination of the maximum ratings may cause permanent damage to the device.

Recommended Operating Conditions

Parameter	Min	Typ	Max	Units
V_{dd}	1.5	3.0	3.3	V
I_{dd}		27		mA
V_{gg}	0	1.5	3.0	V

Electrical performance is measured at specific test conditions. Electrical specifications are not guaranteed over all recommended operating conditions.

Electrical Specifications ($V_{dd} = 3.0$ V, $V_{gg} = 1.5$ V, $T_A = 25^\circ$ C)

Parameter	Min	Typ	Max	Min	Typ	Max	Units
Frequency Range	17 - 22			22 - 25			GHz
Gain	24	27.5		22	26		dB
Noise Figure		1.5	2		1.4	2	dB
Input Return Loss		10			13		dB
Output Return Loss		10			12		dB
Output P1dB		8			9		dBm
Output IP3		18			20		dBm
Supply Current	19	27	35	19	27	35	mA
Gain Temperature Coefficient		0.02			0.02		dB/°C
Noise Figure Temperature Coefficient		0.007			0.007		dB/°C

Typical Performance

Broadband Performance, $V_{dd} = 3.0\text{ V}$, $V_{gg} = 1.5\text{ V}$, $I_{dd} = 27\text{ mA}$, $T_A = 25^\circ\text{ C}$

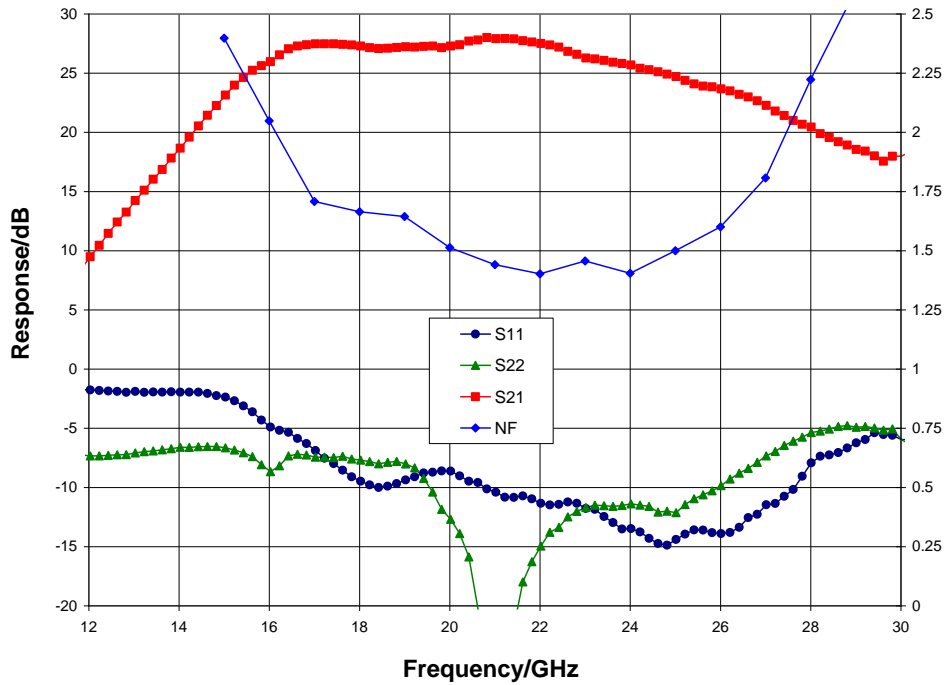

Narrow-band Performance, $V_{dd} = 3.0\text{ V}$, $V_{gg} = 1.5\text{ V}$, $I_{dd} = 27\text{ mA}$, $T_A = 25^\circ\text{ C}$

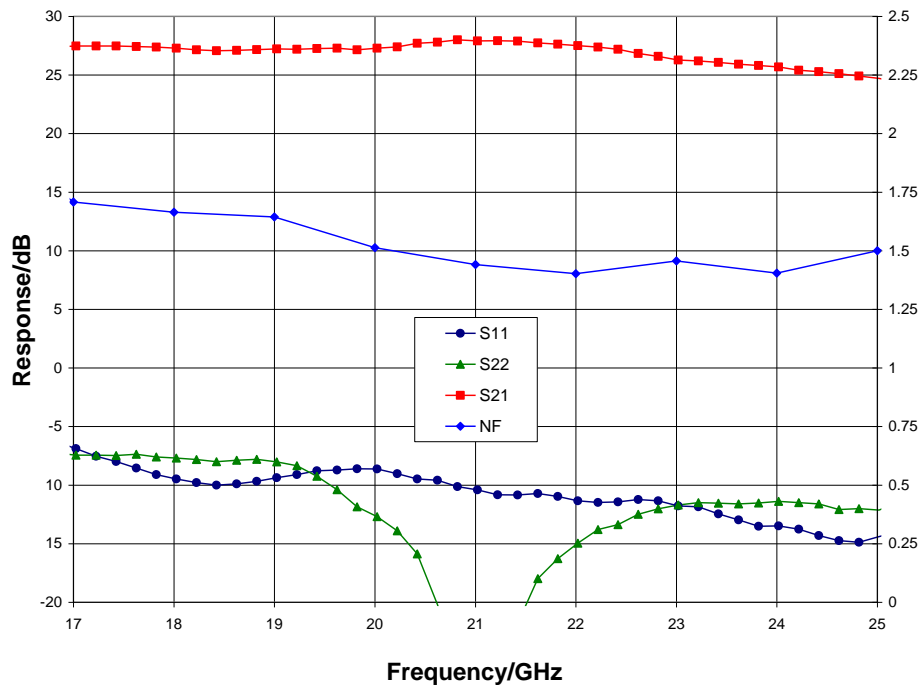

Typical Performance

Gain vs. Temperature, $V_{dd} = 3.0\text{ V}$, $V_{gg} = 1.5\text{ V}$

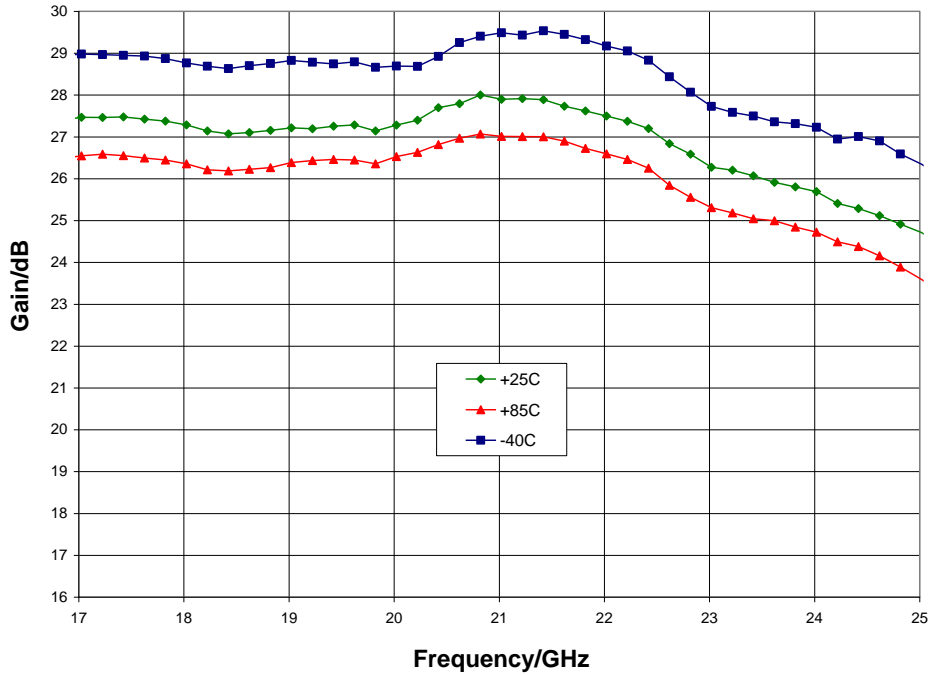

Gain vs. V_{dd} , $V_{gg} = 1.5\text{ V}$, $T_A = 25^\circ\text{ C}$

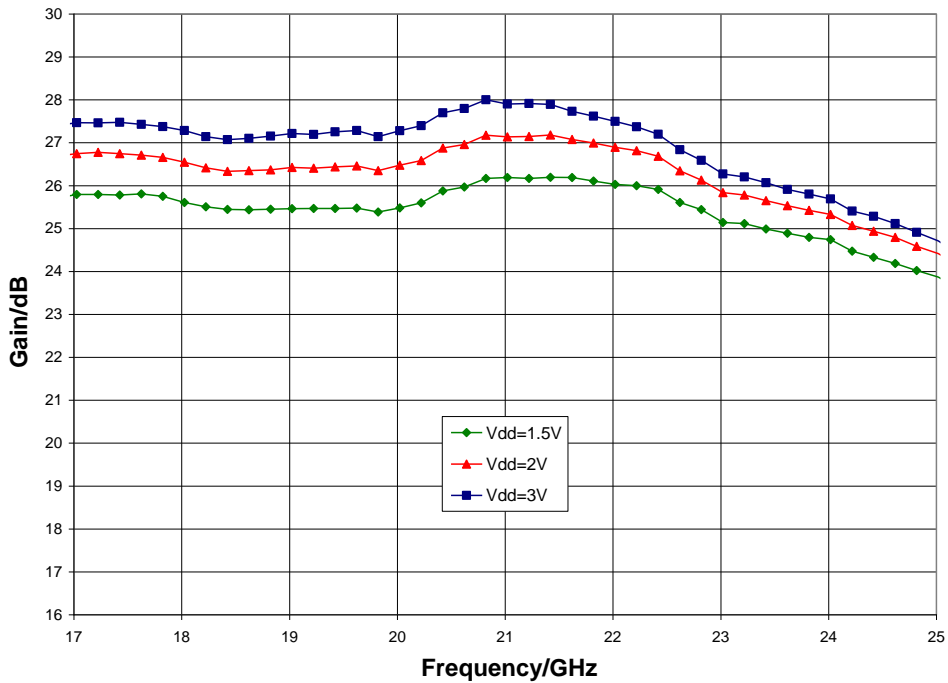

Typical Performance

Noise Figure vs. Temperature, $V_{dd} = 3.0\text{ V}$, $V_{gg} = 1.5\text{ V}$

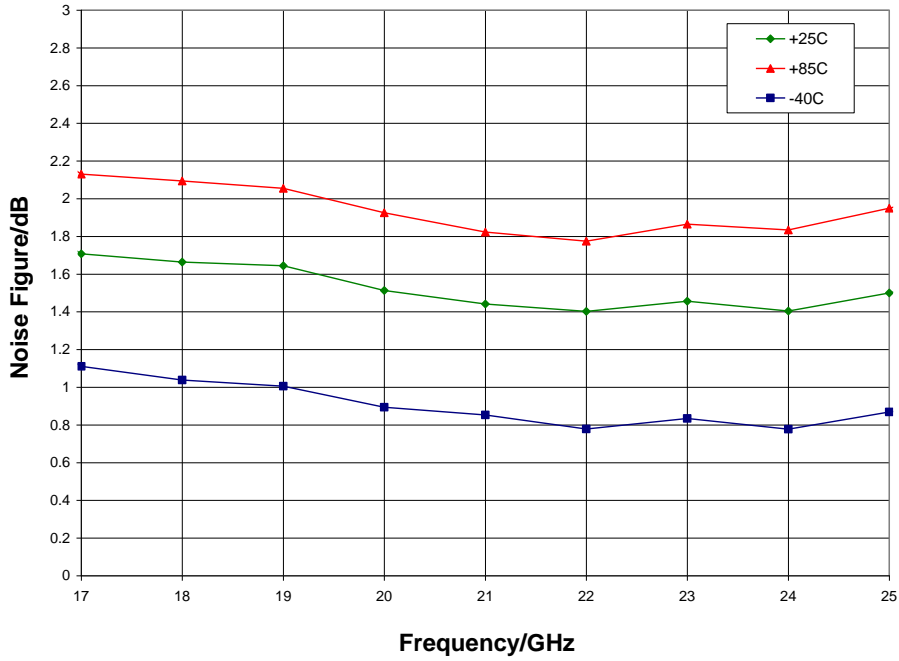

Noise Figure vs. V_{dd} , $V_{gg} = 1.5\text{ V}$, $T_A = 25^\circ\text{ C}$

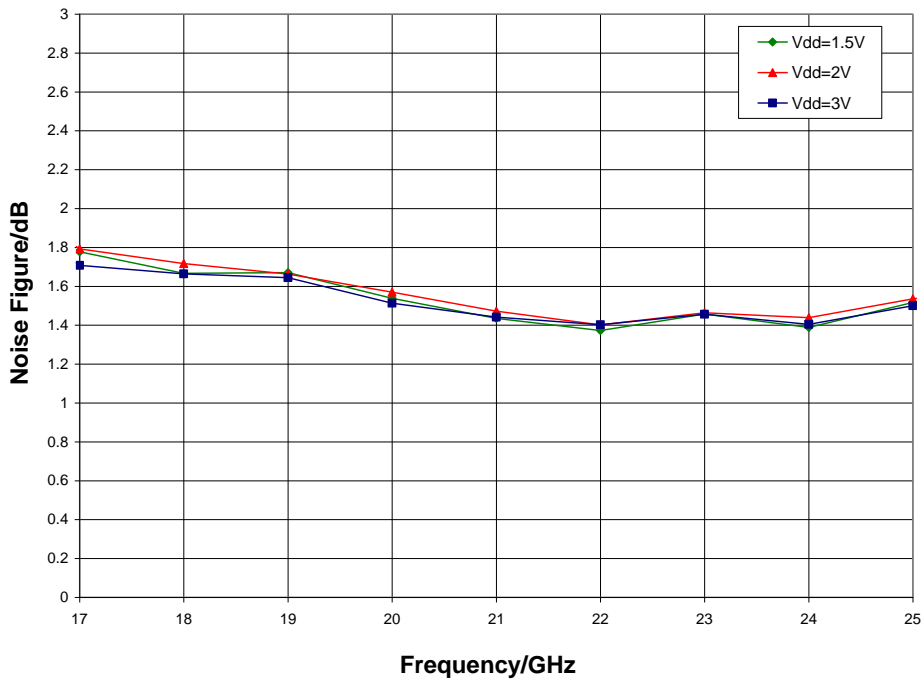

Typical Performance

P1dB vs. Temperature, $V_{dd} = 3.0\text{ V}$, $V_{gg} = 1.5\text{ V}$

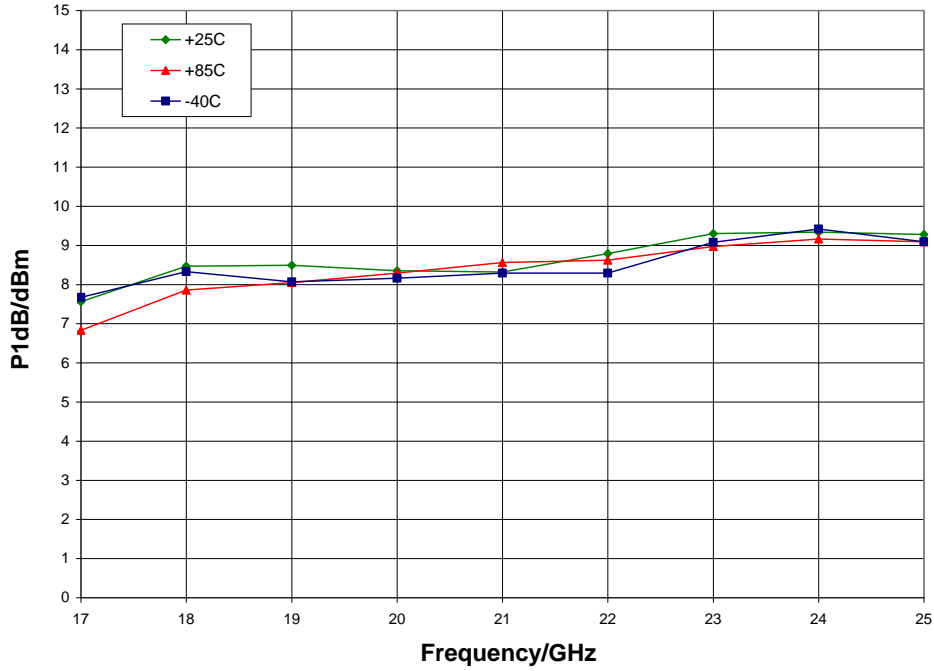

P1dB vs. V_{dd} , $V_{gg} = 1.5\text{ V}$, $T_A = 25^\circ\text{ C}$

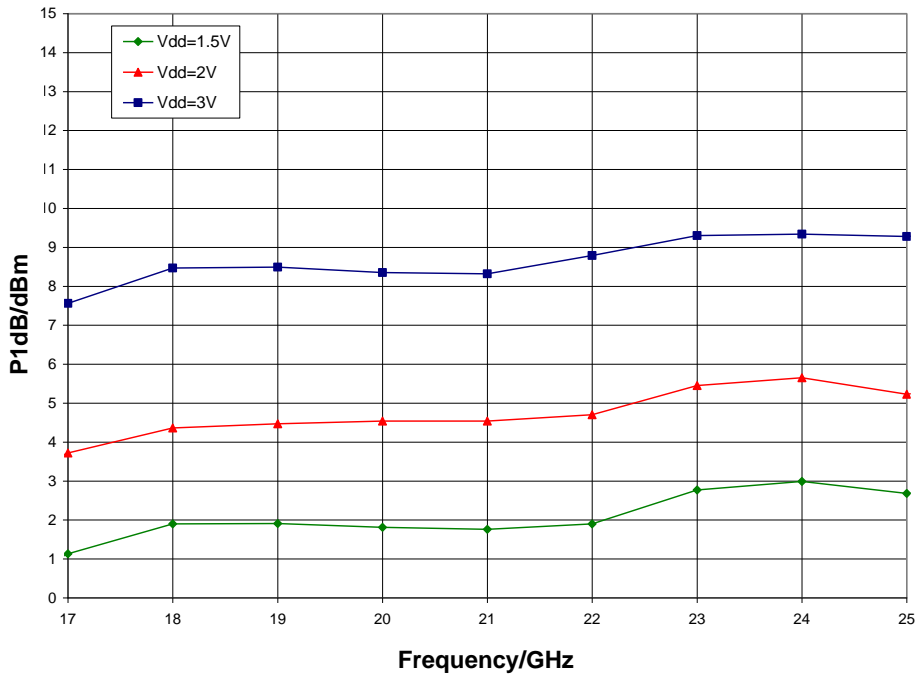

Typical Performance

Psat vs. Temperature, $V_{dd} = 3.0\text{ V}$, $V_{gg} = 1.5\text{ V}$

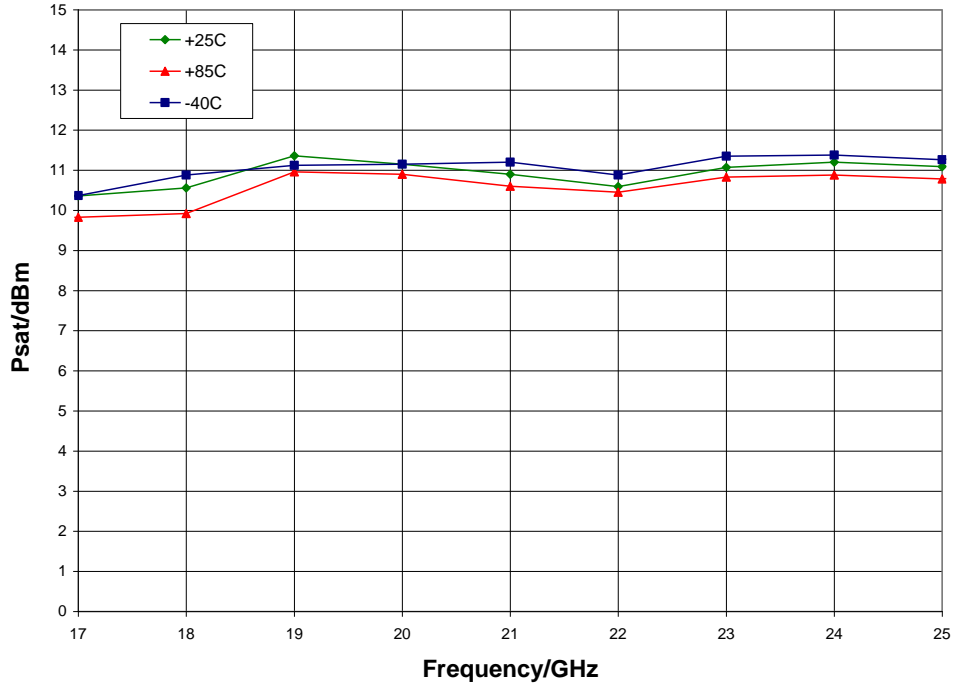

Psat vs. V_{dd} , $V_{gg} = 1.5\text{ V}$, $T_A = 25^\circ\text{ C}$

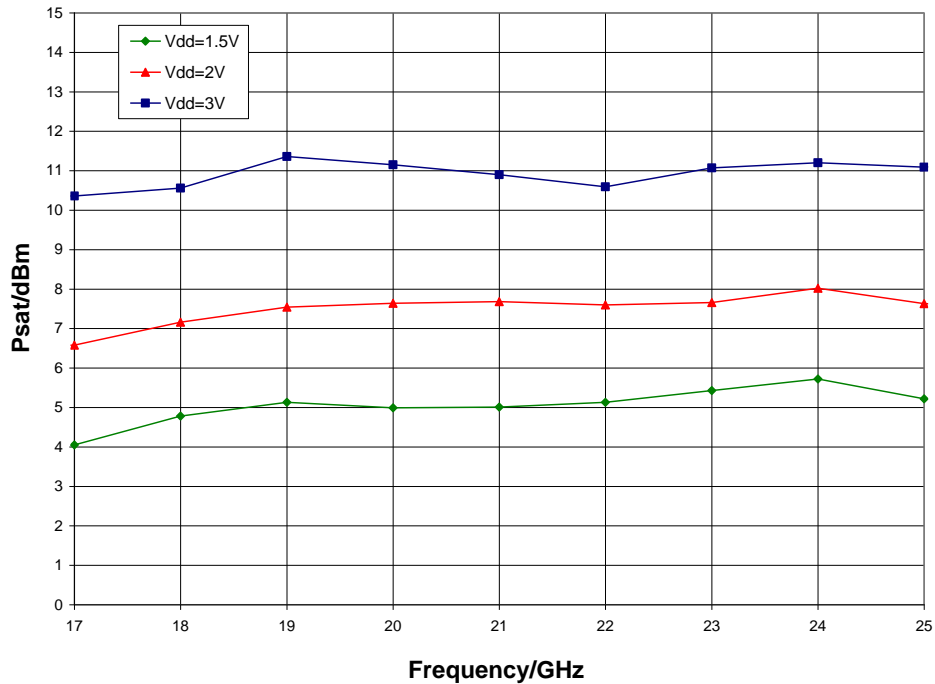

Typical Performance

Output IP3 vs. Temperature, $V_{dd} = 3.0\text{ V}$, $V_{gg} = 1.5\text{ V}$

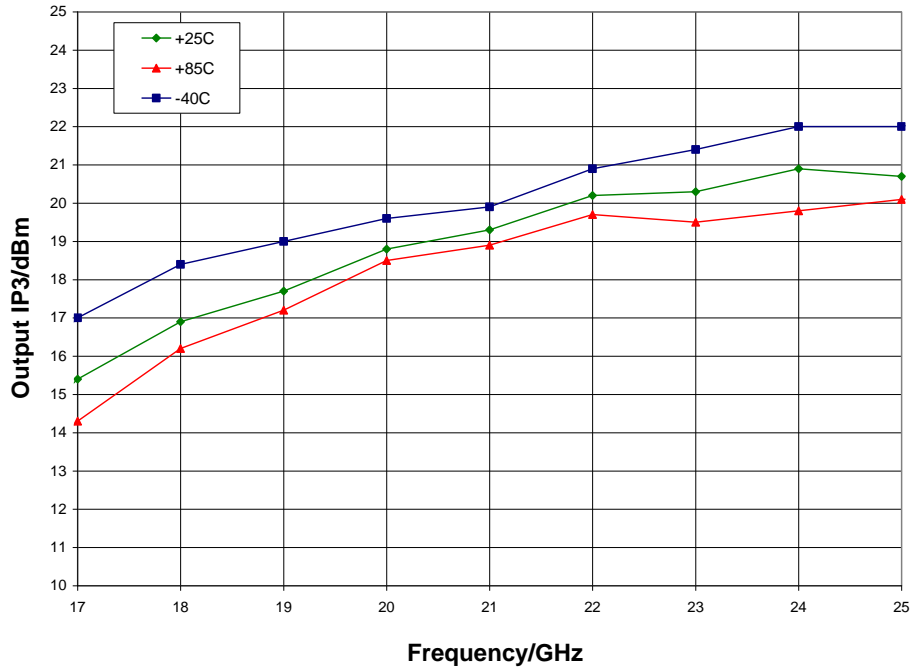

Output IP3 vs. V_{dd} , $V_{gg} = 1.5\text{ V}$, $T_A = 25^\circ\text{ C}$

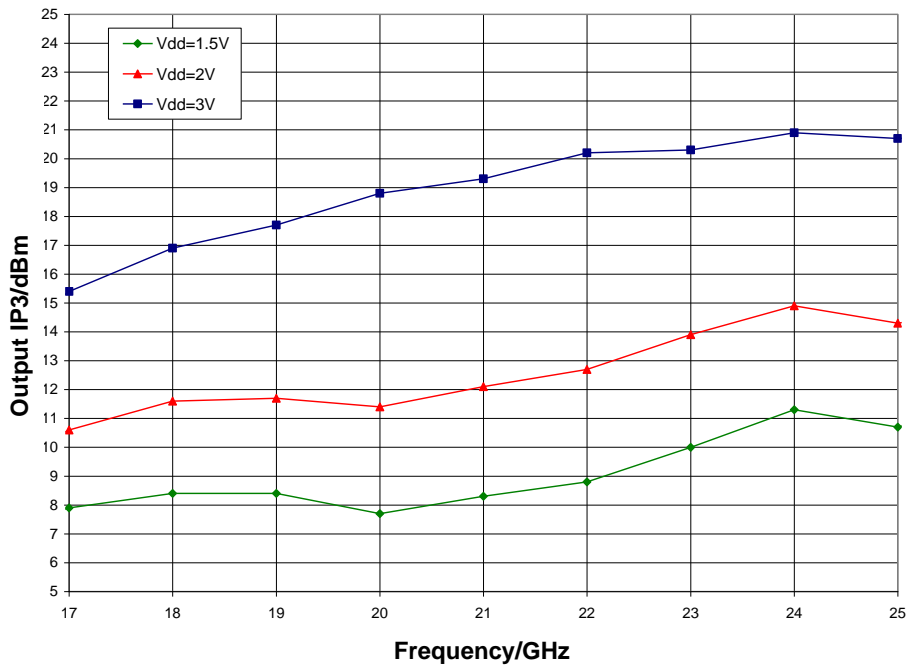

Pin Description

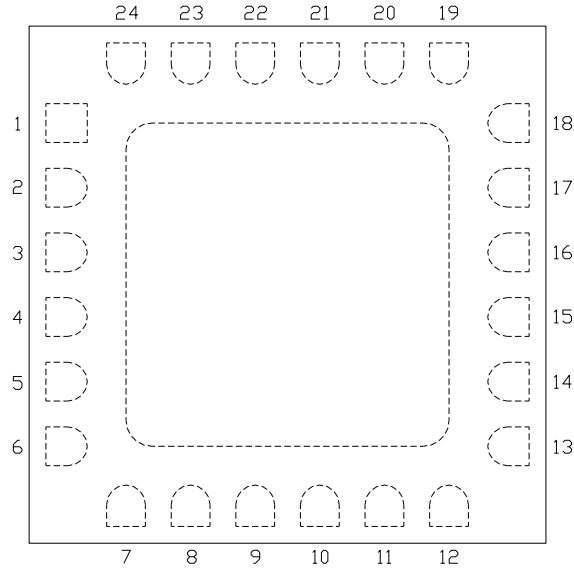

Functional Description

Pin	Function	Description	Schematic
1, 2, 6 - 13, 17, 18, 20 - 23	N/C	No connection required These pins may be connected to RF / DC ground	
3, 5, 14, 16 and die paddle	Ground	Connect to RF / DC ground	
4	RF in	DC blocked and 50 ohm matched	
15	RF out	DC blocked and 50 ohm matched	
19	V _{dd}	Power supply voltage Decoupling and bypass caps required	
24	V _{gg}	Power supply voltage Decoupling and bypass caps required	

Applications Information

Application Circuit

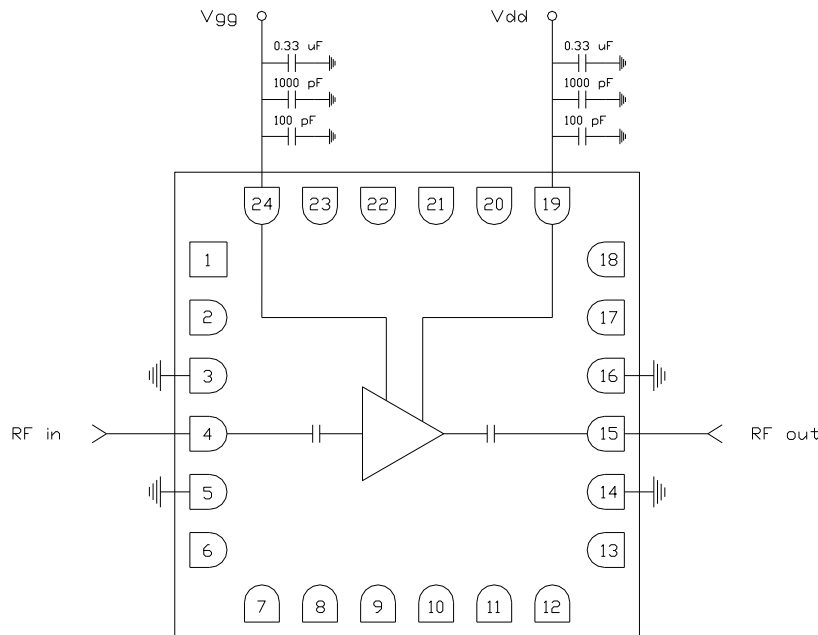

Biasing and Operation

The CMD298C4 is biased with a positive drain supply and positive gate supply. Sequencing of the drain and gate supply is not required. Performance is optimized when the drain voltage is set to +3.0 V, though it may be set to a minimum of +1.5 V and a maximum of +3.5 V. The recommended gate voltage is +1.5 V.

Turn ON procedure:

1. Apply drain voltage V_{dd} and set to +3 V
2. Apply gate voltage V_{gg} and set to +1.5 V

Turn OFF procedure:

1. Turn off gate voltage V_{gg}
2. Turn off drain voltage V_{dd}

Refer to Application Note 103: Amplifier Biasing Techniques for instructions on how to implement a single supply biasing scheme.

RF power can be applied at any time.

Applications Information

Evaluation Board

The circuit board shown has been developed for optimized assembly at Qorvo. A sufficient number of via holes should be used to connect the top and bottom ground planes. As surface mount processes vary, careful process development is recommended.

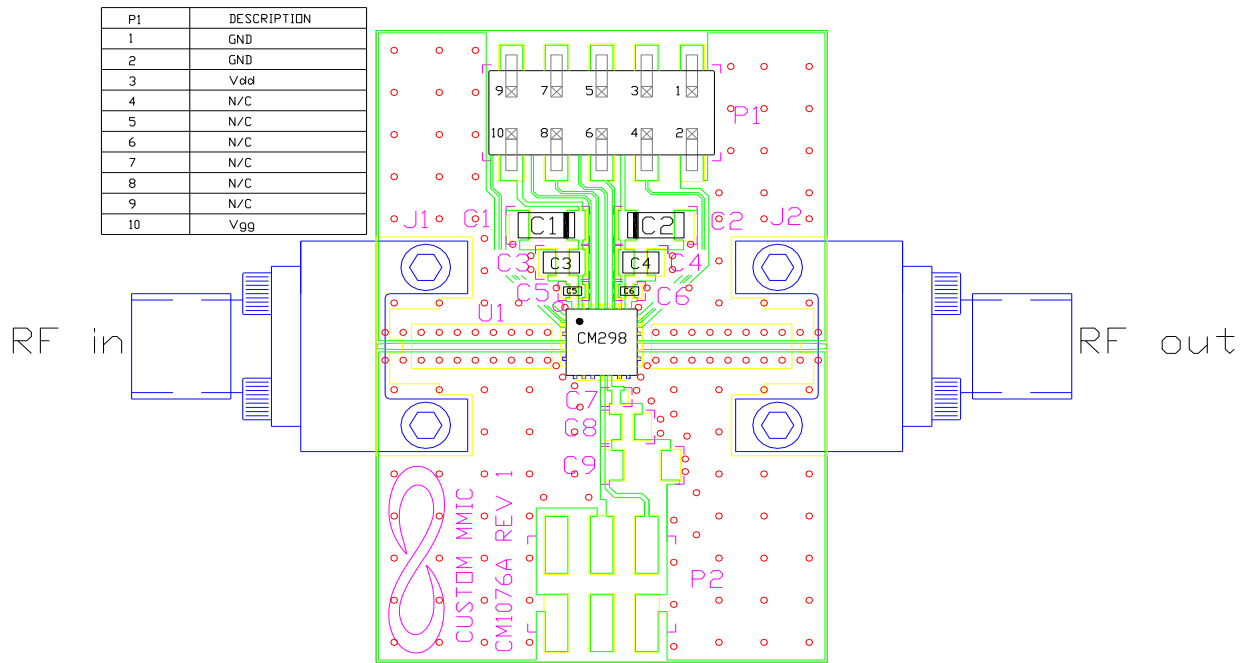

Designator	Value	Description
J1, J2		SMA End Launch Connector
P1		10 Pin Header
C1, C2	0.33 μ F	Capacitor, Tantalum
C3, C4	1000 pF	Capacitor, 0603
C5, C6	100 pF	Capacitor, 0402
U1		CMD298C4 Low Noise Amplifier
PCB		CM1076A Evaluation PCB

GaAs MMIC devices are susceptible to damage from Electrostatic Discharge. Proper precautions should be observed during handling, assembly and test.