

Product Overview

The CMD305C4 is a broadband MMIC driver amplifier housed in a leadless 4x4 mm surface mount package. The CMD305C4 is ideally suited for EW and communications systems where small size and low power consumption are needed. The broadband device delivers 18.5 dB of gain and +21 dBm saturated output power at 23% PAE from a single 5 V supply. The CMD305C4 is a 50 ohm matched design eliminating the need for external DC blocks and RF port matching.

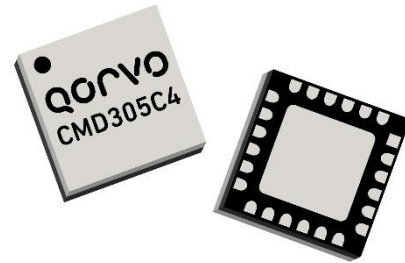

Functional Block Diagram

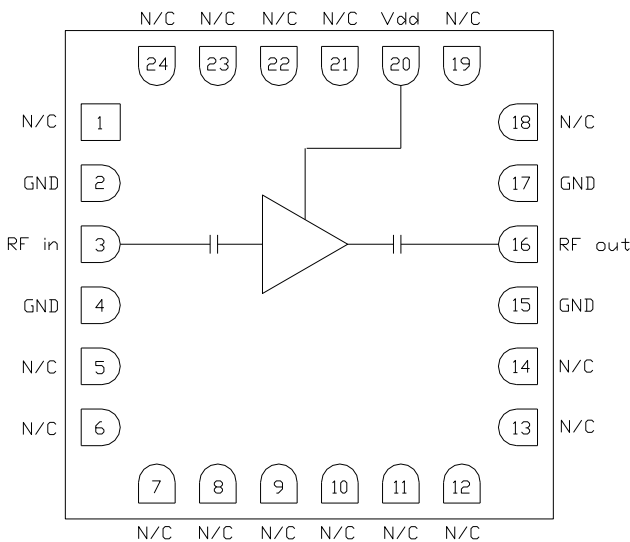

Key Features

- Broadband Performance
- High Output Power
- Low Current Consumption
- Single Positive Supply Voltage
- Pb-Free RoHs Compliant 4x4 QFN Package

Ordering Information

Part No.	Description
CMD305C4	100 pcs on 7" reel
CMD305C4-EVB	Evaluation Board

Electrical Performance ($V_{dd} = 5.0\text{ V}$, $T_A = 25^\circ\text{C}$, $F = 10\text{ GHz}$)

Parameter	Min	Typ	Max	Units
Frequency Range		6 - 16		GHz
Gain		18.5		dB
Input Return Loss		13		dB
Output Return Loss		10		dB
Output P1dB		20		dBm
Output Psat		21		dBm
Output IP3		33		dBm
Supply Current		100		mA

Absolute Maximum Ratings

Parameter	Rating
Drain Voltage, V_{dd}	5.5 V
RF Input Power	+10 dBm
Channel Temperature, T_{ch}	150° C
Power Dissipation, P_{diss}	650 mW
Thermal Resistance, Q_{JC}	100° C/W
Operating Temperature	-40 to 85° C
Storage Temperature	-55 to 150° C

Exceeding any one or combination of the maximum ratings may cause permanent damage to the device.

Recommended Operating Conditions

Parameter	Min	Typ	Max	Units
V_{dd}	3.0	5.0	5.25	V
I_{dd}		100		mA

Electrical performance is measured at specific test conditions. Electrical specifications are not guaranteed over all recommended operating conditions.

Drain Current vs. Drain Voltage

V_{dd} (V)	I_{dd} (mA)
3.0	65
4.0	85
5.0	100

Electrical Specifications ($V_{dd} = 5.0$ V, $T_A = 25^\circ$ C)

Parameter	Min	Typ	Max	Min	Typ	Max	Units
Frequency Range		6 - 9			9 - 16		GHz
Gain	16	19.5		15	18		dB
Noise Figure		6			4.5		dB
Input Return Loss		11			13		dB
Output Return Loss		11			9		dB
Output P1dB	15.5	19		16	20		dBm
Output Psat		20			21		dBm
Output IP3		32			33		dBm
Supply Current	70	100	130	70	100	130	mA
Gain Temperature Coefficient		0.016			0.016		dB/°C

Typical Performance

Broadband Performance, $V_{dd} = 5.0\text{ V}$, $T_A = 25^\circ\text{ C}$

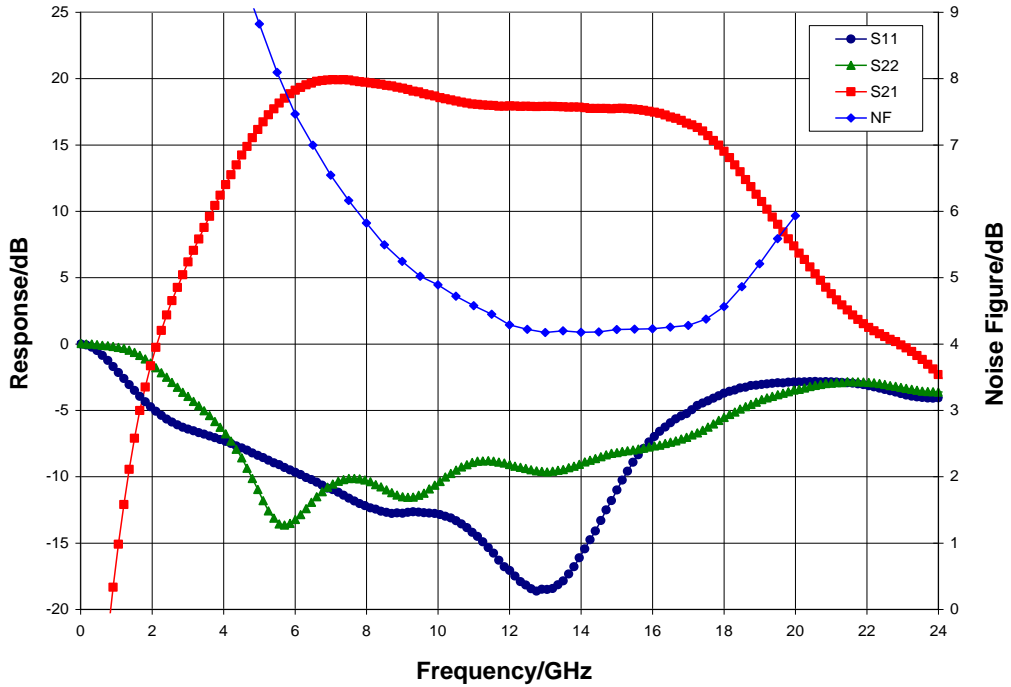

Narrow-band Performance, $V_{dd} = 5.0\text{ V}$, $T_A = 25^\circ\text{ C}$

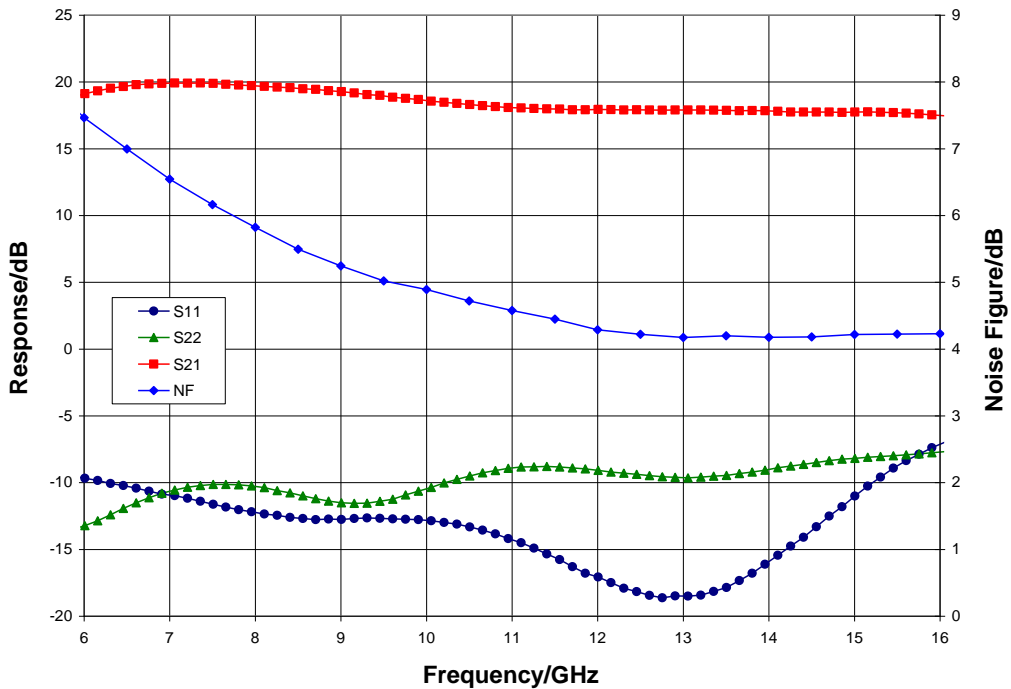

Typical Performance

Gain vs. Temperature, $V_{dd} = 5.0\text{ V}$

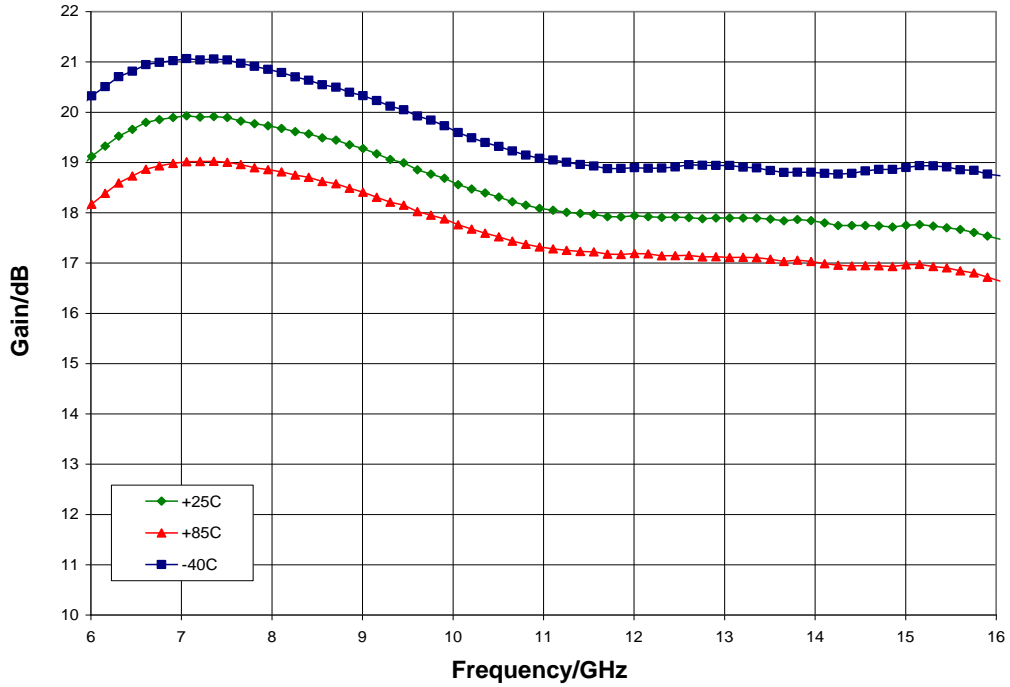

Gain vs. V_{dd} , $T_A = 25^\circ\text{ C}$

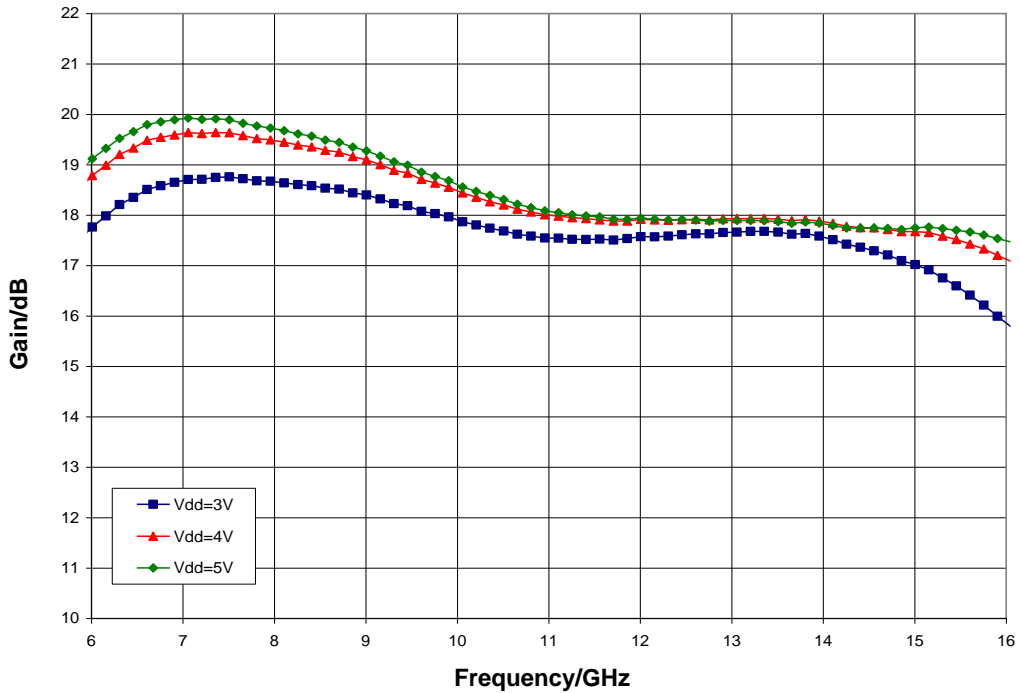

Typical Performance

Noise Figure vs. Temperature, $V_{dd} = 5.0\text{ V}$

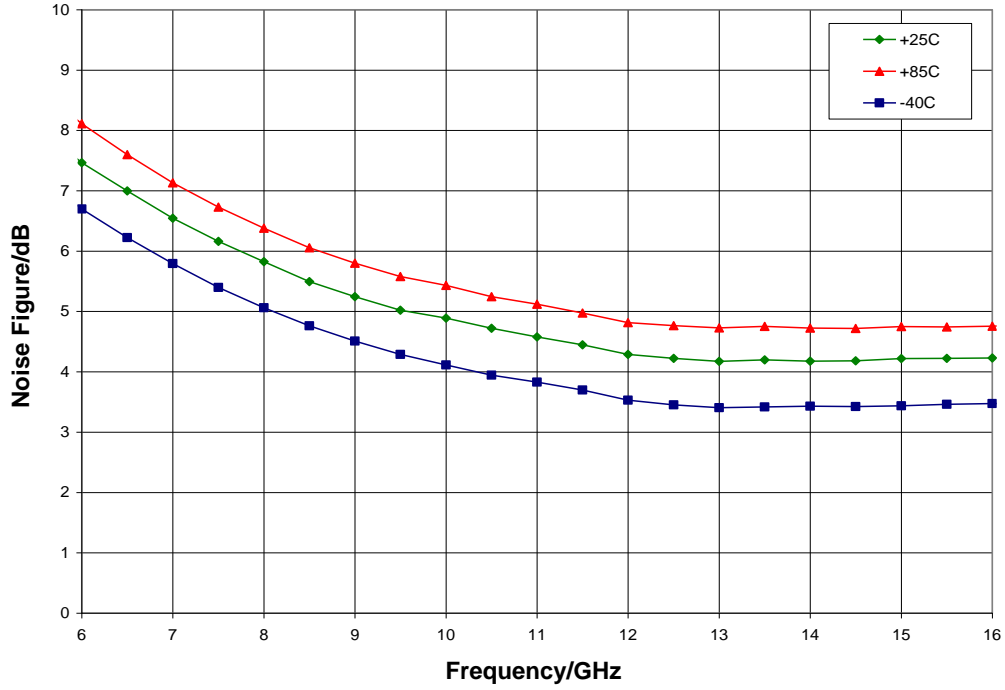

Noise Figure vs. V_{dd} , $T_A = 25^\circ\text{ C}$

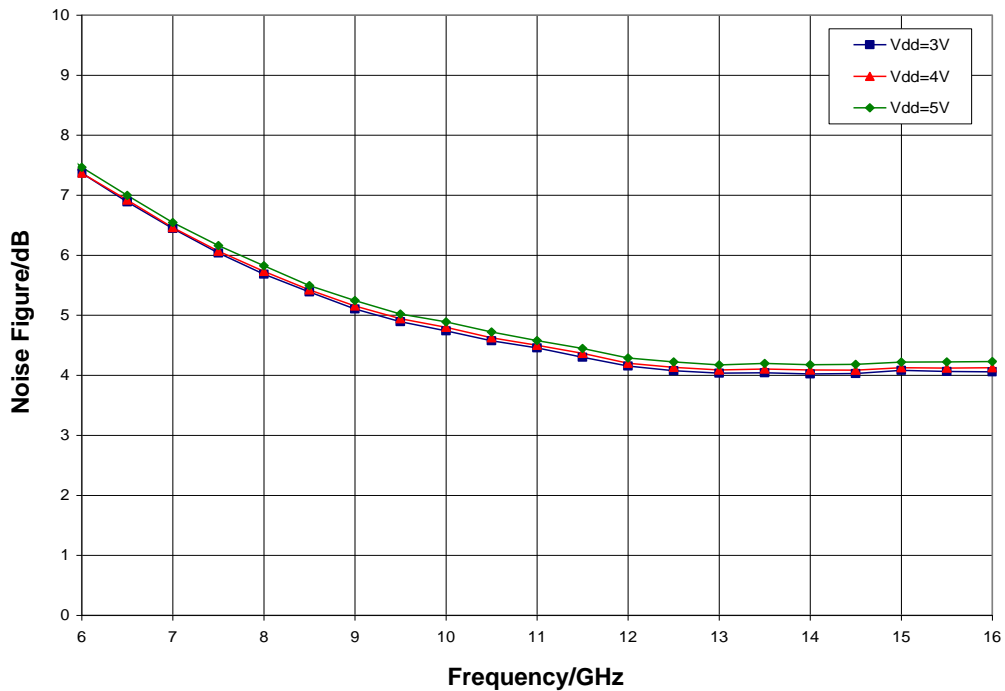

Typical Performance

P1dB vs. Temperature, $V_{dd} = 5.0\text{ V}$

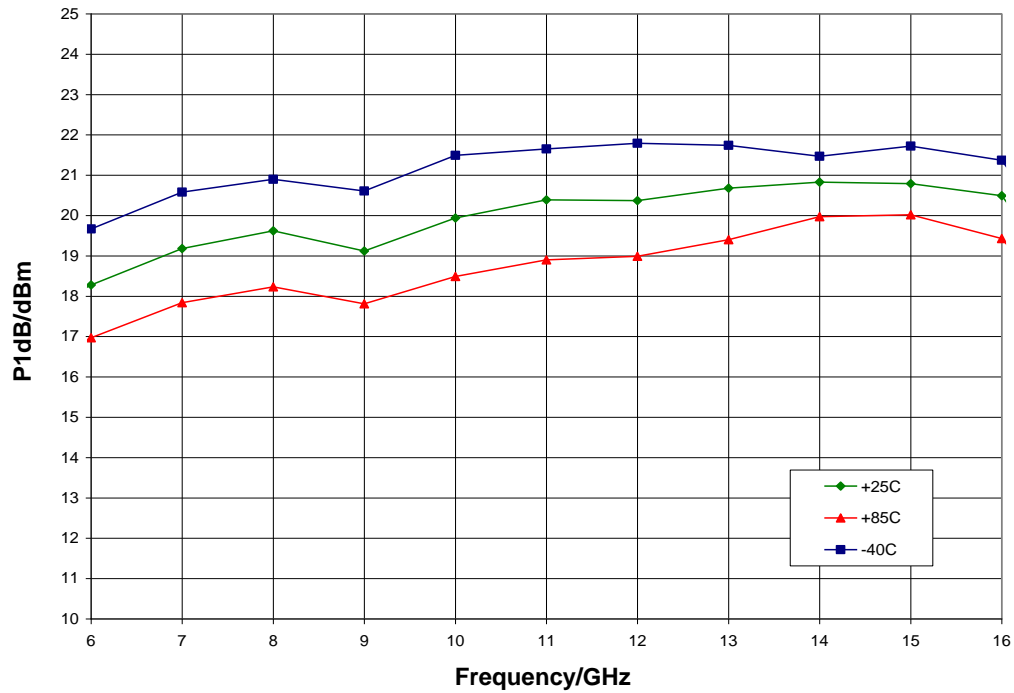

P1dB vs. V_{dd} , $T_A = 25^\circ\text{ C}$

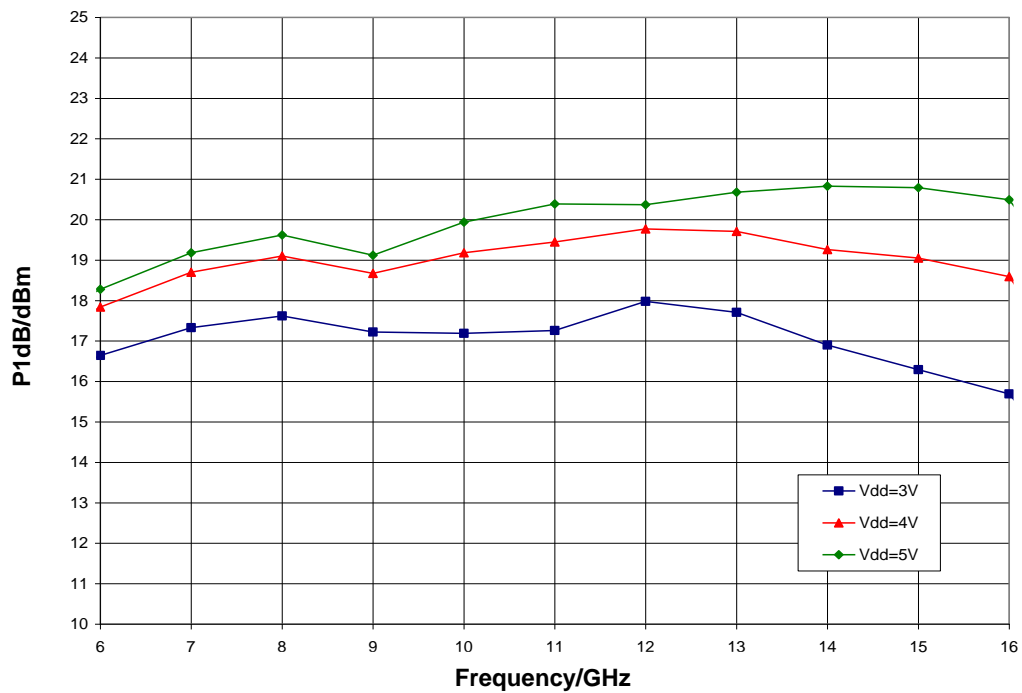

Typical Performance

Psat vs. Temperature, $V_{dd} = 5.0\text{ V}$

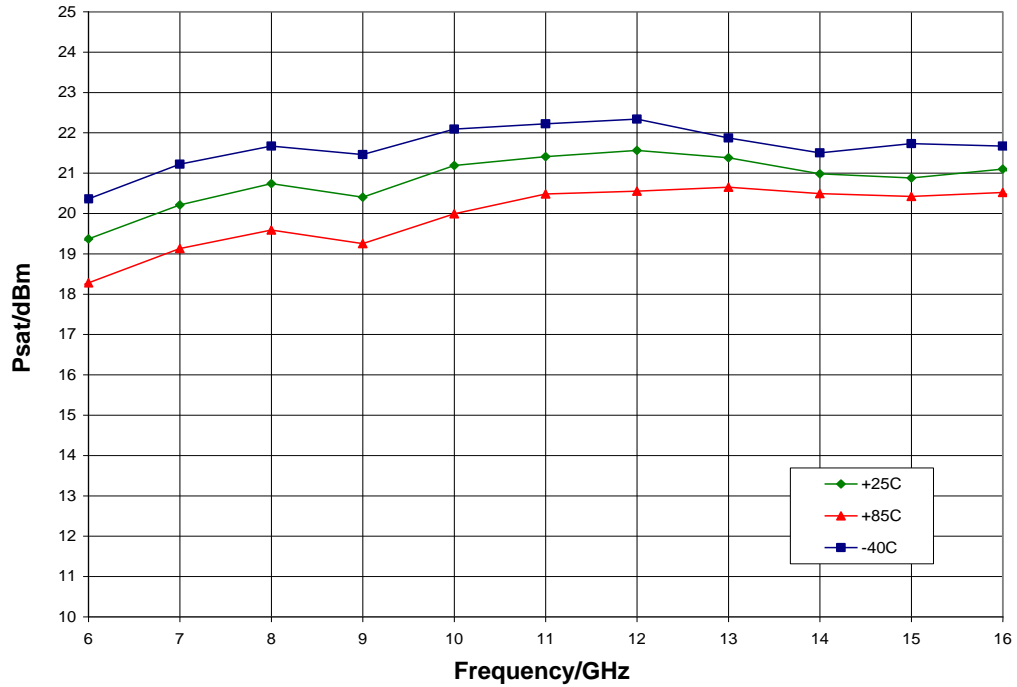

Psat vs. V_{dd} , $T_A = 25^\circ\text{C}$

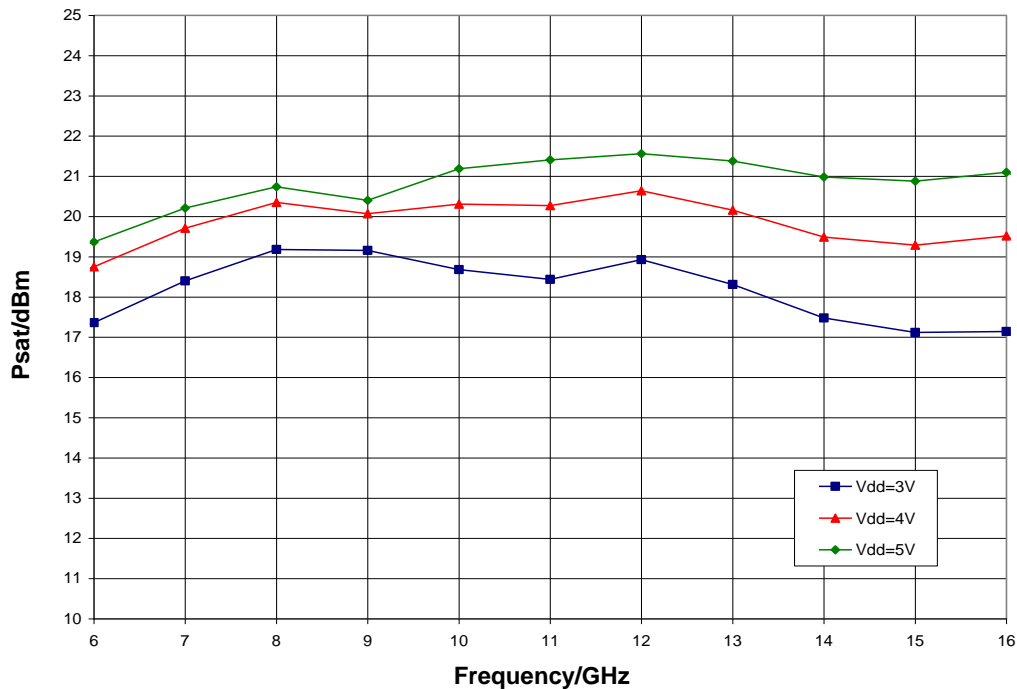

Typical Performance

Output IP3 vs. Temperature, $V_{dd} = 5.0\text{ V}$

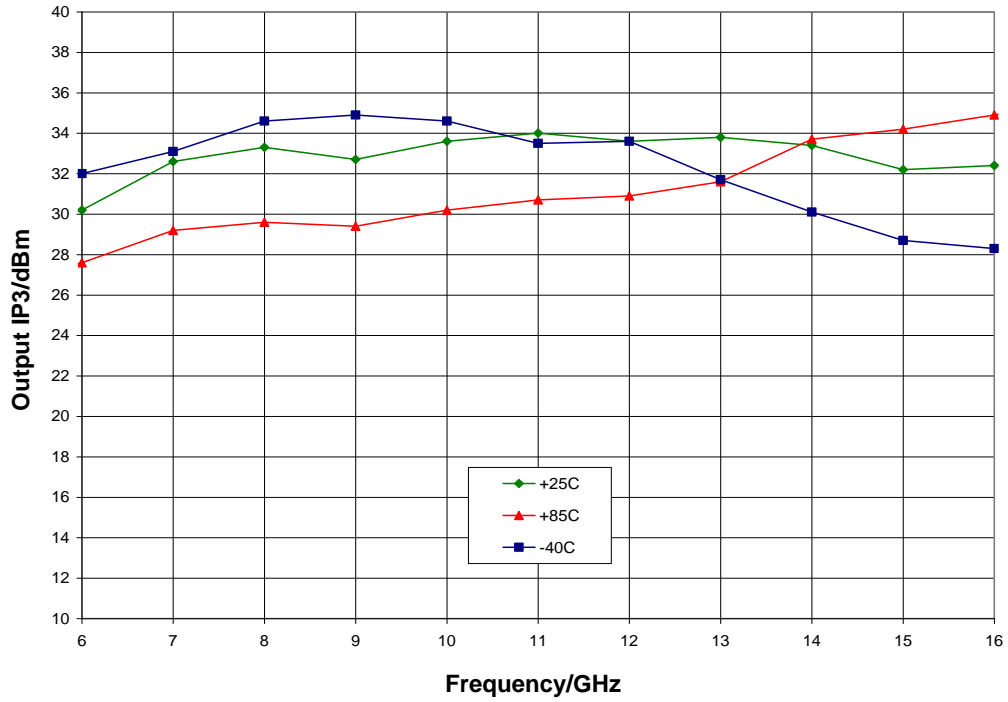

Output IP3 vs. V_{dd} , $T_A = 25^\circ\text{ C}$

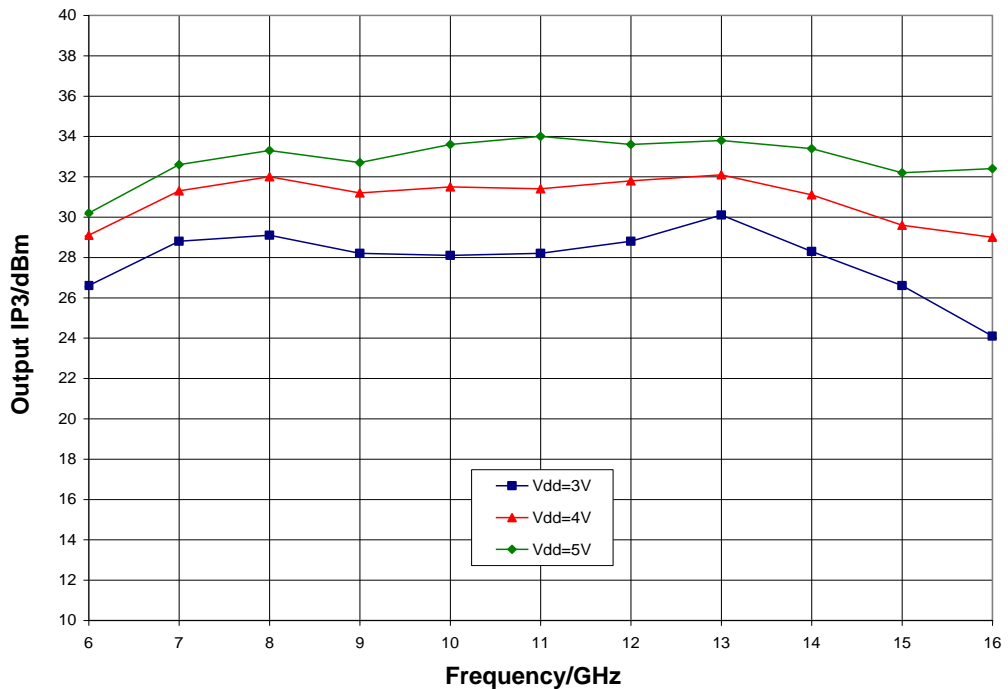

Mechanical Information

Package Information and Dimensions

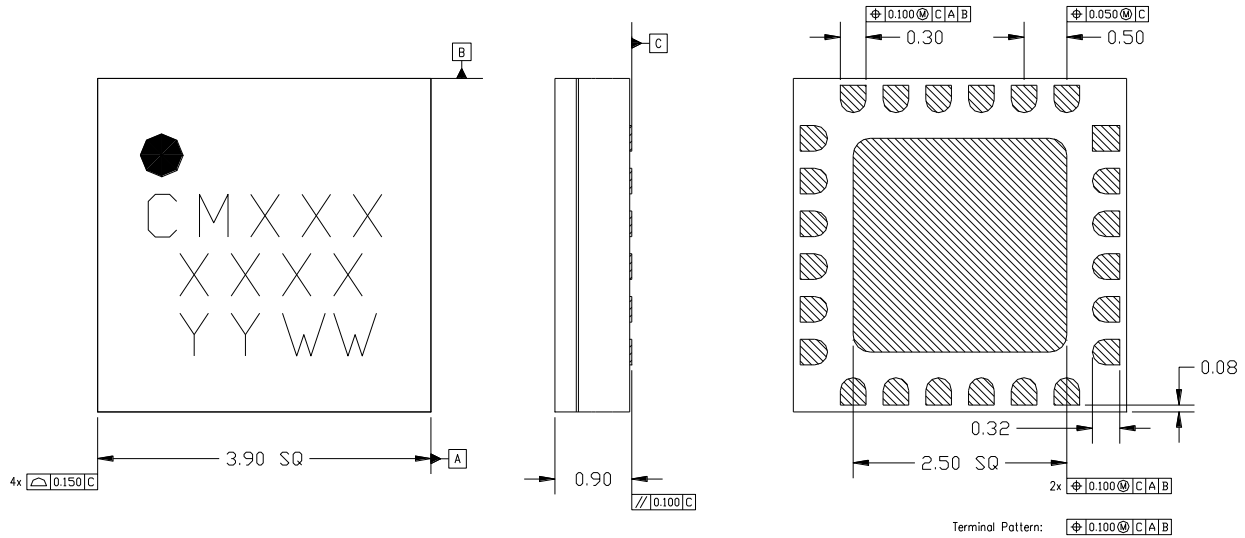

Notes:

1. All dimensions shown in mm.
2. Material: Black alumina
3. Lead finish
 - 3.1. Ni: 8.89um max, 1.27um min
 - 3.2. Pd: 0.17um max, 0.07um min
 - 3.3. Au: 0.254um max, 0.03um min
4. Marking
 - 4.1. Line 1: Part number
 - 4.1.1. Example: CMD191C4 shall be marked as CM191
 - 4.2. Line 2: Lot number
 - 4.3. Line 3: Date code - Last 2 digits of the year of manufacture followed by a 2 digit week code
5. Alternate pin #1 identifier is a single square pad
6. Alternate die paddle may have chamfered corners

Recommended PCB Land Pattern

Qorvo recommends that the user develop the land pattern that will provide the best design for proper solder reflow and device attach for their specific application. Please review Qorvo Application Note AN 105 for a recommended land pattern approach.

Recommended Solder Reflow Profile

Qorvo recommends screen printing with belt furnace reflow to ensure proper solder reflow and device attach. Please review Qorvo Application Note AN 102 for a recommended solder reflow profile.

Pin Description

Pin Diagram

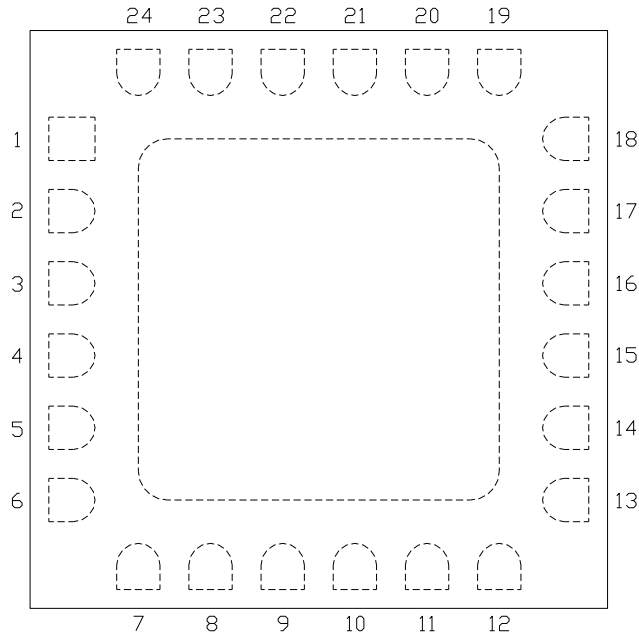

Functional Description

Pin	Function	Description	Schematic
1, 5 - 14, 18, 19, 21 - 24	N/C	No connection required These pins may be connected to RF / DC ground	
2, 4, 15, 17 and die paddle	Ground	Connect to RF / DC ground	
3	RF in	DC blocked and 50 ohm matched	
16	RF out	DC blocked and 50 ohm matched	
20	V _{dd}	Power supply voltage Decoupling and bypass caps required	

Applications Information

Application Circuit

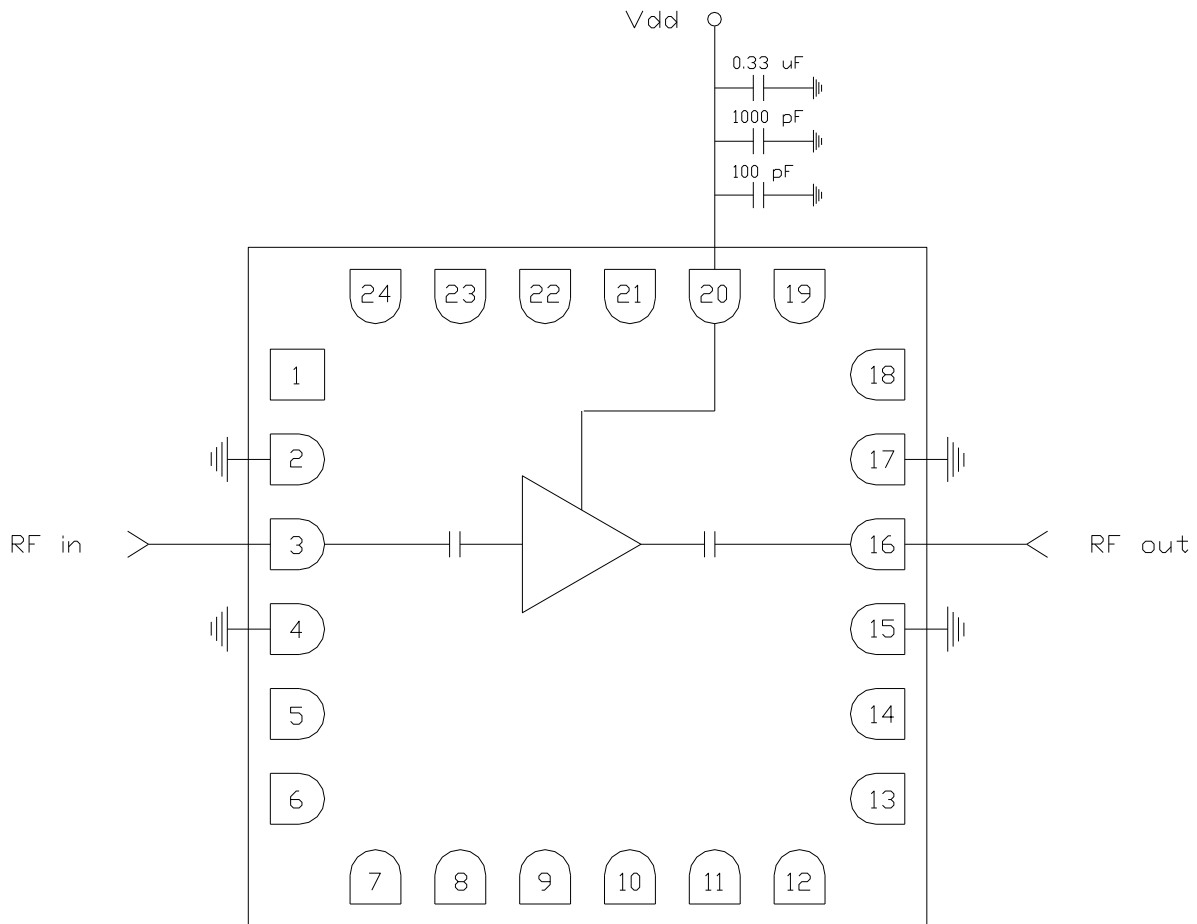

Biasing and Operation

The CMD305C4 is biased with a single 5.0 V positive drain supply.

RF power can be applied at any time.

GaAs MMIC devices are susceptible to damage from Electrostatic Discharge. Proper precautions should be observed during handling, assembly and test.

Applications Information

Evaluation Board

The circuit board shown has been developed for optimized assembly at Qorvo. A sufficient number of via holes should be used to connect the top and bottom ground planes. As surface mount processes vary, careful process development is recommended.

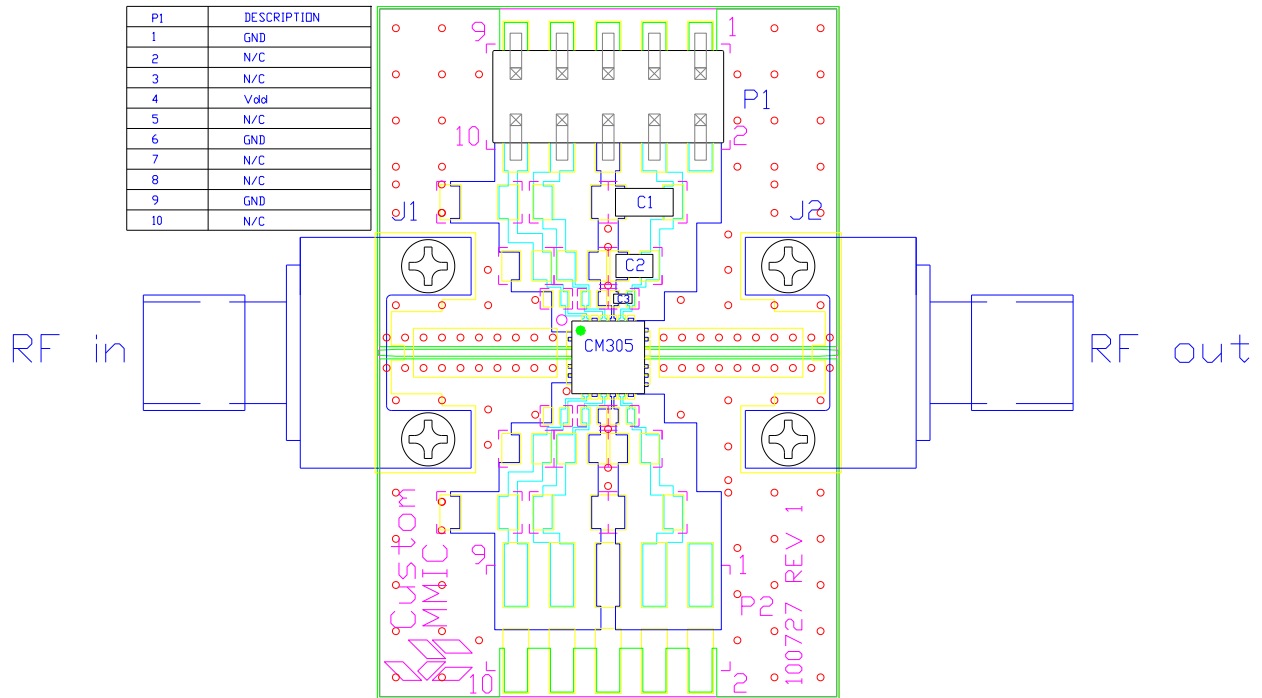

Bill of Material

Designator	Value	Description
J1, J2		SMA End Launch Connector
P1		10 Pin Header
C1	0.33 μ F	Capacitor, Tantalum
C2	1000 pF	Capacitor, 0603
C3	100 pF	Capacitor, 0402
U1		CMD305C4 Low Noise Amplifier
PCB		100727 Evaluation PCB