

Product Overview

The CMD305P3 is a broadband MMIC driver amplifier housed in a leadless 3x3 mm plastic surface mount package. The CMD305P3 is ideally suited for EW and communications systems where small size and low power consumption are needed. The broadband device delivers 18 dB of gain and +20.5 dBm saturated output power at 21% PAE from a single 5 V supply. The CMD305P3 is a 50 ohm matched design eliminating the need for external DC blocks and RF port matching.

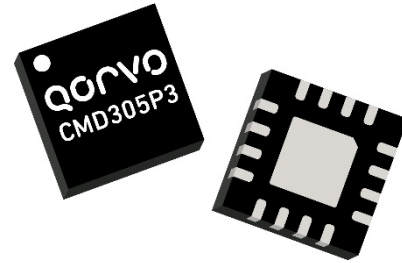

Functional Block Diagram

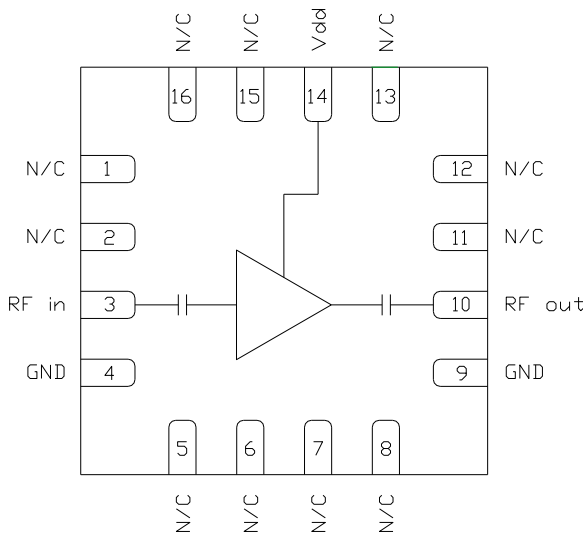

Key Features

- Broadband Performance
- High Output Power
- Low Current Consumption
- Single Positive Supply Voltage
- Pb-Free RoHS Compliant 3x3 QFN Package

Ordering Information

Part No.	Description
CMD305P3	6-14 GHz Driver Amplifier

Electrical Performance ($V_{dd} = 5.0 \text{ V}$, $T_A = 25^\circ \text{C}$, $F = 10 \text{ GHz}$)

Parameter	Min	Typ	Max	Units
Frequency Range		6 - 14		GHz
Gain		18		dB
Input Return Loss		19		dB
Output Return Loss		8		dB
Output P1dB		19		dBm
Output Psat		20.5		dBm
Output IP3		31.5		dBm
Supply Current		100		mA

Absolute Maximum Ratings

Parameter	Rating
Drain Voltage, V_{dd}	5.5 V
RF Input Power	+10 dBm
Channel Temperature, T_{ch}	150° C
Power Dissipation, P_{diss}	650 mW
Thermal Resistance, Q_{JC}	100° C/W
Operating Temperature	-40 to 85° C
Storage Temperature	-55 to 150° C

Exceeding any one or combination of the maximum ratings may cause permanent damage to the device.

Recommended Operating Conditions

Parameter	Min	Typ	Max	Units
V_{dd}	3.0	5.0	5.25	V
I_{dd}		100		mA

Electrical performance is measured at specific test conditions. Electrical specifications are not guaranteed over all recommended operating conditions.

Drain Current vs. Drain Voltage

V_{dd} (V)	I_{dd} (mA)
3.0	65
4.0	85
5.0	100

Electrical Specifications ($V_{dd} = 5.0$ V, $T_A = 25^\circ$ C)

Parameter	Min	Typ	Max	Min	Typ	Max	Units
Frequency Range		6 - 9			9 - 14		GHz
Gain	15.5	19		15	18		dB
Noise Figure		6			4		dB
Input Return Loss		12			15		dB
Output Return Loss		9			10		dB
Output P1dB	15.5	19		15.5	19		dBm
Output Psat		20			20.5		dBm
Output IP3		31			31		dBm
Supply Current	70	100	130	70	100	130	mA
Gain Temperature Coefficient		0.016			0.016		dB/°C

Typical Performance

Broadband Performance, $V_{dd} = 5.0 \text{ V}$, $T_A = 25^\circ \text{ C}$

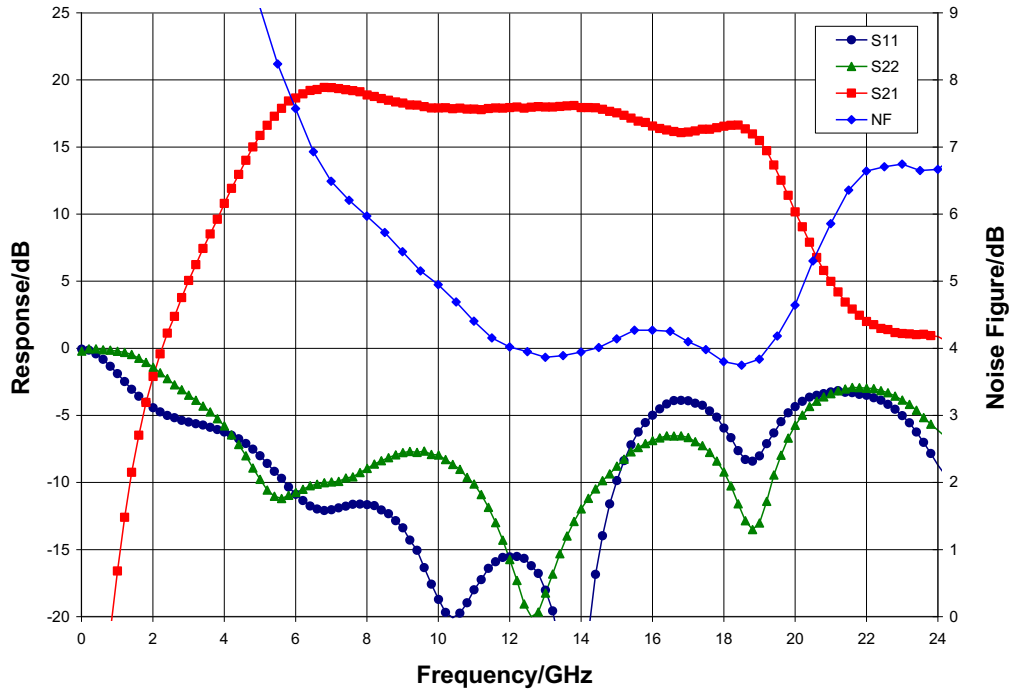

Narrow-band Performance, $V_{dd} = 5.0 \text{ V}$, $T_A = 25^\circ \text{ C}$

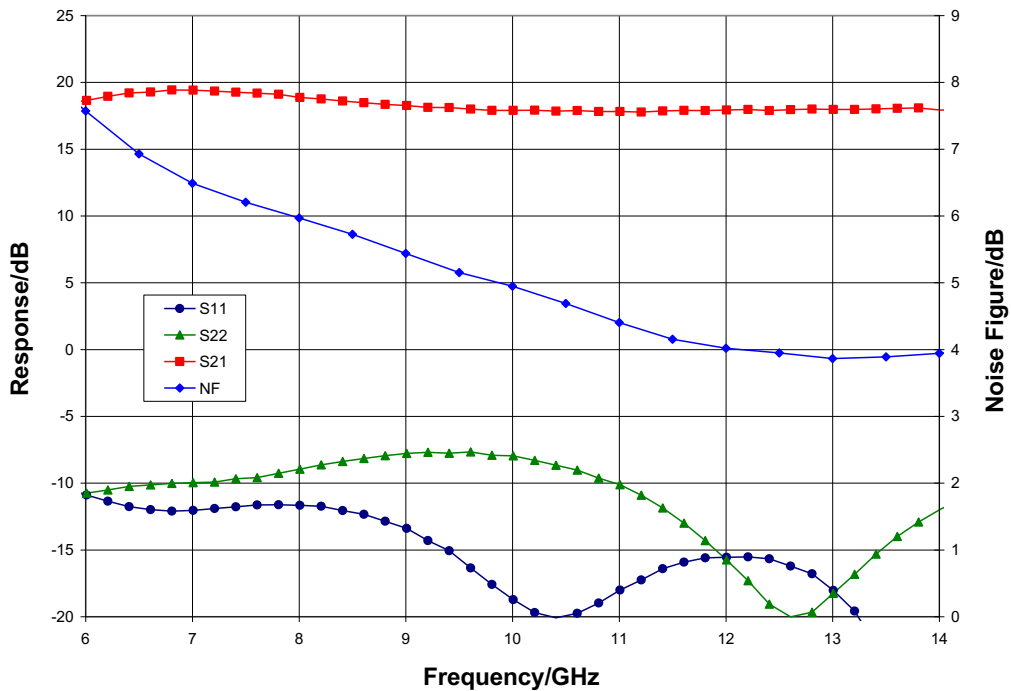

Typical Performance

Gain vs. Temperature, $V_{dd} = 5.0\text{ V}$

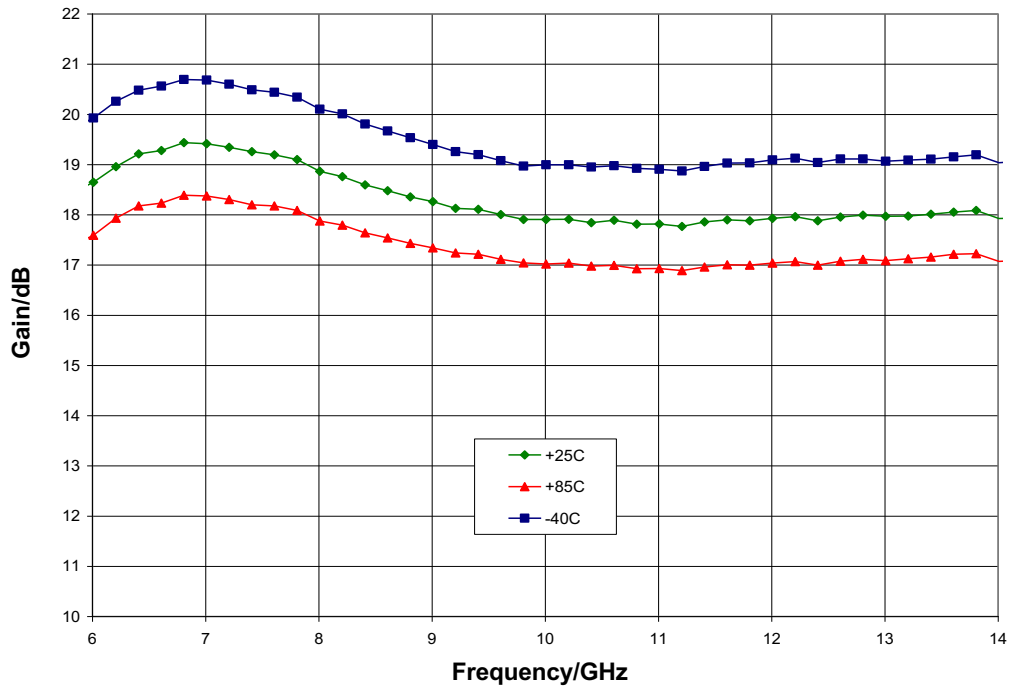

Gain vs. V_{dd} , $T_A = 25^\circ\text{ C}$

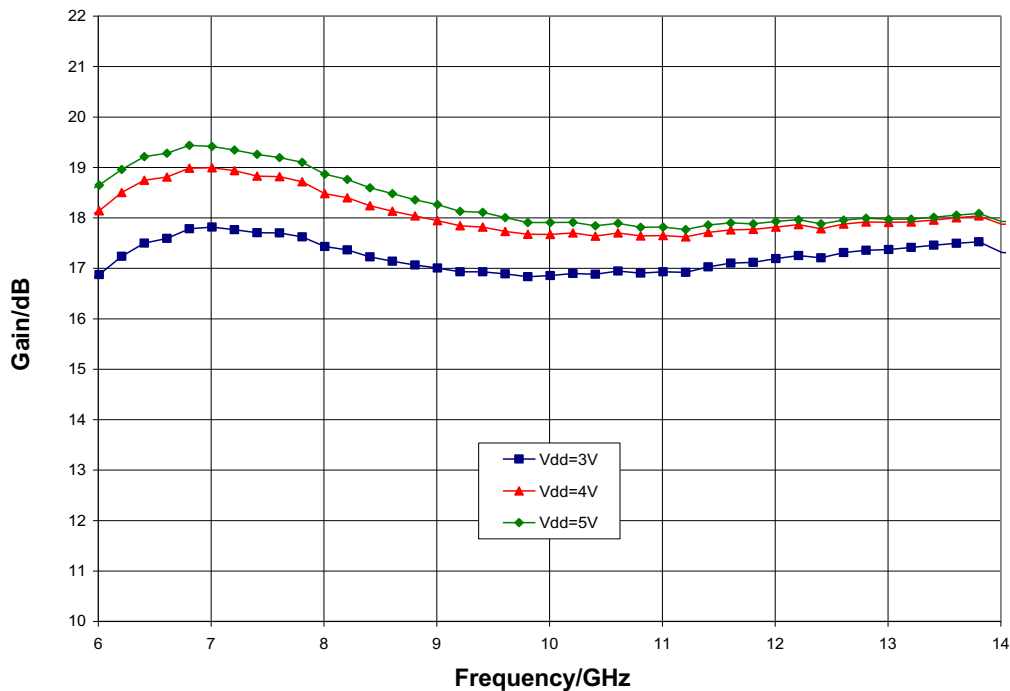

Typical Performance

Noise Figure vs. Temperature, $V_{dd} = 5.0\text{ V}$

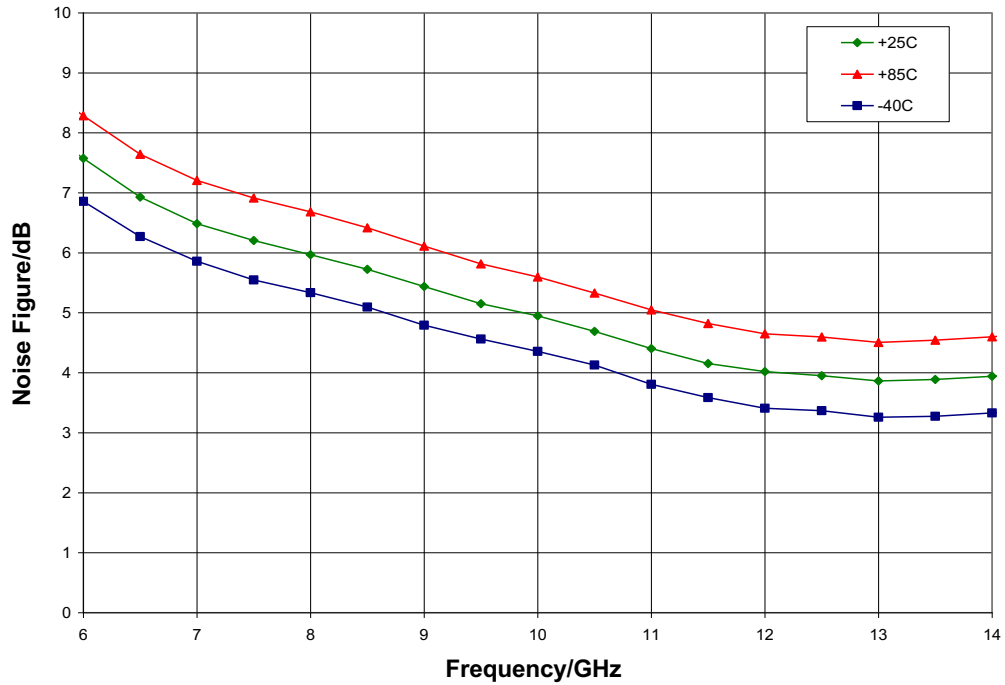

Noise Figure vs. V_{dd} , $T_A = 25^\circ\text{ C}$

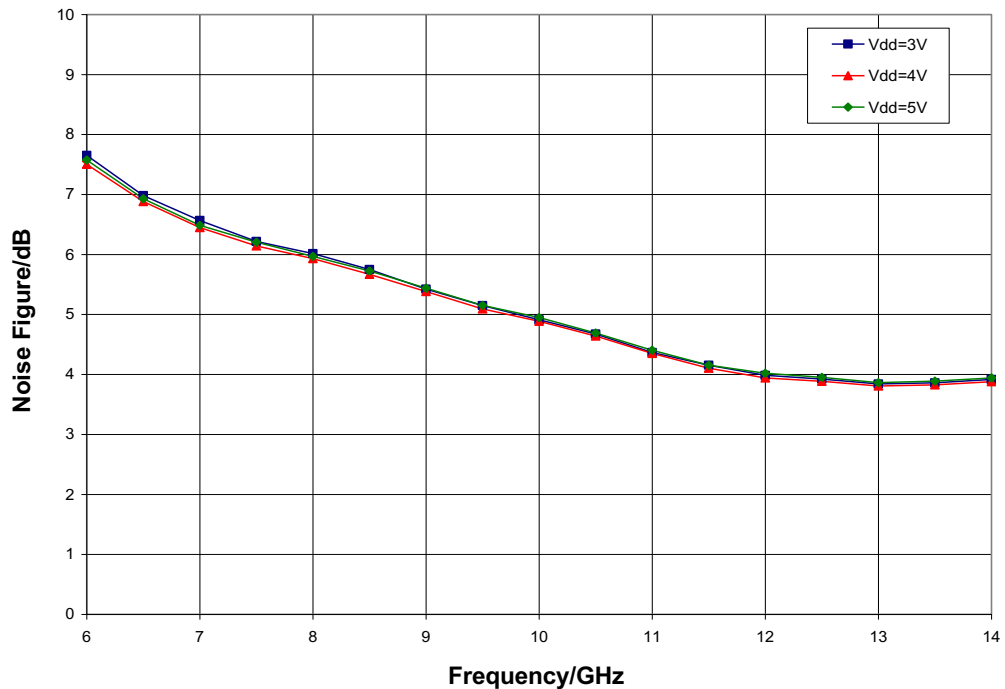

Typical Performance

P1dB vs. Temperature, $V_{dd} = 5.0\text{ V}$

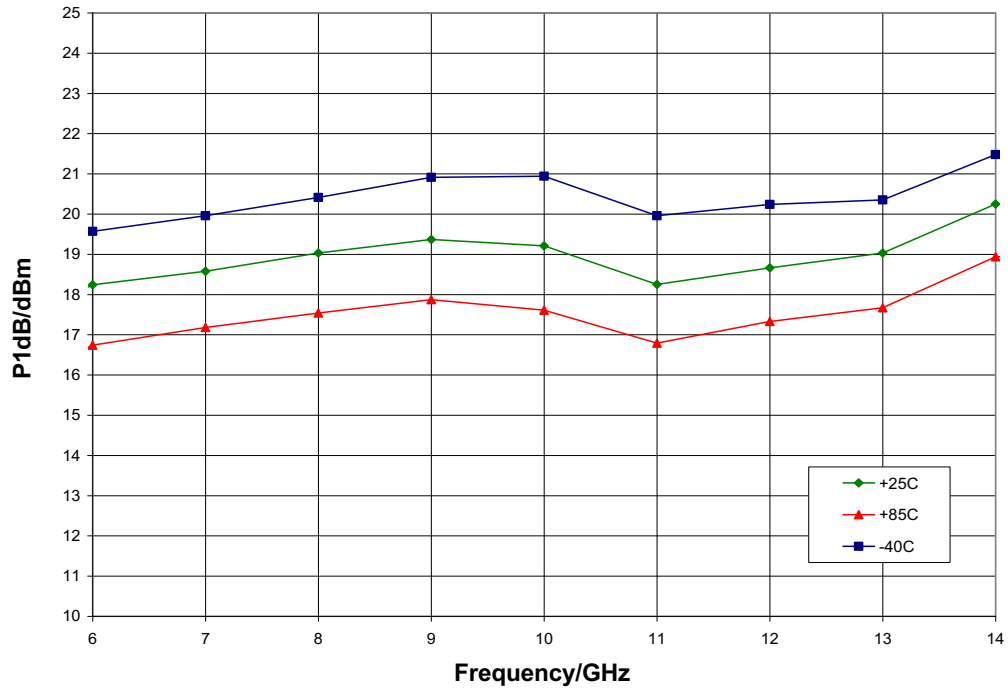

P1dB vs. V_{dd} , $T_A = 25^\circ\text{C}$

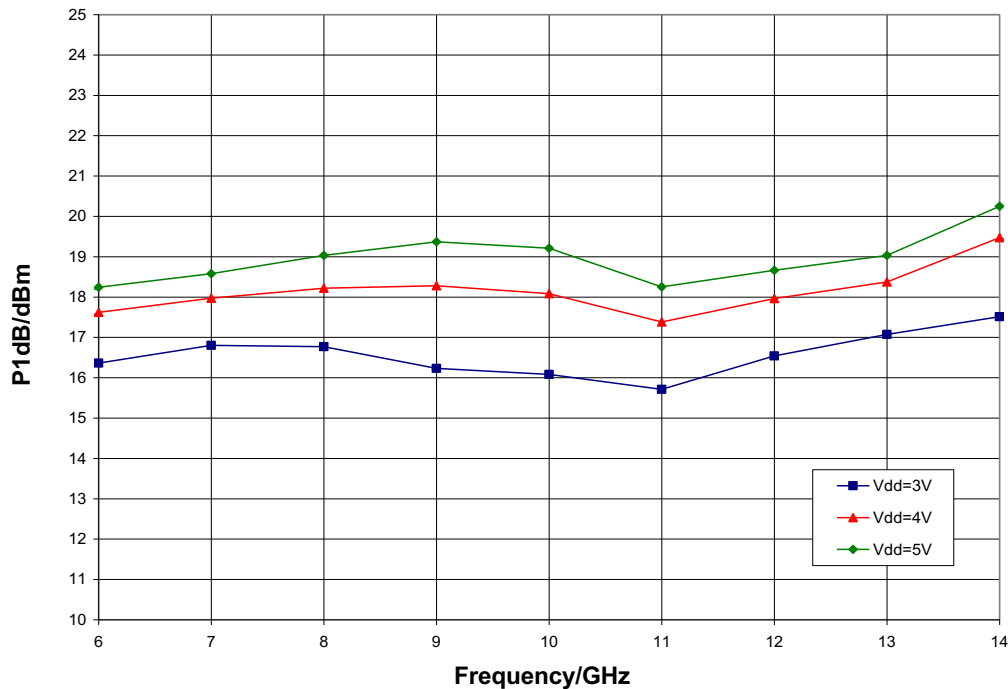

Typical Performance

Psat vs. Temperature, $V_{dd} = 5.0\text{ V}$

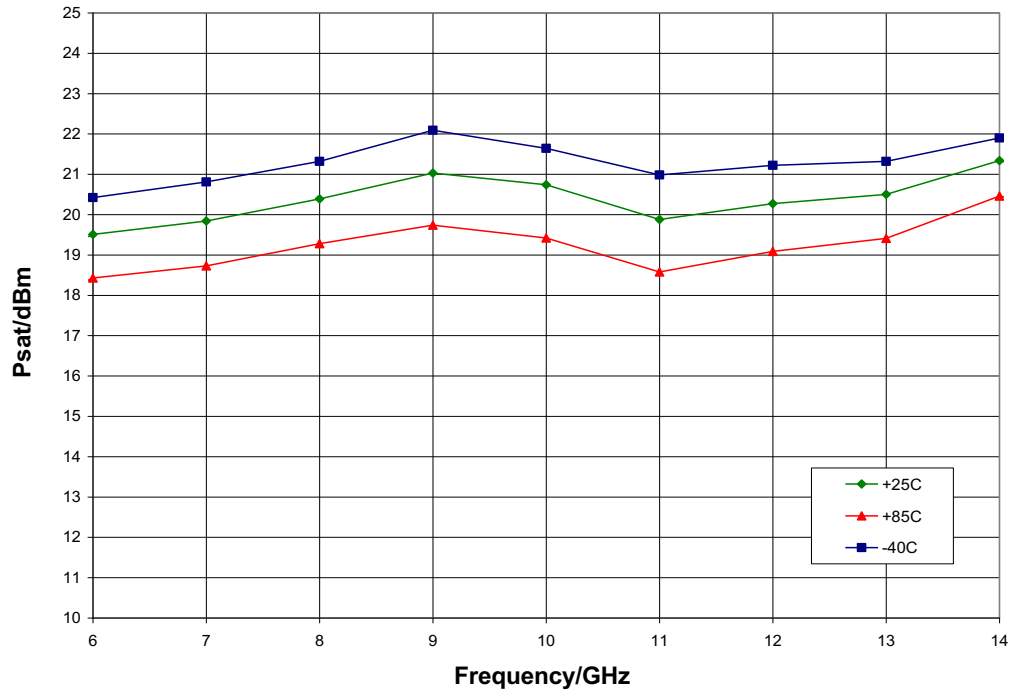

Psat vs. V_{dd} , $T_A = 25^\circ\text{ C}$

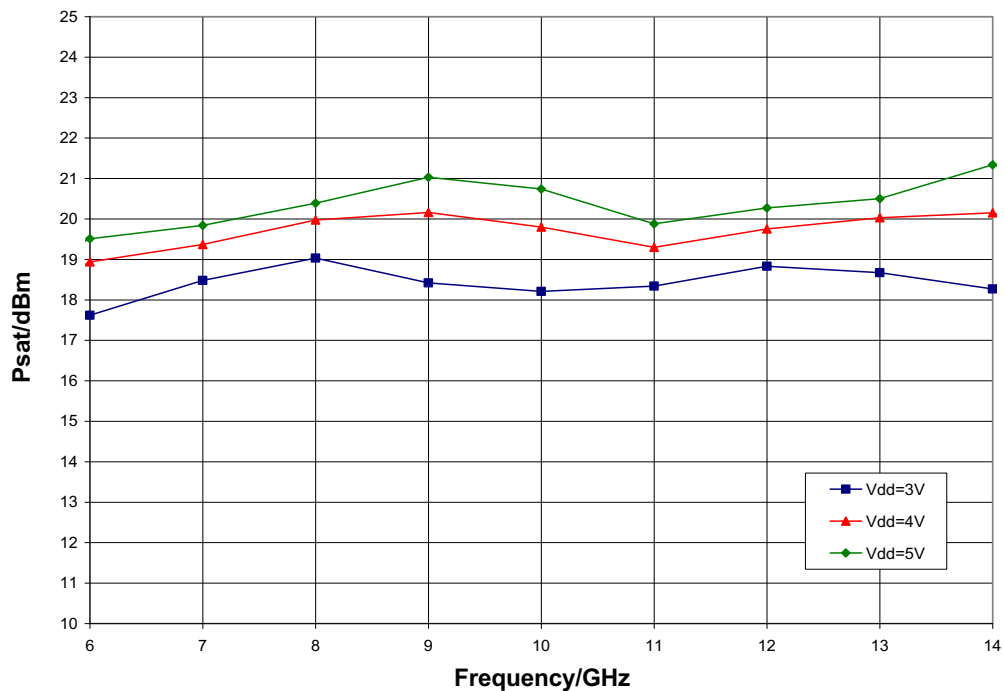

Typical Performance

Output IP3 vs. Temperature, $V_{dd} = 5.0\text{ V}$

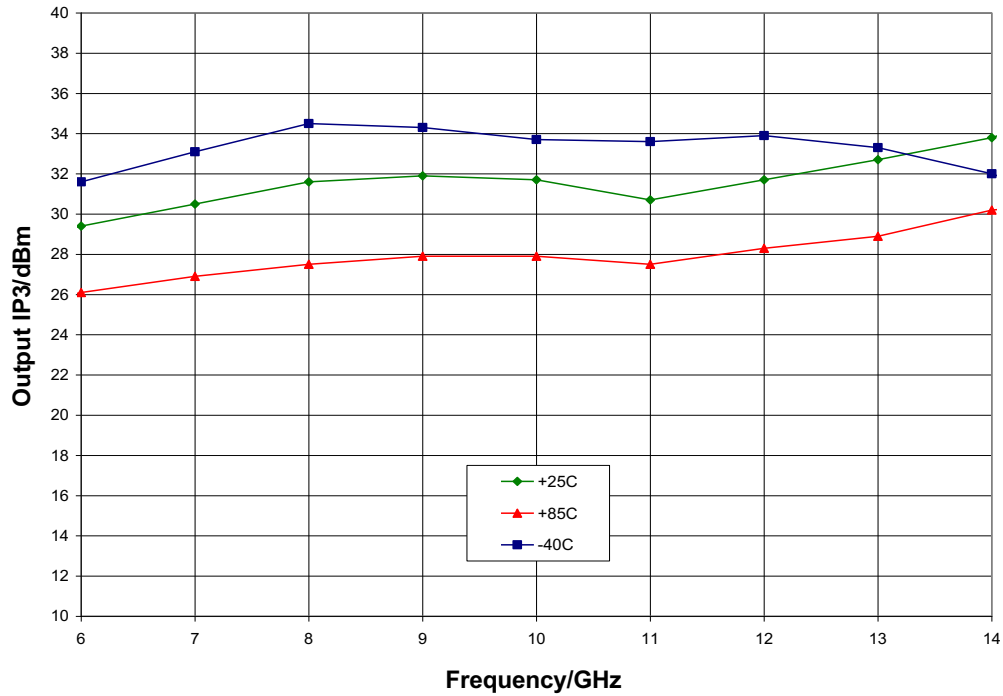

Output IP3 vs. V_{dd} , $T_A = 25^\circ\text{ C}$

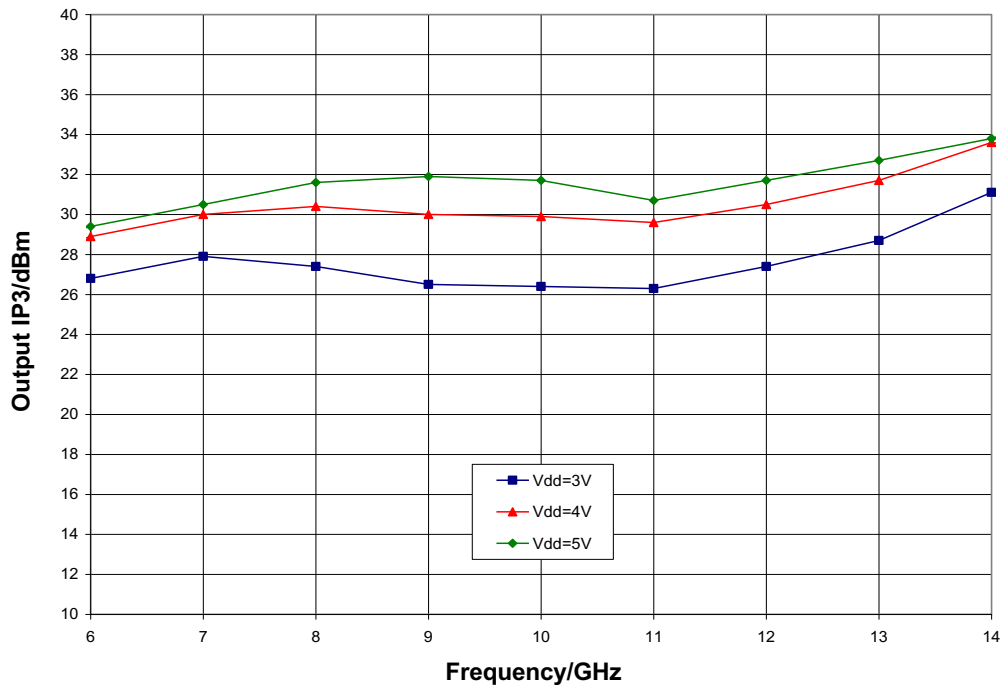

Mechanical Information

Package Information and Dimensions

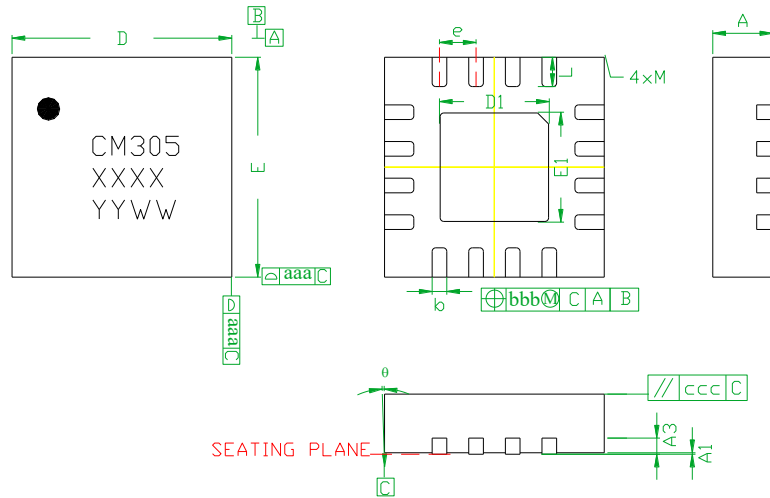

SYMBOLS	DIMENSIONS IN MILLIMETERS		
	MIN	NOM	MAX
A	0.80	0.90	1.00
A1	0	0.02	0.05
A3	---	0.25REF.	---
b	0.18	0.23	0.30
D	2.85	3.00	3.15
D1	---	1.5BSC	---
E	2.85	3.00	3.15
E1	---	1.5BSC	---
e	---	0.50BSC	---
L	0.30	0.40	0.50
theta	0	---	12
aaa	---	0.25	---
bbb	---	0.10	---
ccc	---	0.10	---
M	---	---	0.05

Notes:

1. Dimensions are in millimeters
2. RoHs compliant mold compound
3. Lead frame material: Copper alloy
4. Lead finish: 100% matte Sn
5. Indicated dimension/tolerance applies to leads and exposed pads

Recommended PCB Land Pattern

Qorvo recommends that the user develop the land pattern that will provide the best design for proper solder reflow and device attach for their specific application. Please review Qorvo Application Note AN 105 for a recommended land pattern approach.

Recommended Solder Reflow Profile

Qorvo recommends screen printing with belt furnace reflow to ensure proper solder reflow and device attach. Please review Qorvo Application Note AN 102 for a recommended solder reflow profile.

Pin Description

Pin Diagram

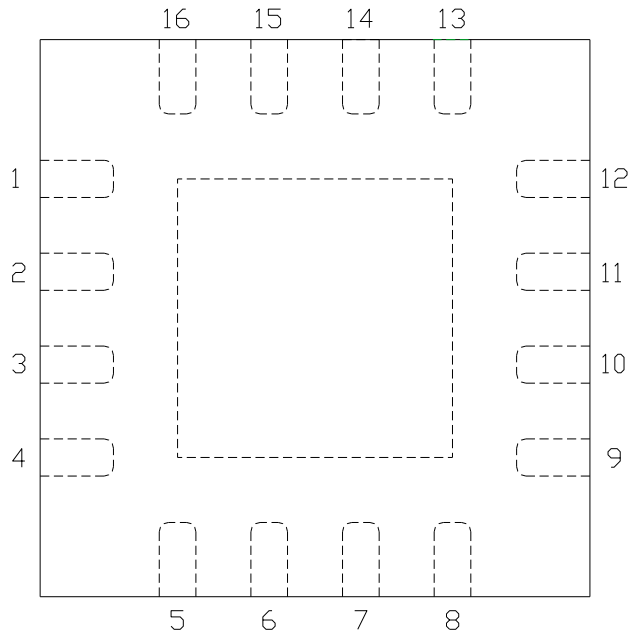

Functional Description

Pin	Function	Description	Schematic
1, 2, 5 - 8, 11 - 13, 15, 16	N/C	No connection required These pins may be connected to RF / DC ground	
3	RF in	DC blocked and 50 ohm matched	
10	RF out	DC blocked and 50 ohm matched	
14	V _{dd}	Power supply voltage Decoupling and bypass caps required	
4, 9 and die paddle	Ground	Connect to RF / DC ground	

Applications Information

Application Circuit

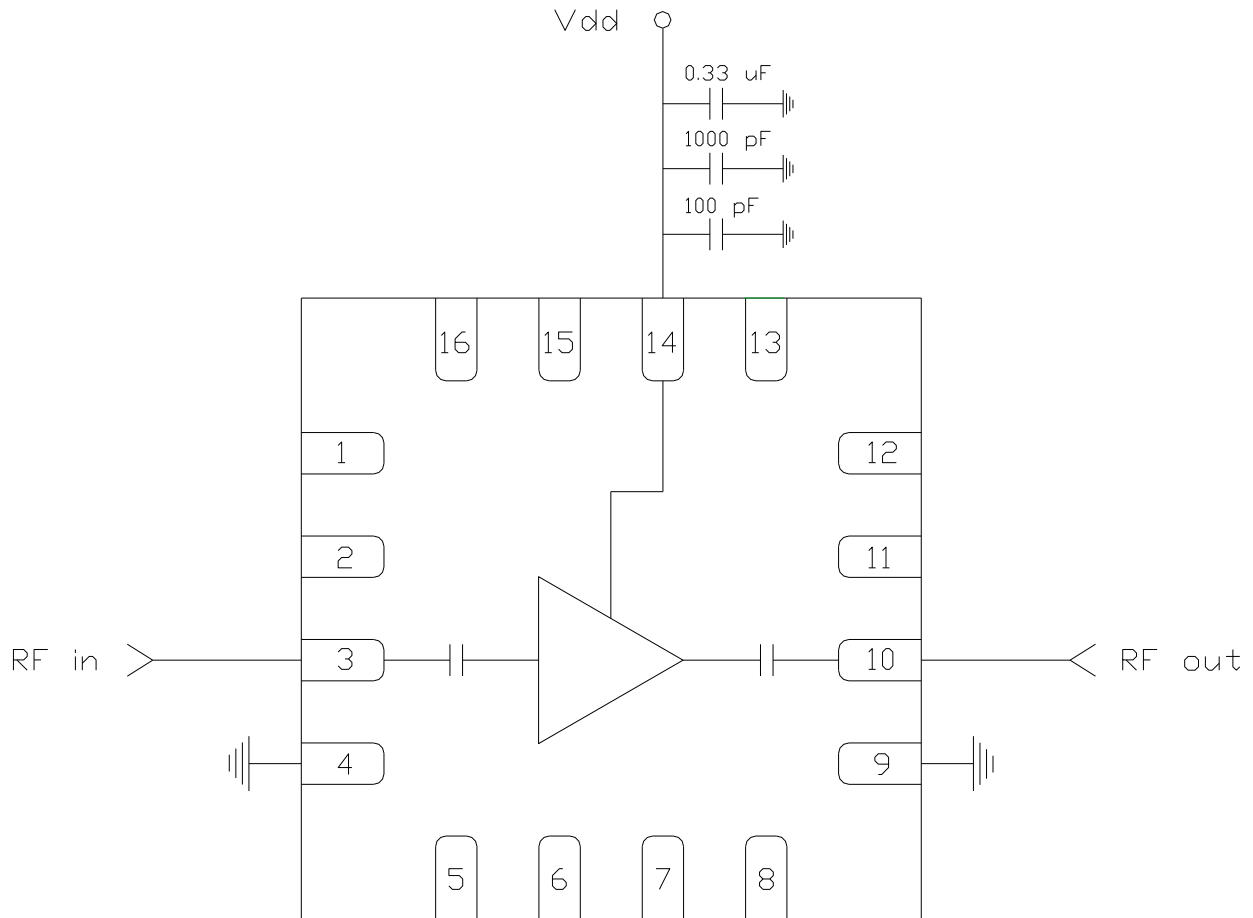

Biasing and Operation

The CMD305P3 is biased with a single 5.0 V positive drain supply.

RF power can be applied at any time.

GaAs MMIC devices are susceptible to damage from Electrostatic Discharge. Proper precautions should be observed during handling, assembly and test.

Applications Information

Evaluation Board

The circuit board shown has been developed for optimized assembly at Qorvo. A sufficient number of via holes should be used to connect the top and bottom ground planes. As surface mount processes vary, careful process development is recommended.

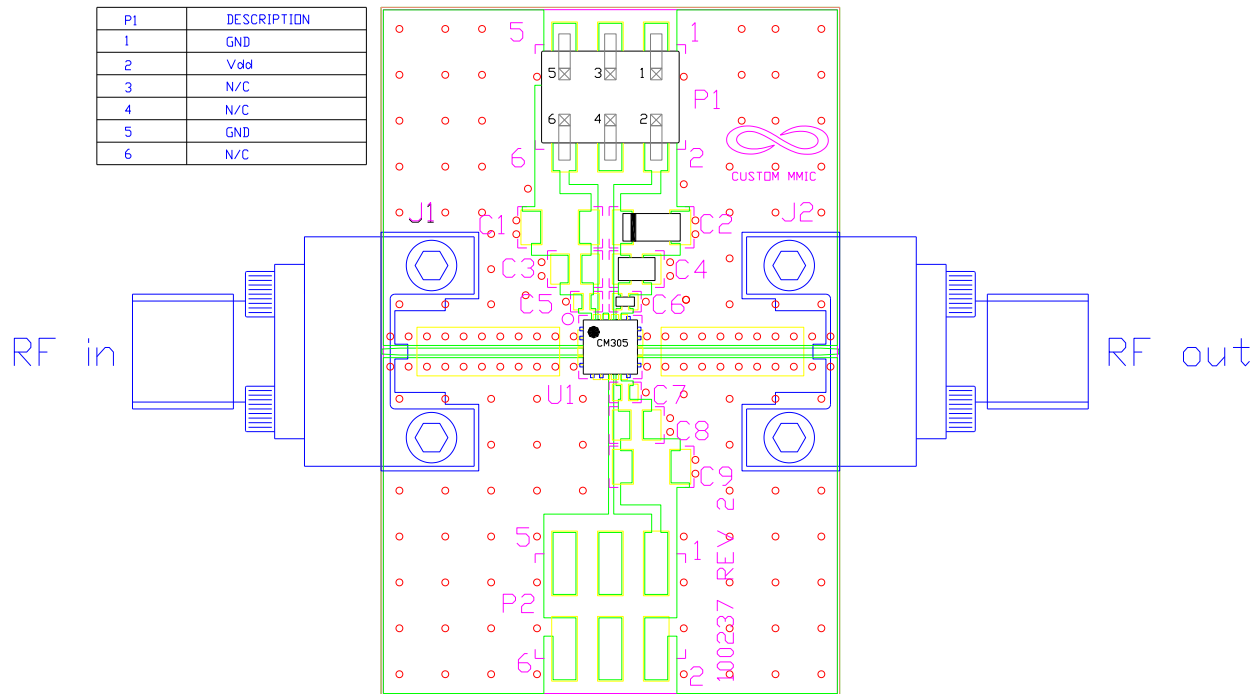

Bill of Material

Designator	Value	Description
J1, J2		SMA End Launch Connector
P1		6 Pin Header
C2	0.33 μ F	Capacitor, Tantalum
C4	1000 pF	Capacitor, 0603
C6	100 pF	Capacitor, 0402
U1		CMD305P3 Low Noise Amplifier
PCB		100237 Evaluation PCB