

Product Overview

The CMD308P4 is a broadband MMIC low noise amplifier housed in a leadless 4x4 mm plastic surface mount QFN package. The CMD308P4 is ideally suited for microwave radios and S and C-band applications where high gain, low noise figure and low power consumption are needed. The broadband device delivers 31 dB of gain with a corresponding output 1 dB compression point of +12 dBm and a noise figure of 1.6 dB. The CMD308P4 is a 50 ohm matched design eliminating the need for external DC blocks and RF port matching.

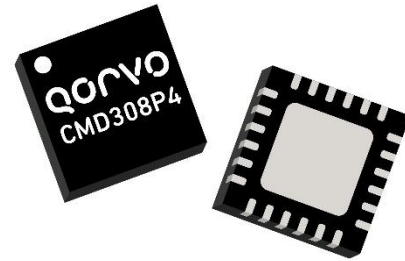

Functional Block Diagram

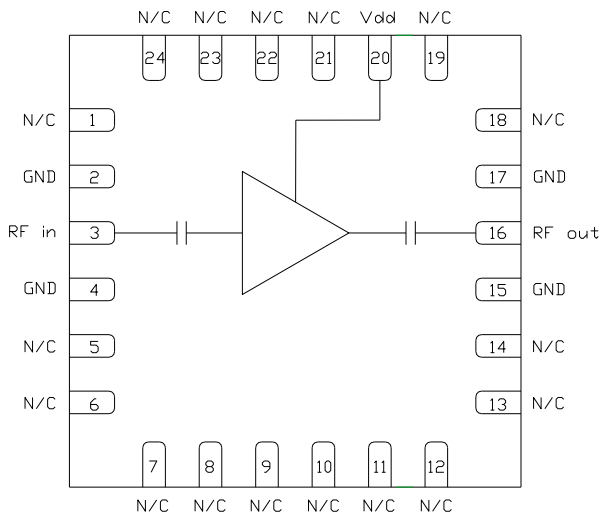

Key Features

- Low Noise Figure
- High Gain Broadband Performance
- Low Current Consumption
- Single Positive Bias
- Pb-Free RoHs Compliant 4x4 QFN Package

Ordering Information

Part No.	Description
CMD308P4	100 pcs on 7" reel
CMD308P4-EVB	Evaluation Board

Electrical Performance ($V_{dd} = 4.0\text{ V}$, $T_A = 25^\circ\text{C}$, $F = 4\text{ GHz}$)

Parameter	Min	Typ	Max	Units
Frequency Range		2 - 6		GHz
Gain		31		dB
Noise Figure		1.6		dB
Input Return Loss		18		dB
Output Return Loss		14		dB
Output P1dB		12		dBm
Supply Current		45		mA

Absolute Maximum Ratings

Parameter	Rating
Drain Voltage, V_{dd}	5.5 V
RF Input Power	+20 dBm
Channel Temperature, T_{ch}	150° C
Power Dissipation, P_{diss}	494 mW
Thermal Resistance, Q_{JC}	131° C/W
Operating Temperature	-40 to 85° C
Storage Temperature	-55 to 150° C

Exceeding any one or combination of the maximum ratings may cause permanent damage to the device.

Recommended Operating Conditions

Parameter	Min	Typ	Max	Units
V_{dd}	3.0	4.0	5.0	V
I_{dd}		45		mA

Electrical performance is measured at specific test conditions. Electrical specifications are not guaranteed over all recommended operating conditions.

Electrical Specifications ($V_{dd} = 4.0\text{ V}$, $T_A = 25^\circ\text{C}$)

Parameter	Min	Typ	Max	Min	Typ	Max	Units
Frequency Range		2 - 4			4 - 6		GHz
Gain	28	31		25	30		dB
Noise Figure		1.6	2.2		1.7	2.3	dB
Input Return Loss		15			18		dB
Output Return Loss		13			13		dB
Output P1dB		12.5			13		dBm
Output IP3		22.5			23.5		dBm
Supply Current	30	45	60	30	45	60	mA
Gain Temperature Coefficient		0.015			0.015		dB/°C
Noise Figure Temperature Coefficient		0.007			0.007		dB/°C

Typical Performance

Broadband Performance, $V_{dd} = 4.0\text{ V}$, $T_A = 25^\circ\text{C}$

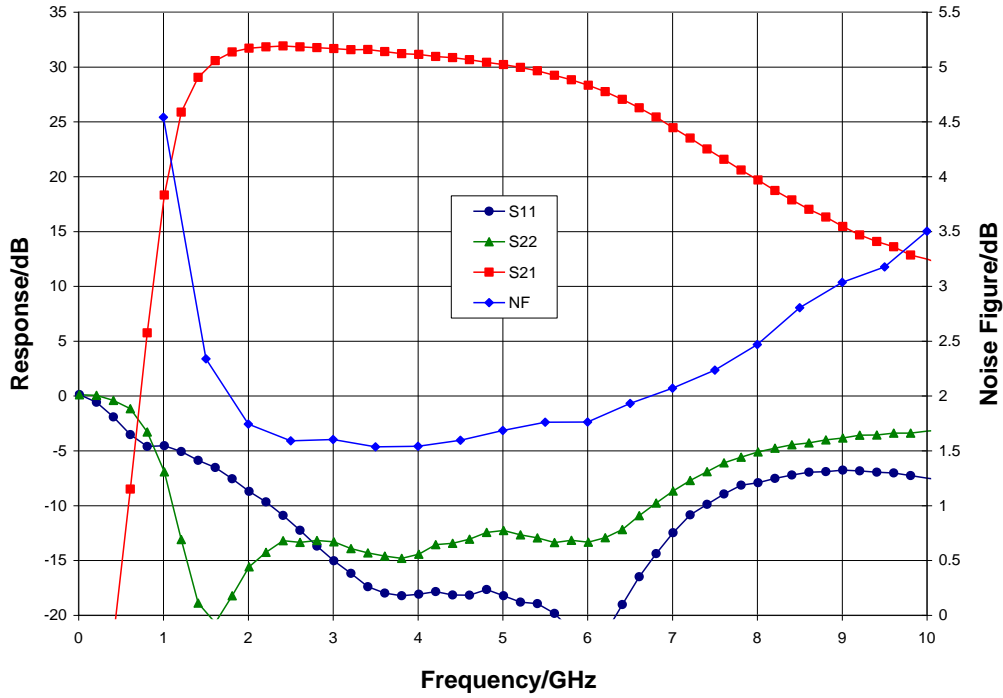

Narrow-band Performance, $V_{dd} = 4.0\text{ V}$, $T_A = 25^\circ\text{C}$

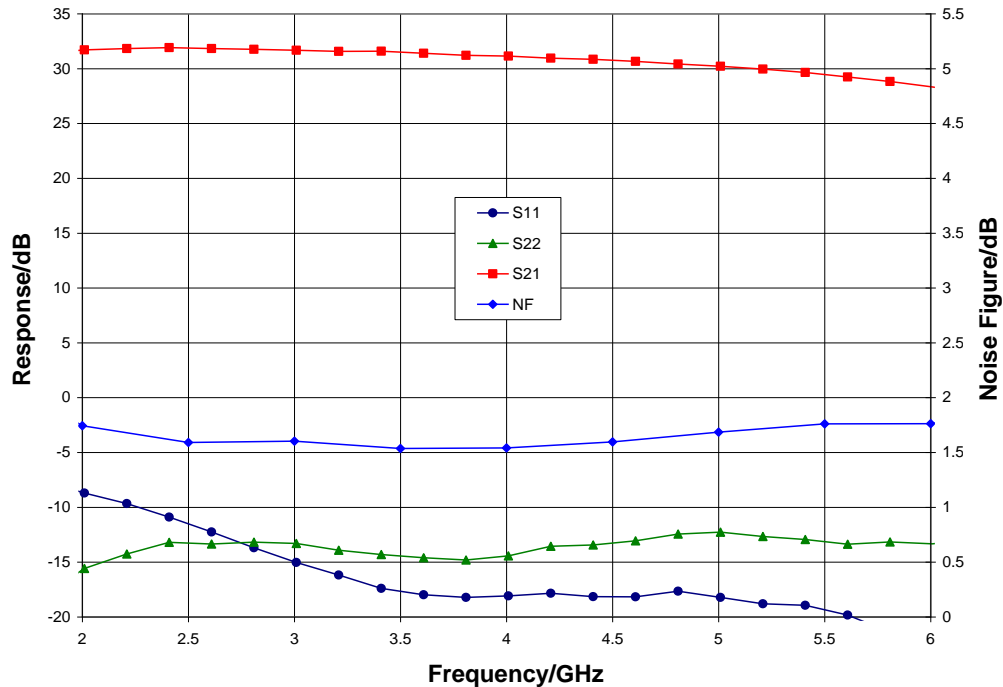

Typical Performance

Gain vs. Temperature, $V_{dd} = 4.0\text{ V}$

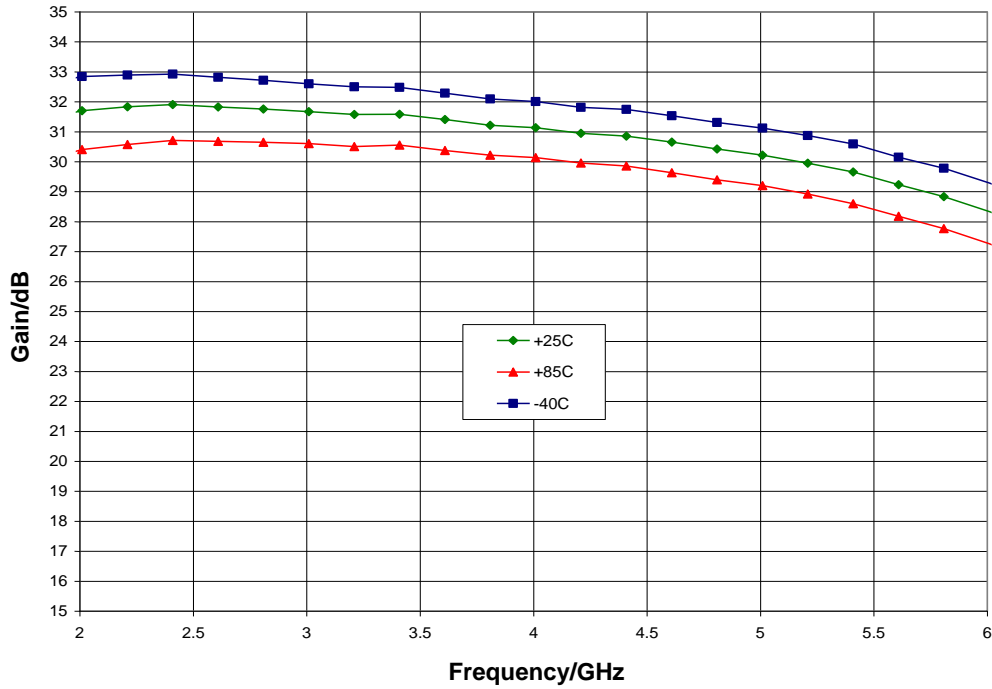

Gain vs. V_{dd} , $T_A = 25^\circ\text{ C}$

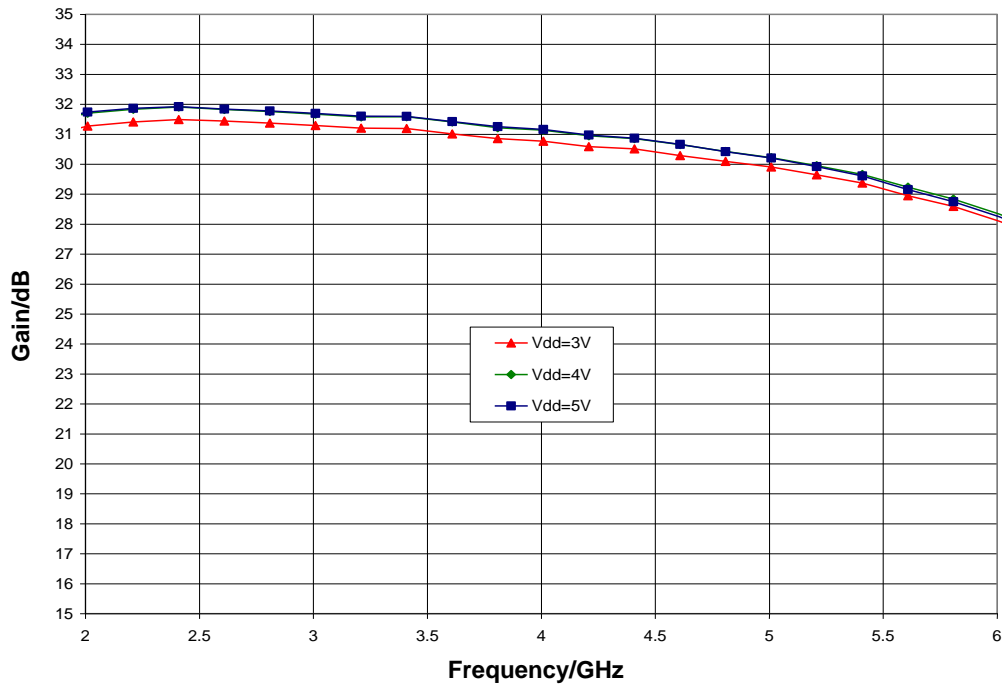

Typical Performance

Noise Figure vs. Temperature, $V_{dd} = 4.0\text{ V}$

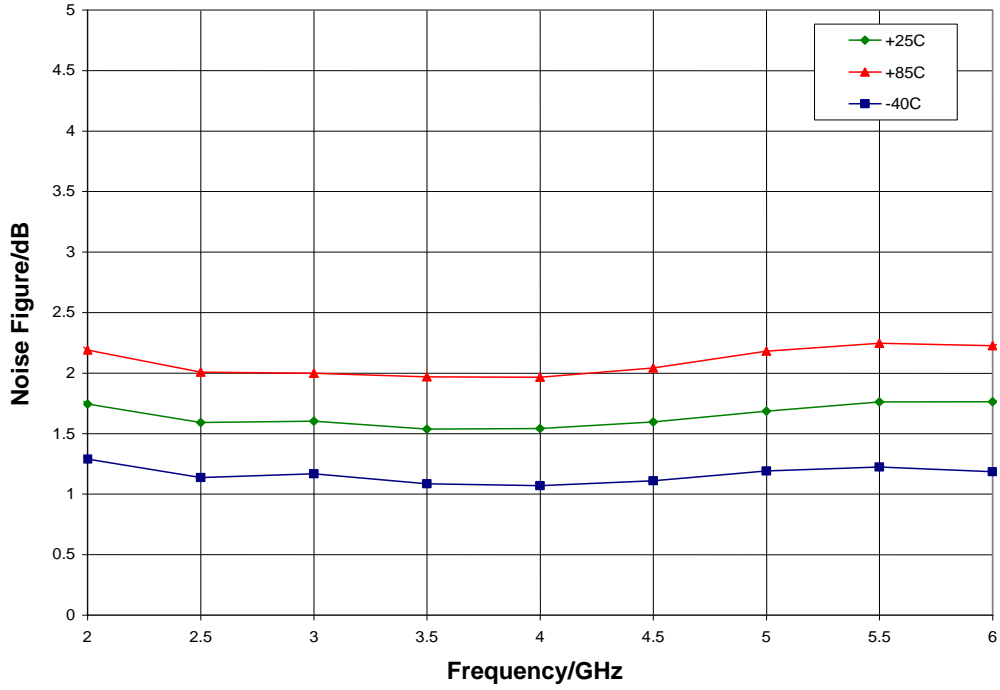

Noise Figure vs. V_{dd} , $T_A = 25^\circ\text{ C}$

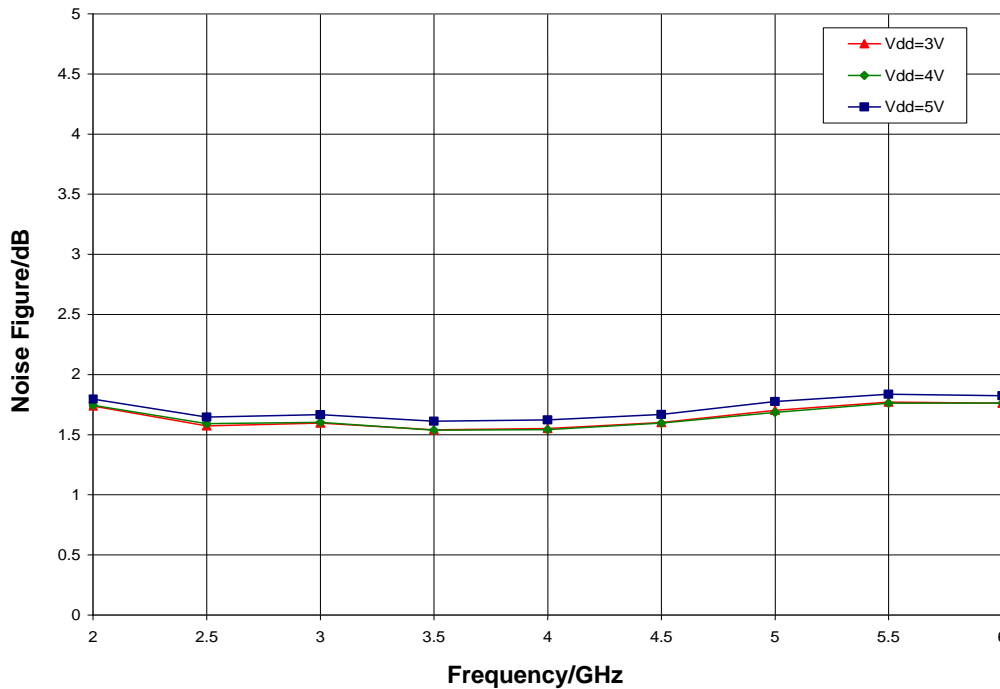

Typical Performance

P1dB vs. Temperature, $V_{dd} = 4.0\text{ V}$

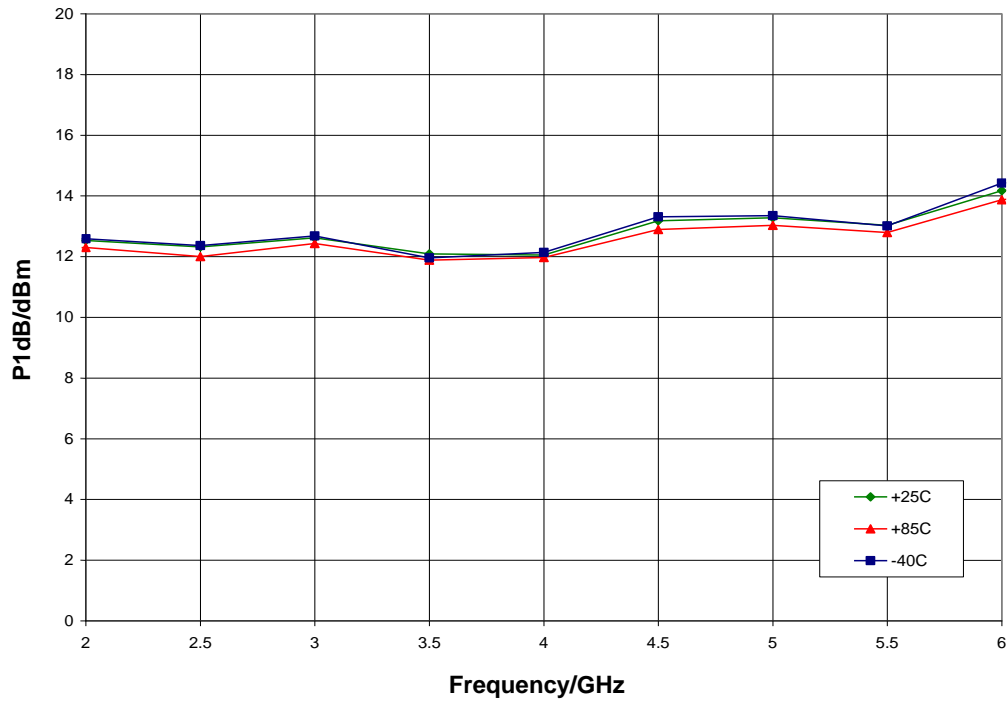

P1dB vs. V_{dd} , $T_A = 25^\circ\text{C}$

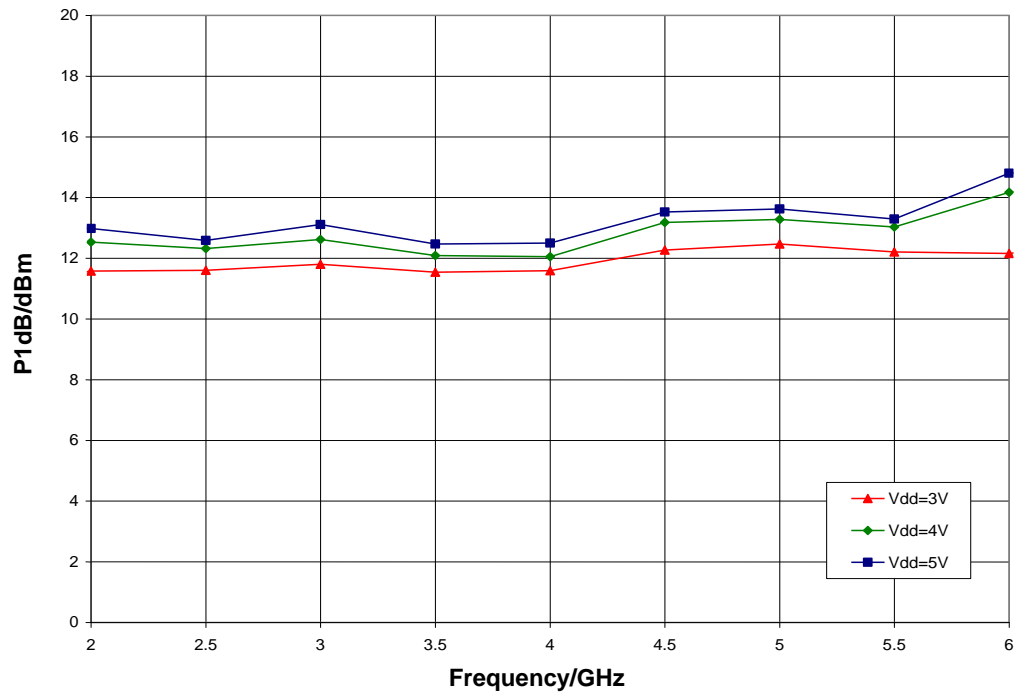

Typical Performance

Psat vs. Temperature, $V_{dd} = 4.0\text{ V}$

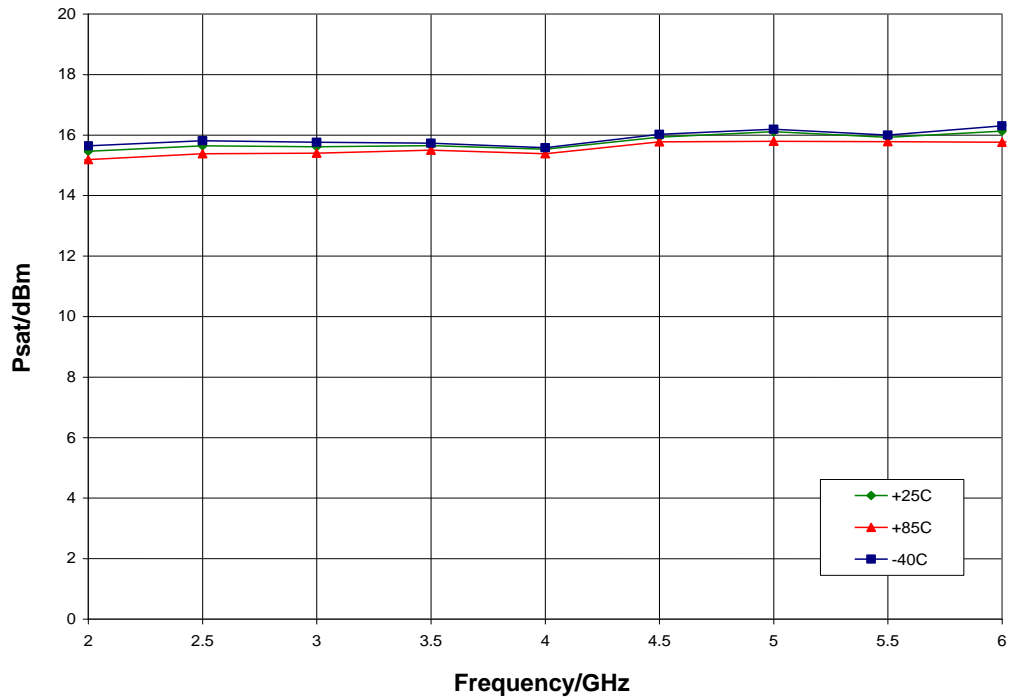

Psat vs. V_{dd} , $T_A = 25^\circ\text{ C}$

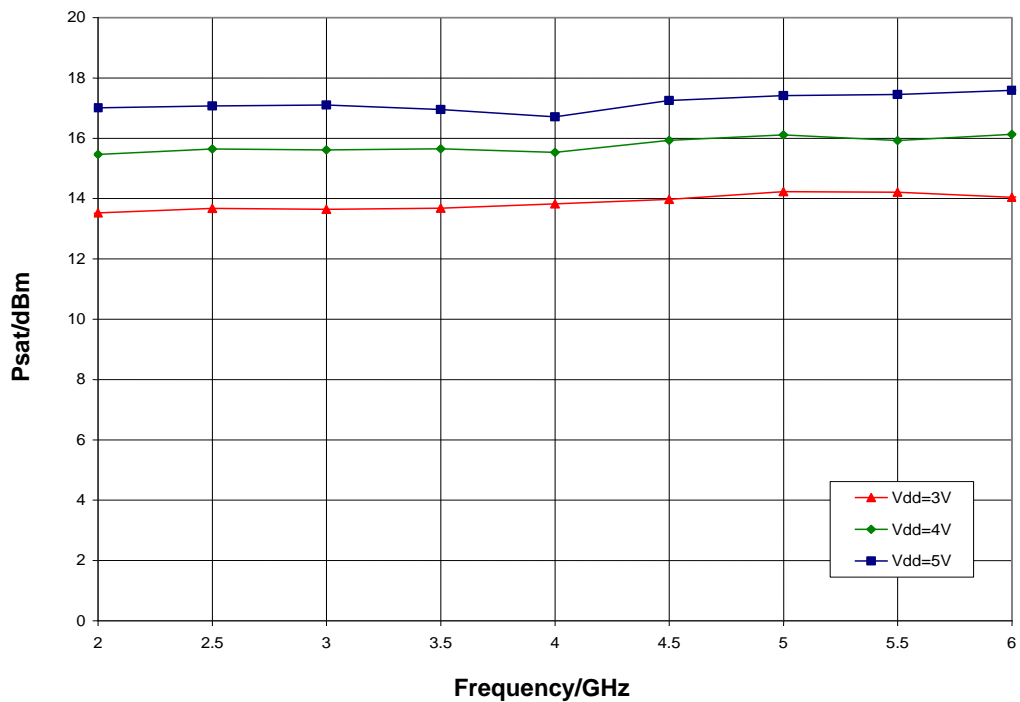

Typical Performance

Output IP3 vs. Temperature, $V_{dd} = 4.0\text{ V}$

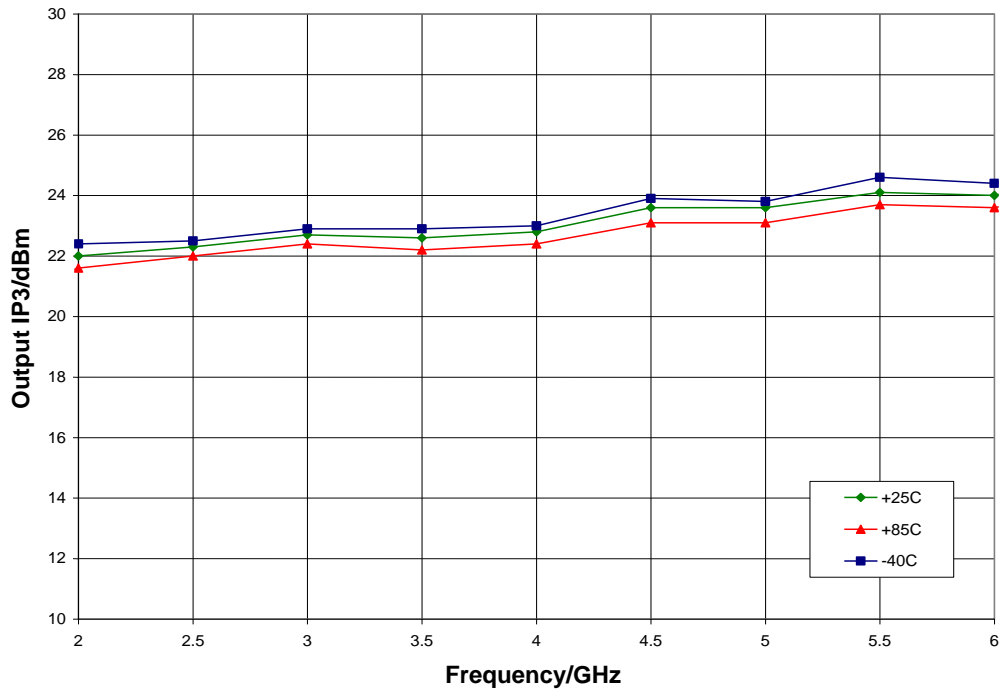

Output IP3 vs. V_{dd} , $T_A = 25^\circ\text{ C}$

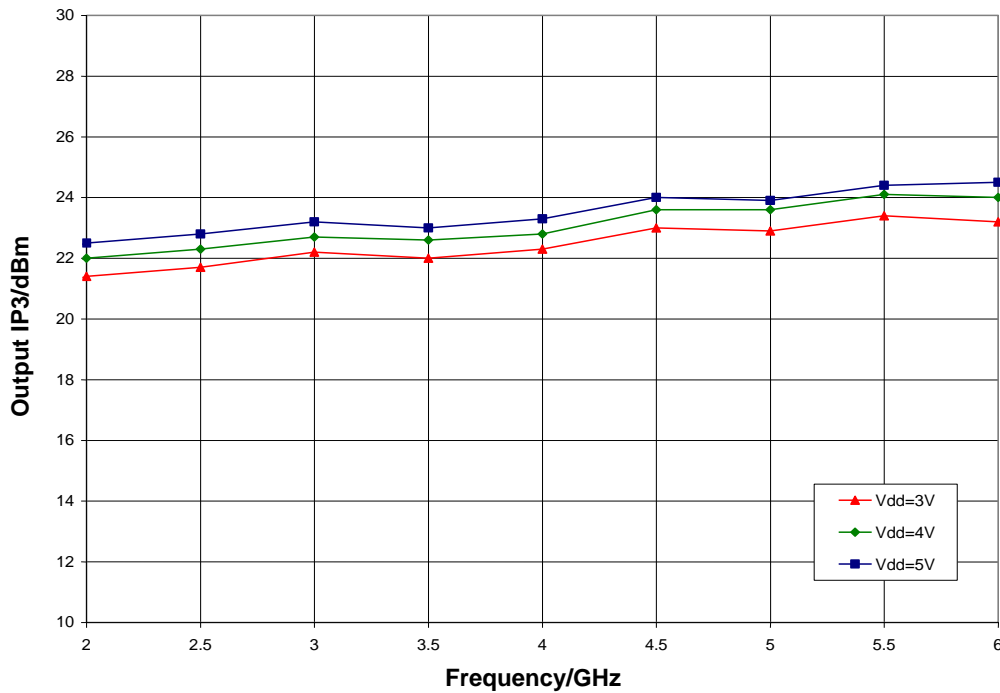

Mechanical Information

Package Information and Dimensions

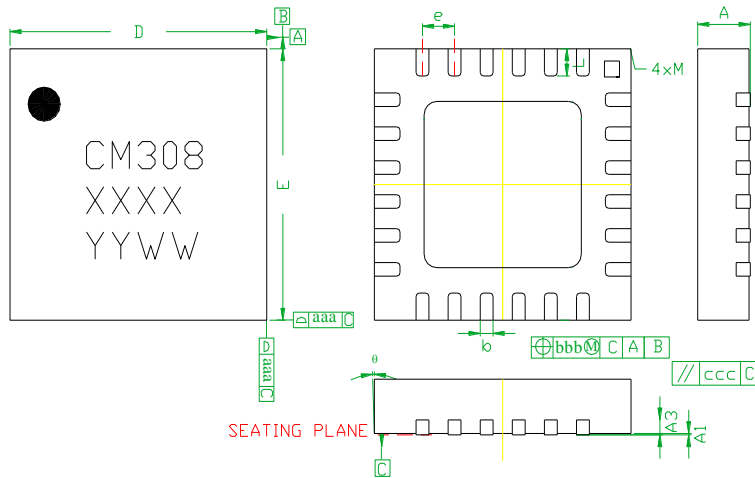

SYMBOLS	DIMENSIONS IN MILLIMETERS		
	MIN	NOM	MAX
A	0.80	0.90	1.00
A1	0	0.02	0.05
A3	---	0.25REF.	---
b	0.18	0.23	0.30
D	3.85	4.00	4.15
D1	---	2.45BSC	---
E	3.85	4.00	4.15
E1	---	2.45BSC	---
e	---	0.50BSC	---
L	0.30	0.40	0.50
θ	0	---	12
aaa	---	0.25	---
bbb	---	0.10	---
ccc	---	0.10	---
M	---	---	0.05

Notes:

1. Dimensions are in millimeters
2. RoHS compliant mold compound
3. Lead frame material: Copper alloy
4. Lead finish: 100% matte Sn
5. Indicated dimension/tolerance applies to leads and exposed pad

Recommended PCB Land Pattern

Qorvo recommends that the user develop the land pattern that will provide the best design for proper solder reflow and device attach for their specific application. Please review Qorvo Application Note AN 105 for a recommended land pattern approach.

Recommended Solder Reflow Profile

Qorvo recommends screen printing with belt furnace reflow to ensure proper solder reflow and device attach. Please review Qorvo Application Note AN 102 for a recommended solder reflow profile.

Pin Description

Pin Diagram

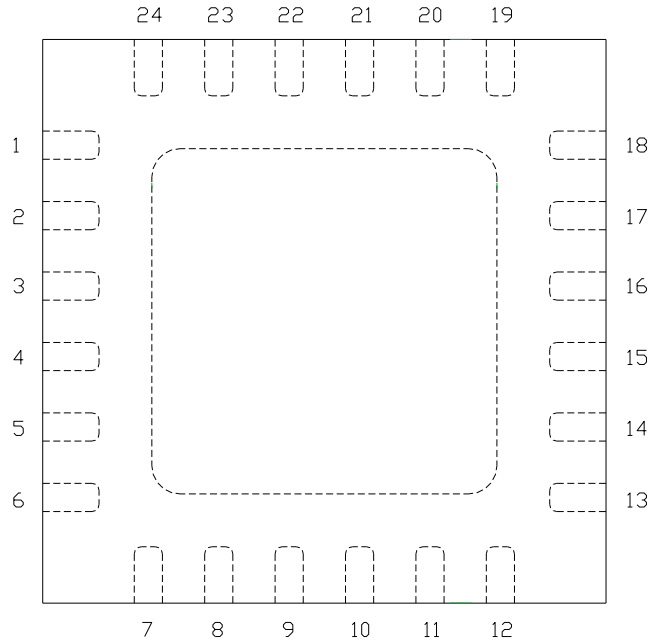

Functional Description

Pad	Function	Description	Schematic
1, 5 - 14, 18, 19, 21 - 24	N/C	No connection required These pins may be connected to RF/DC ground	
2, 4, 15, 17 and die paddle	Ground	Connect to RF / DC ground	
3	RF in	DC blocked and 50 ohm matched	
16	RF out	DC blocked and 50 ohm matched	
20	V _{dd}	Power supply voltage Decoupling and bypass caps required	

Applications Information

Application Circuit

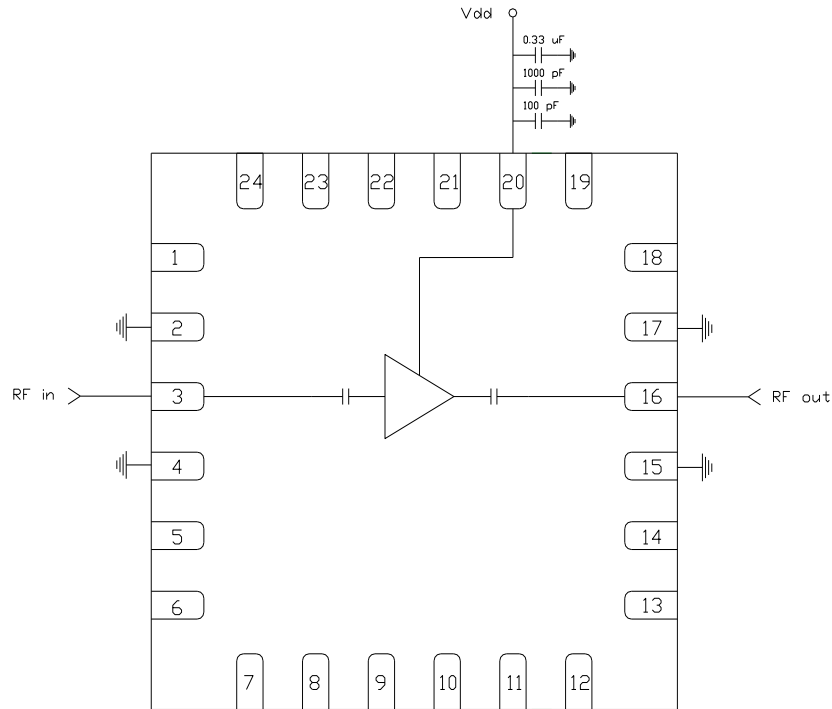

Biasing and Operation

The CMD308P4 is biased with a single positive drain supply.

Turn ON procedure:

1. Apply drain voltage V_{dd} and set to +4 V

Turn OFF procedure:

1. Turn off drain voltage V_{dd}

RF power can be applied at any time.

GaAs MMIC devices are susceptible to damage from Electrostatic Discharge. Proper precautions should be observed during handling, assembly and test.

Applications Information

Evaluation Board

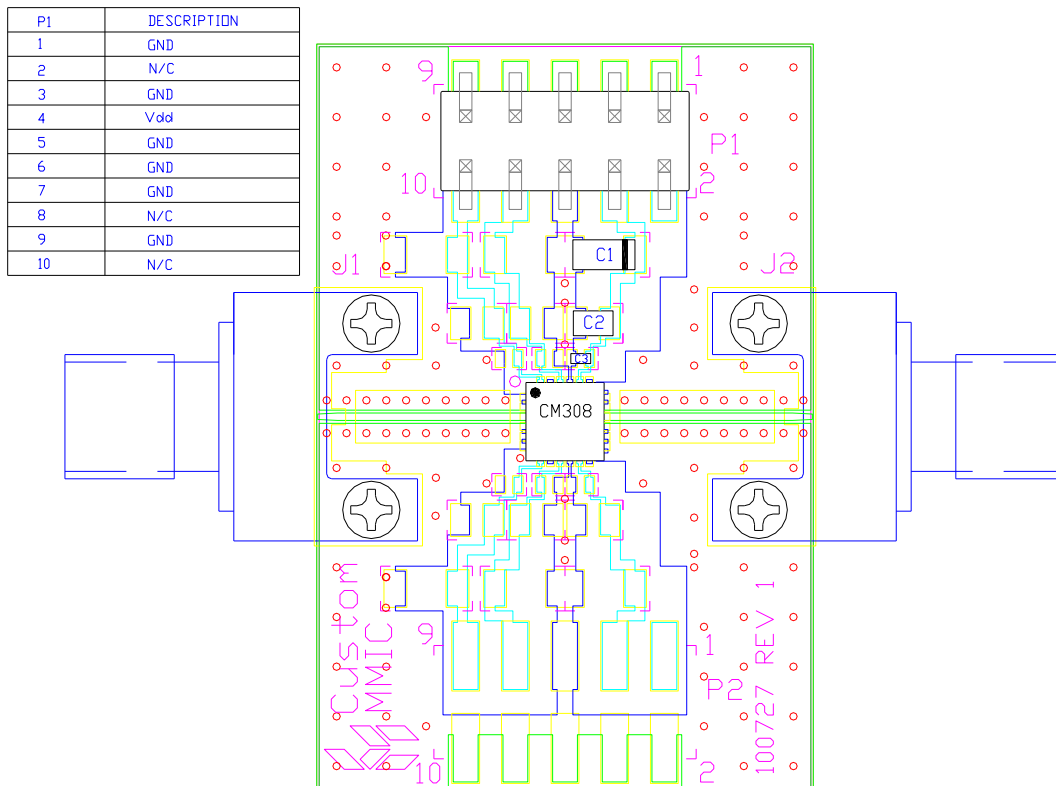

Bill of Material

Designator	Value	Description
J1, J2		SMA End Launch Connector
P1		10 Pin DC Header
C1	0.33 μ F	Capacitor, Tantalum
C2	1000 pF	Capacitor, 0603
C3	100 pF	Capacitor, 0402
U1		CMD308P4 Low Noise Amplifier
PCB		100727 Evaluation PCB