

Product Overview

The CMD316C3 is a broadband MMIC low noise amplifier housed in a leadless 3x3 mm surface mount package. The CMD316C3 is ideally suited for EW and communications systems where small size and low power consumption are needed. The broadband device delivers greater than 20 dB of gain with a corresponding output 1 dB compression point of +15 dBm and a noise figure of 2 dB. The CMD316C3 is a 50 ohm matched design eliminating the need for external DC blocks and RF port matching.

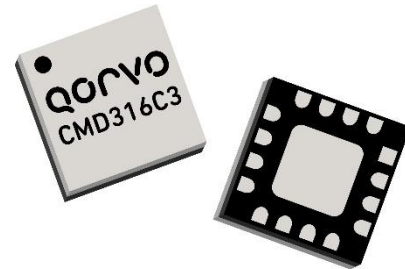

Functional Block Diagram

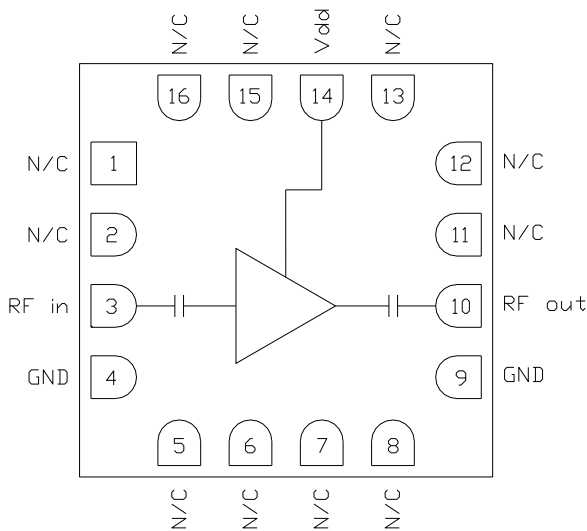

Key Features

- Low Noise Figure
- High Gain Broadband Performance
- Single Supply Voltage
- Pb-Free RoHs Compliant 3x3 QFN Package

Ordering Information

Part No.	Description
CMD316C3	6-20 GHz Low Noise Amplifier, 500 Piece 7" Reel
CMD316C3-EVB	Evaluation Board

Electrical Performance ($V_{dd} = 4.0\text{ V}$, $T_A = 25\text{ }^\circ\text{C}$, $F = 13\text{ GHz}$)

Parameter	Min	Typ	Max	Units
Frequency Range		6 - 20		GHz
Gain		21		dB
Noise Figure		2		dB
Input Return Loss		8		dB
Output Return Loss		12		dB
Output P1dB		15		dBm
Output IP3		25		dBm
Supply Current		100		mA

Absolute Maximum Ratings

Parameter	Rating
Drain Voltage, V_{dd}	5.5 V
RF Input Power	+20 dBm
Channel Temperature, T_{ch}	150 °C
Power Dissipation, P_{diss}	900 mW
Thermal Resistance, θ_{JC}	72.2 °C/W
Operating Temperature	-40 to 85 °C
Storage Temperature	-55 to 150 °C

Exceeding any one or combination of the maximum ratings may cause permanent damage to the device.

Recommended Operating Conditions

Parameter	Min	Typ	Max	Units
V_{dd}	3.0	4.0	5.0	V
I_{dd}		100		mA

Electrical performance is measured at specific test conditions. Electrical specifications are not guaranteed over all recommended operating conditions.

Drain Current vs. Drain Voltage

V_{dd} (V)	I_{dd} (mA)
3.0	92
4.0	100
5.0	112

Electrical Specifications ($V_{dd} = 4.0$ V, $T_A = 25$ °C)

Parameter	Min	Typ	Max	Min	Typ	Max	Units
Frequency Range	6 - 18			18 - 20			GHz
Gain	17.5	21		15	19		dB
Noise Figure		2	2.75		2.4	3	dB
Input Return Loss		10			15		dB
Output Return Loss		13			20		dB
Output P1dB		15.5			15.5		dBm
Output IP3		25.5			25		dBm
Supply Current	70	100	130	70	100	130	mA
Gain Temperature Coefficient		0.017			0.025		dB/°C
Noise Figure Temperature Coefficient		0.008			0.01		dB/°C

Typical Performance

Broadband Performance, $V_{dd} = 4.0\text{ V}$, $T_A = 25\text{ }^\circ\text{C}$

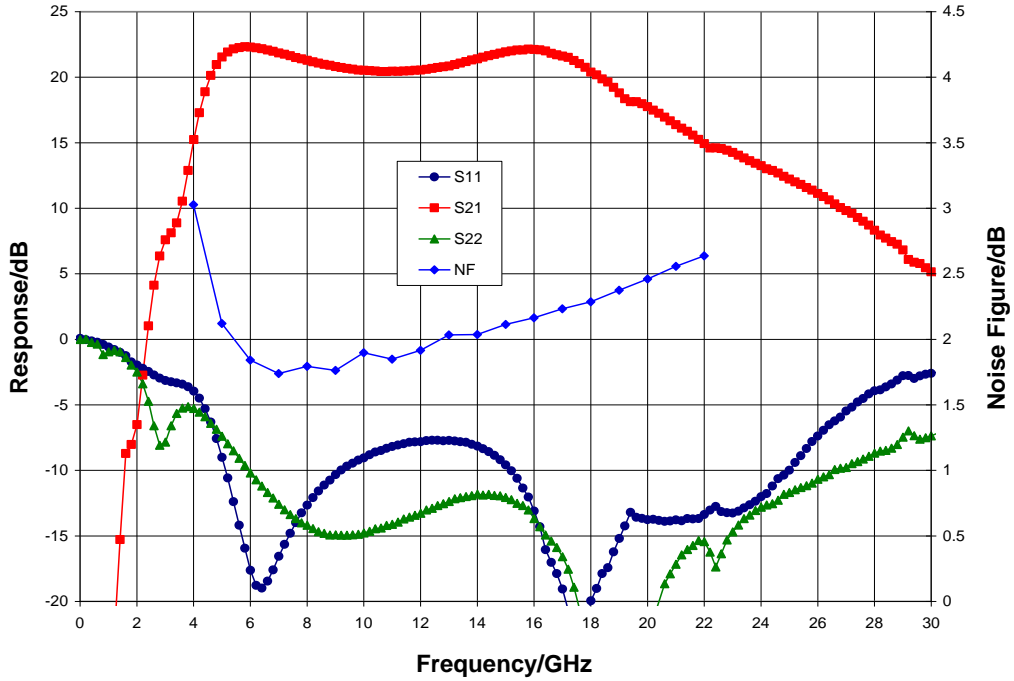

Narrow-band Performance, $V_{dd} = 4.0\text{ V}$, $T_A = 25\text{ }^\circ\text{C}$

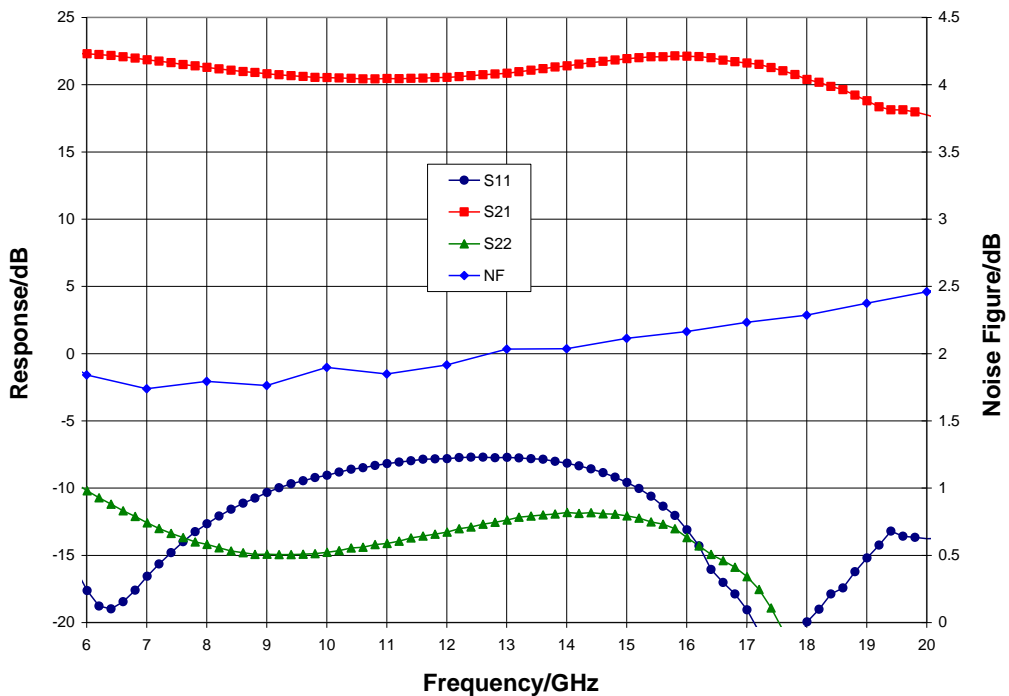

Typical Performance

Gain vs. Temperature, $V_{dd} = 4.0\text{ V}$

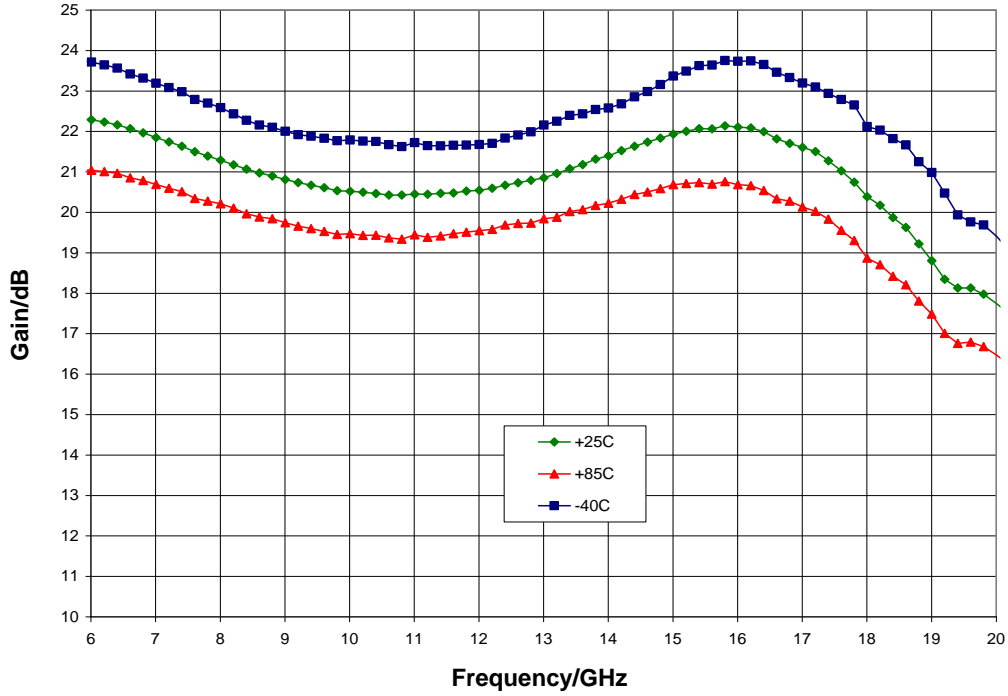

Gain vs. V_{dd} , $T_A = 25\text{ °C}$

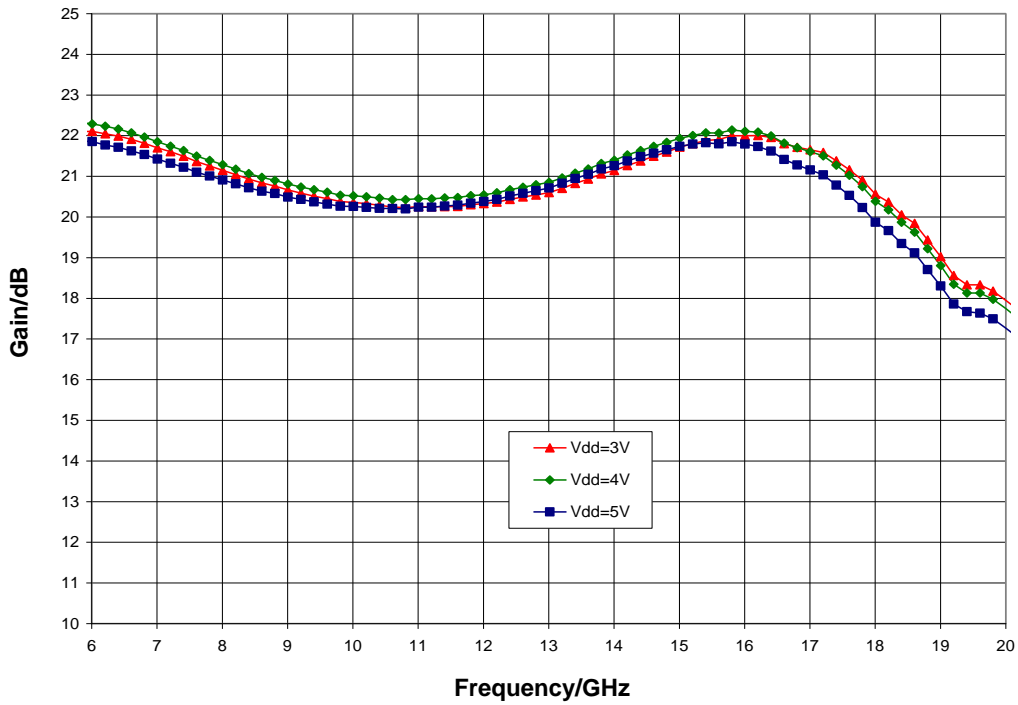

Typical Performance

Noise Figure vs. Temperature, $V_{dd} = 4.0\text{ V}$

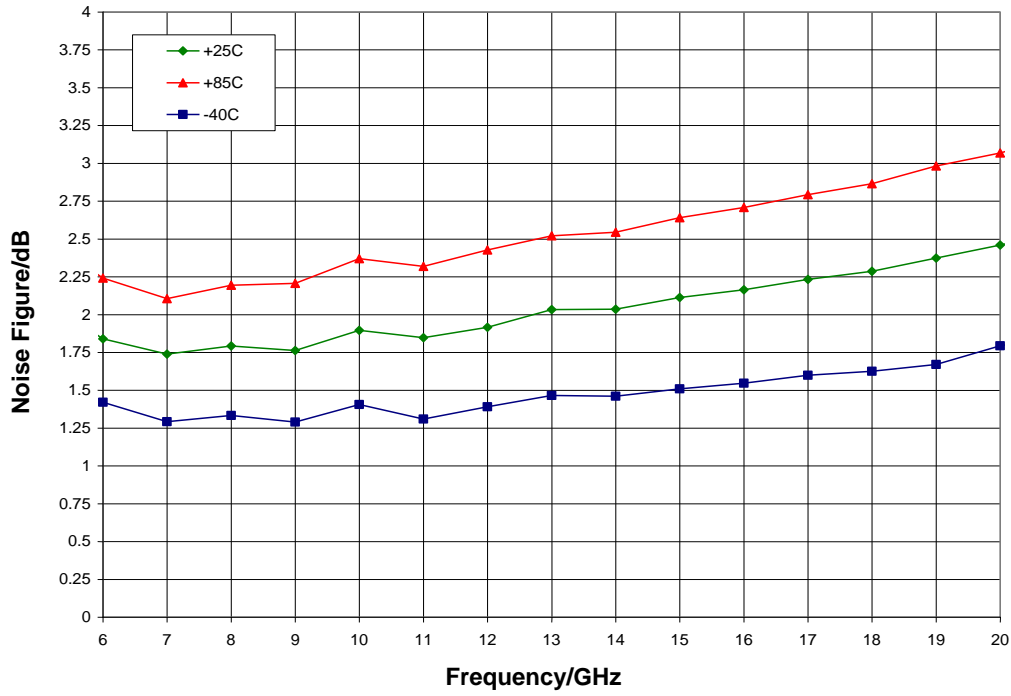

Noise Figure vs. V_{dd} , $T_A = 25\text{ }^\circ\text{C}$

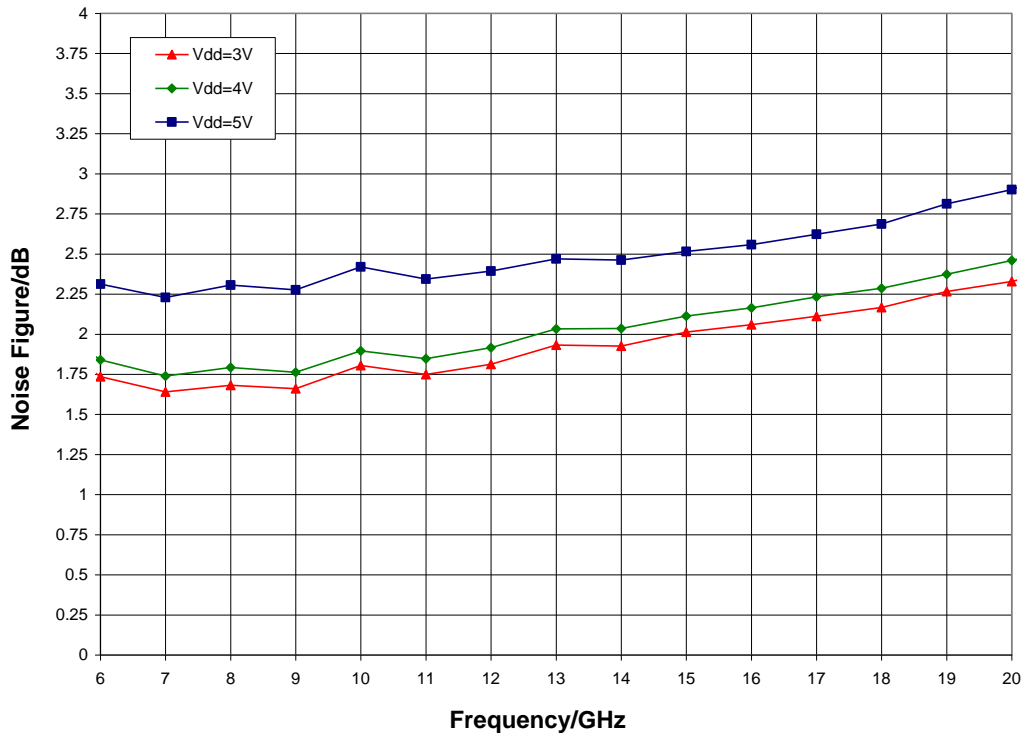

Typical Performance

P1dB vs. Temperature, $V_{dd} = 4.0\text{ V}$

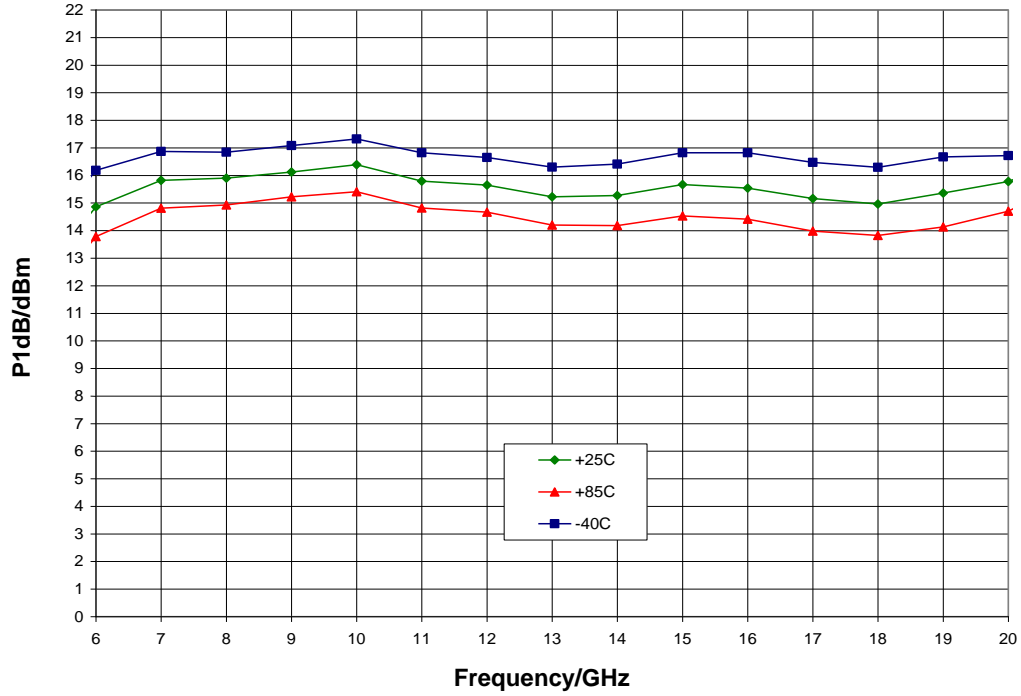

P1dB vs. V_{dd} , $T_A = 25\text{ °C}$

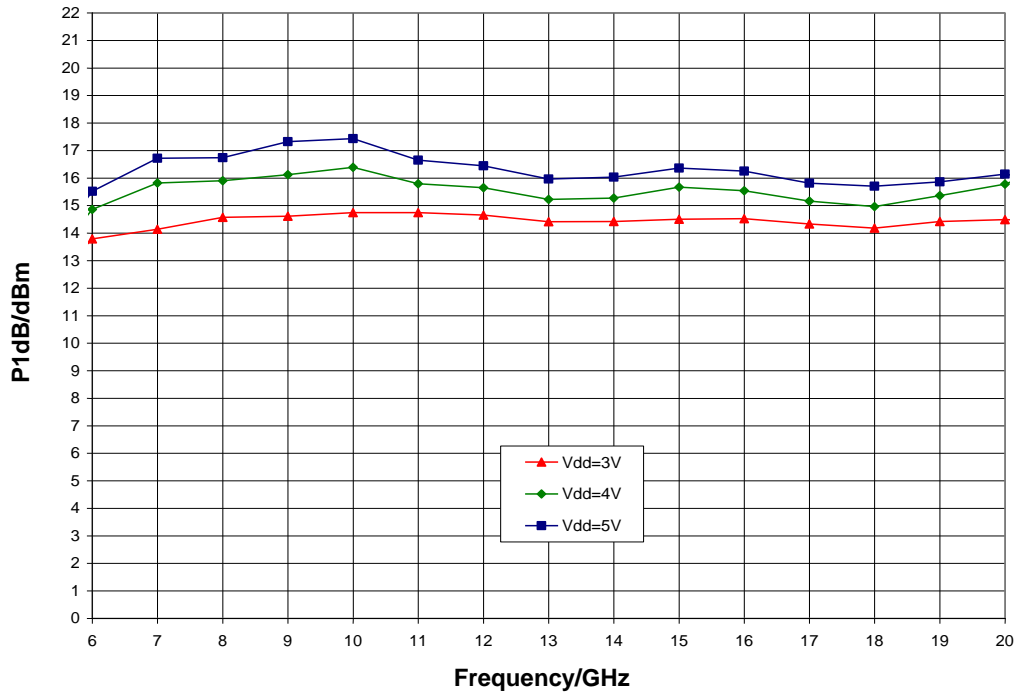

Typical Performance

Psat vs. Temperature, $V_{dd} = 4.0\text{ V}$

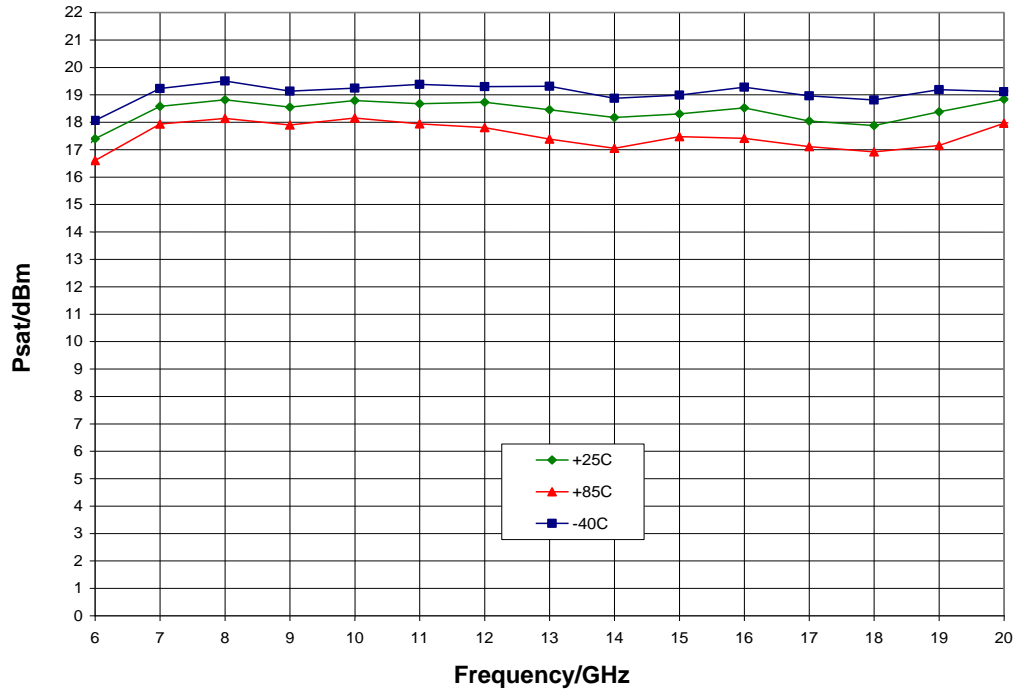

Psat vs. V_{dd} , $T_A = 25\text{ °C}$

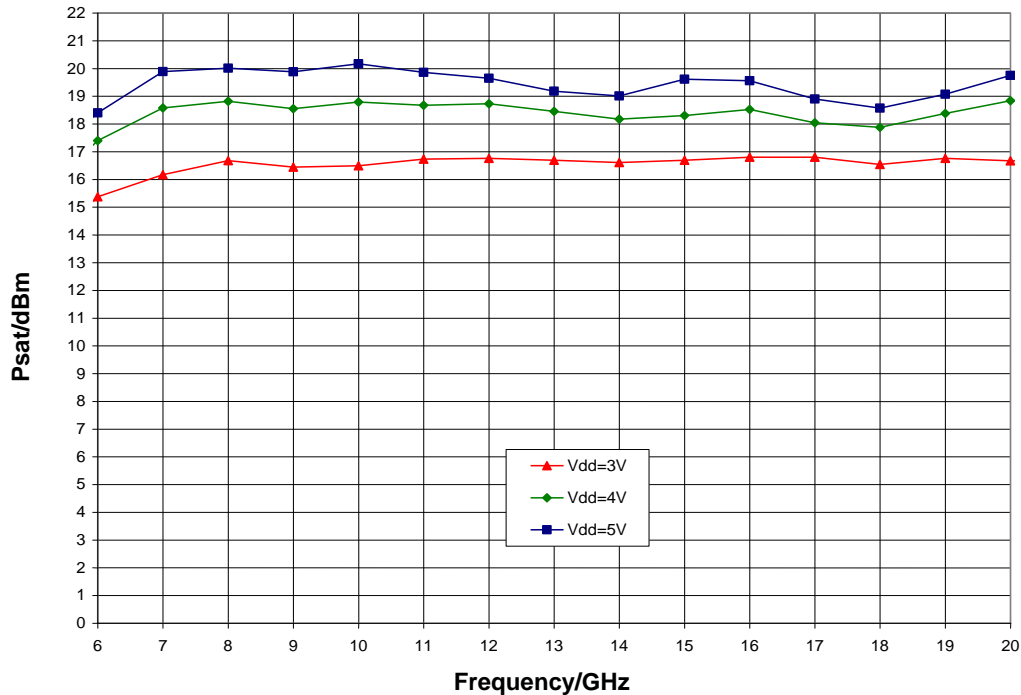

Typical Performance

Output IP3 vs. Temperature, $V_{dd} = 4.0\text{ V}$

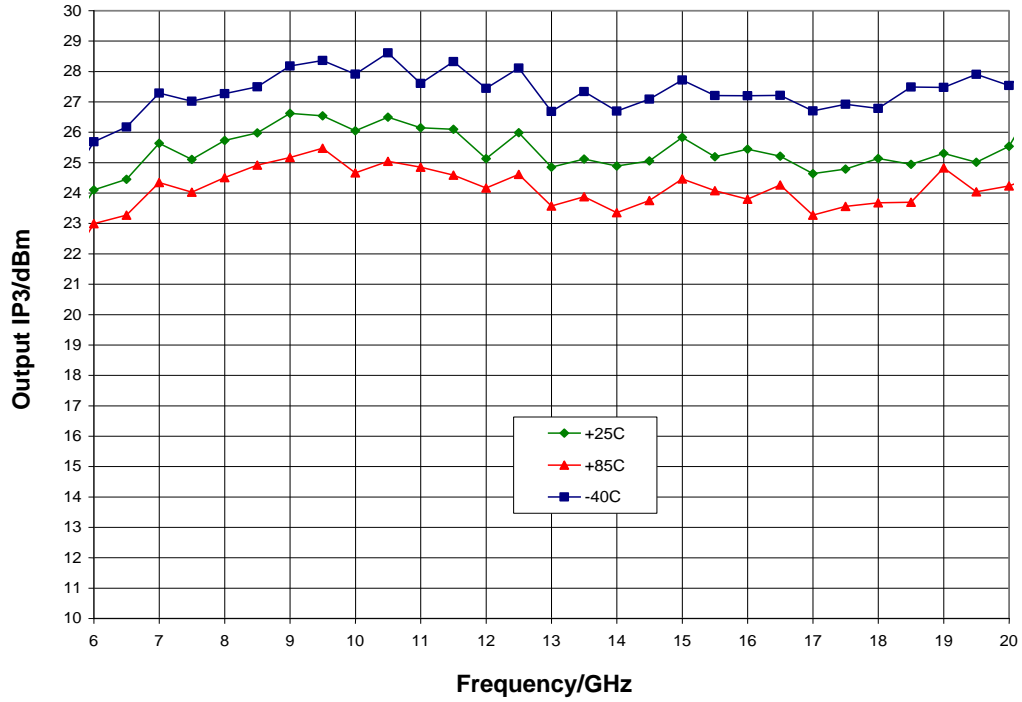

Output IP3 vs. V_{dd} , $T_A = 25\text{ °C}$

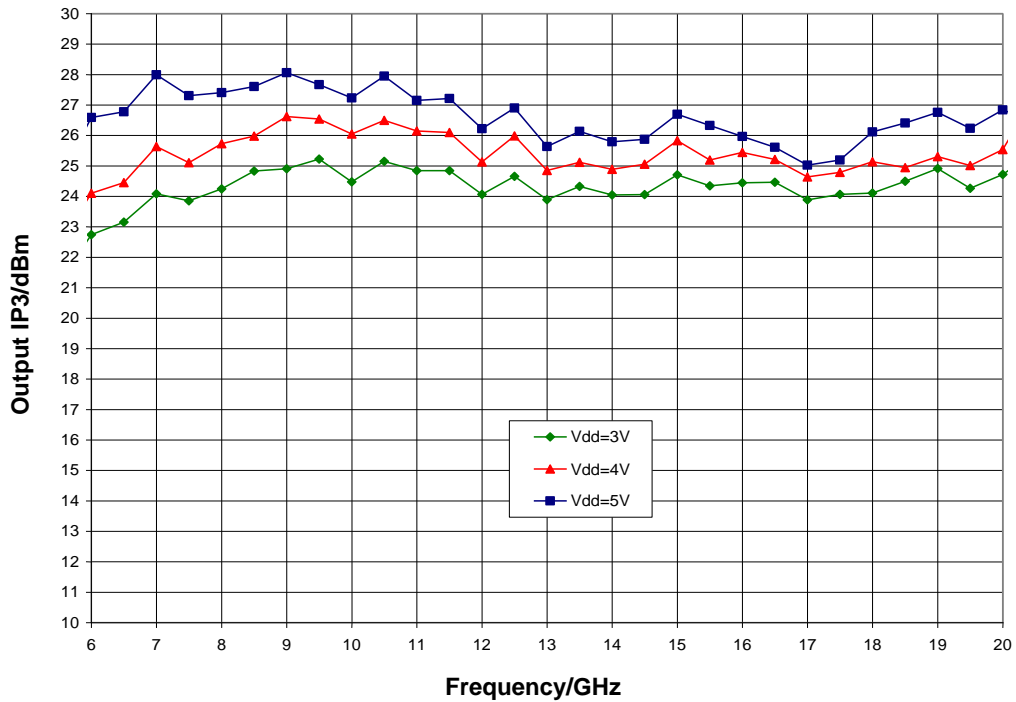

Mechanical Information

Package Information and Dimensions

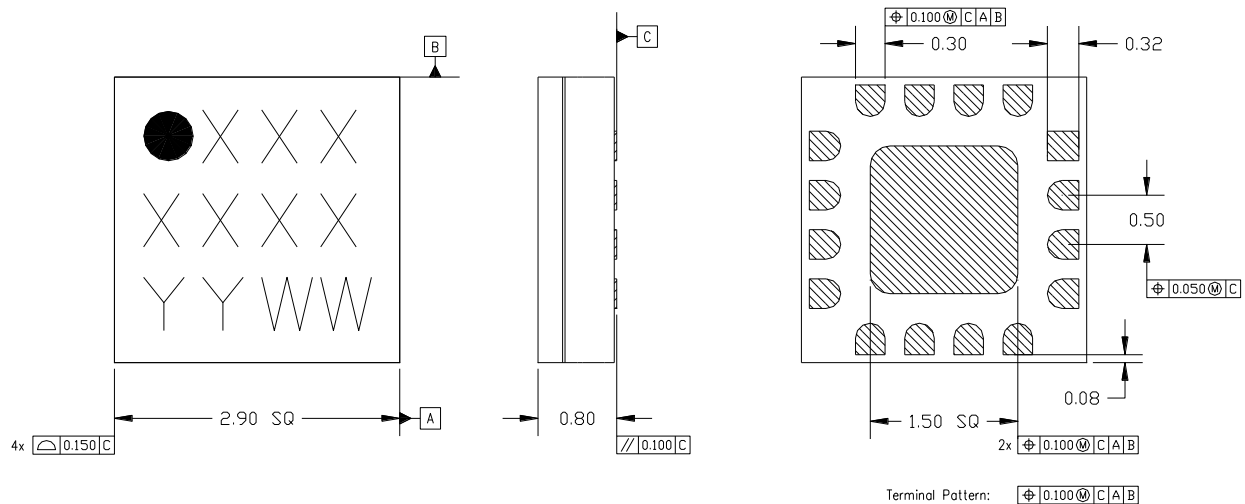

Notes:

1. All dimensions shown in mm.
2. Material: Black alumina
3. Lead finish
 - 3.1. Ni: 8.89um max, 1.27um min
 - 3.2. Pd: 0.17um max, 0.07um min
 - 3.3. Au: 0.254um max, 0.03um min
4. Marking
 - 4.1. Line 1: Part number
 - 4.1.1. Example: CMD316C3 shall be marked as 316
 - 4.2. Line 2: Lot number
 - 4.3. Line 3: Date code - Last 2 digits of the year of manufacture followed by a 2 digit week code
5. Alternate pin #1 identifier is a single square pad
6. Alternate die paddle may have chamfered corners

Recommended PCB Land Pattern

Qorvo recommends that the user develop the land pattern that will provide the best design for proper solder reflow and device attach for their specific application. Please review Qorvo Application Note AN 105 for a recommended land pattern approach.

Recommended Solder Reflow Profile

Qorvo recommends screen printing with belt furnace reflow to ensure proper solder reflow and device attach. Please review Qorvo Application Note AN 102 for a recommended solder reflow profile.

Pin Description

Pin Diagram

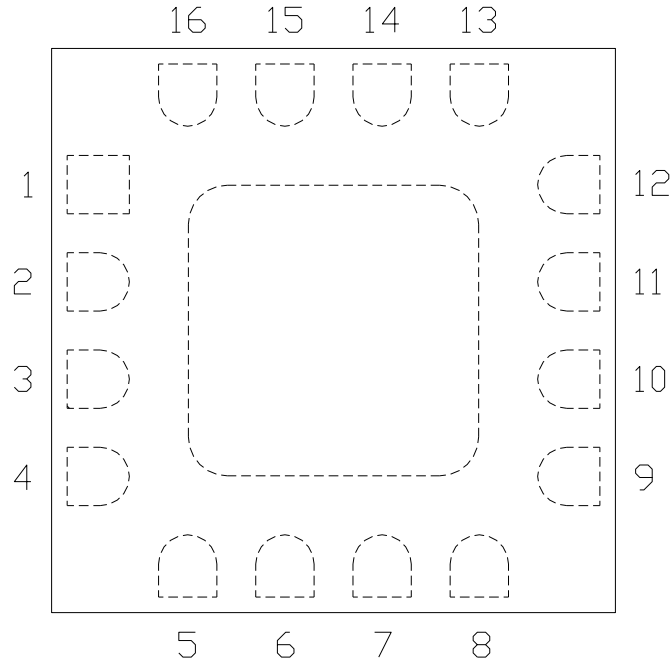

Functional Description

Pin	Function	Description	Schematic
1, 2, 5 - 8, 11 - 13, 15, 16	N/C	No connection required These pins may be connected to RF / DC ground	
3	RF in	DC blocked and 50 ohm matched	
10	RF out	DC blocked and 50 ohm matched	
14	V _{dd}	Power supply voltage Decoupling and bypass caps required	
4, 9 and die paddle	Ground	Connect to RF / DC ground	

Applications Information

Application Circuit

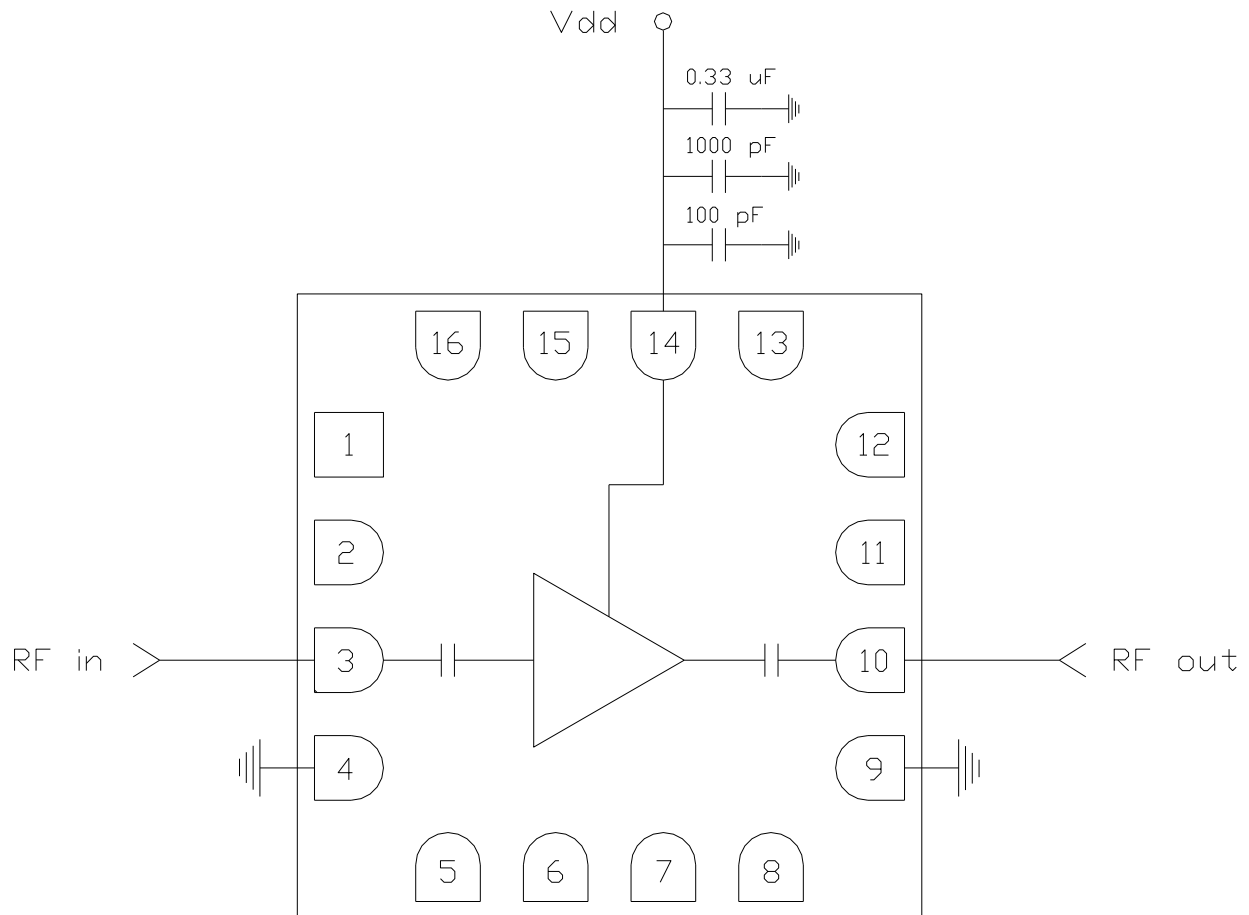

Biasing and Operation

The CMD316C3 is biased with a single 4.0 V positive drain supply.

RF power can be applied at any time.

GaAs MMIC devices are susceptible to damage from Electrostatic Discharge. Proper precautions should be observed during handling, assembly and test.

Applications Information

Evaluation Board

The circuit board shown has been developed for optimized assembly at Qorvo. A sufficient number of via holes should be used to connect the top and bottom ground planes. As surface mount processes vary, careful process development is recommended.

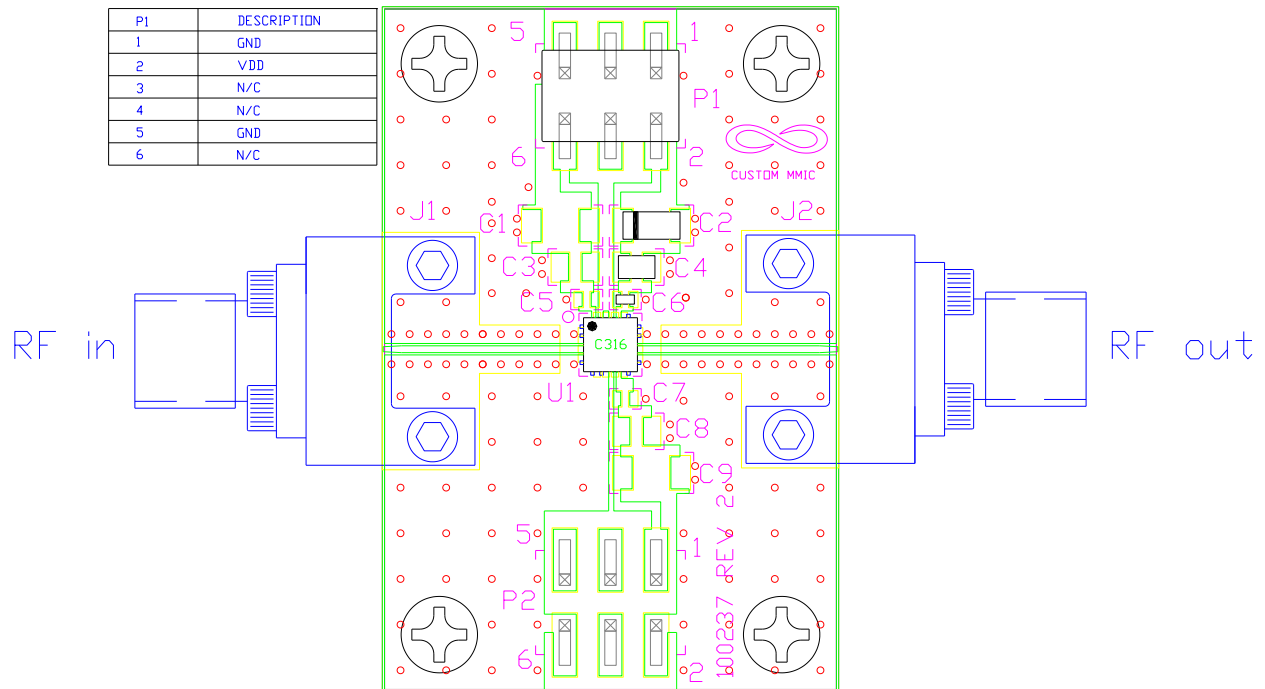

Bill of Material

Designator	Value	Description
J1, J2		SMA End Launch Connector
P1		6 Pin Header
C2	0.33 μ F	Capacitor, Tantalum
C4	1000 pF	Capacitor, 0603
C6	100 pF	Capacitor, 0402
U1		CMD316C3 Low Noise Amplifier
PCB		100237 Evaluation PCB