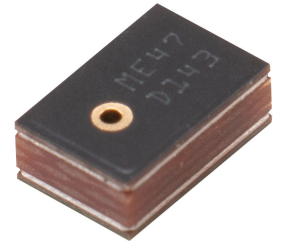

MODEL: CMM-2718AT-38164W-TR | **DESCRIPTION:** MEMS MICROPHONE

FEATURES

- top port
- analog
- omnidirectional
- frequency response range (20 Hz-20 kHz)

ELECTRICAL

parameter	conditions/description	min	typ	max	units
directivity	omnidirectional				
sensitivity [S]	at 1 V/Pa, 1 kHz	-39	-38	-37	dB
supply voltage [V _{DD}]		1.5		3.6	V
current consumption [I _{loss}]			175		µA
sensitivity reduction	no change across the voltage range				dB
frequency [f]		20		20,000	Hz
signal to noise ratio [S/N]	20 kHz bandwidth, A-weighted		64		dB
total harmonic distortion [THD]	at 94 dB SPL, 1 kHz, R _{load} > 2 k		0.1		%
acoustic overload point [AOP]	at 10% THD, 1 kHz, R _{load} > 2 k		128		dB SPL
output impedance [Z _{out}]	at 1 kHz		170		Ω
dc output			0.75		V
PSRR	200 mVp-p sine wave @ 1 kHz, V _{DD} = 1.8 V		65		dB
PSR	100 mVp-p square wave @ 217 Hz, V _{DD} = 1.8 V		-90		dBV[A]

Notes: 1. All specifications measured at 1.8 V, 25±10°C, humidity at 50±20%, unless otherwise noted.

ENVIRONMENTAL

parameter	conditions/description	min	typ	max	units
operating temperature		-20		70	°C
storage temperature	in packaging	-40		100	°C
RoHS	yes				

MECHANICAL

parameter	conditions/description	min	typ	max	units
dimensions	2.75 x 1.85 x 1.0				mm
acoustic port	top				
terminals	surface mount				
weight			0.03		g

MECHANICAL DRAWING

units: mm
 tolerance:
 length, width, height: ± 0.10 mm
 acoustic port: ± 0.05 mm
 unless otherwise specified: ± 0.15 mm

TERMINAL CONNECTIONS	
TERM.	FUNCTION
1	V _{DD}
2	output
3	GND
4	GND

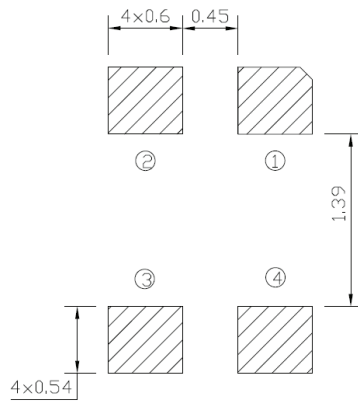
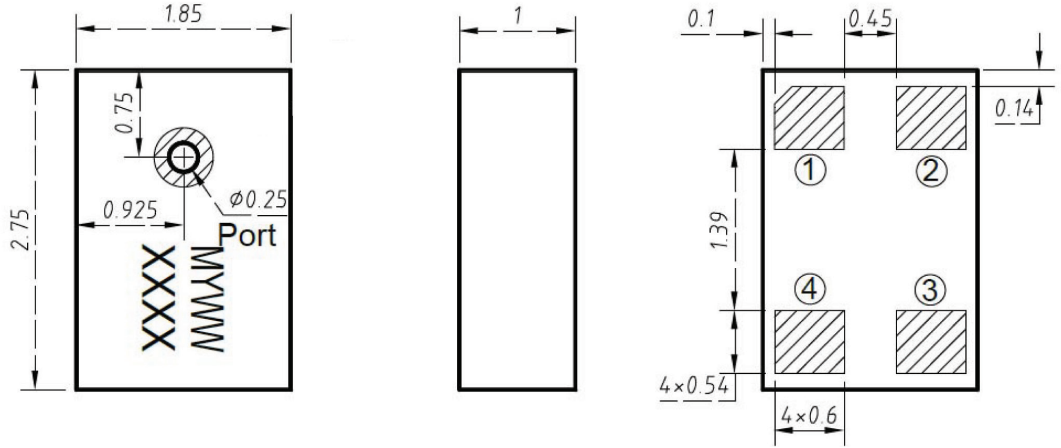

Recommended PCB Layout
Top View

INTERFACE CIRCUIT

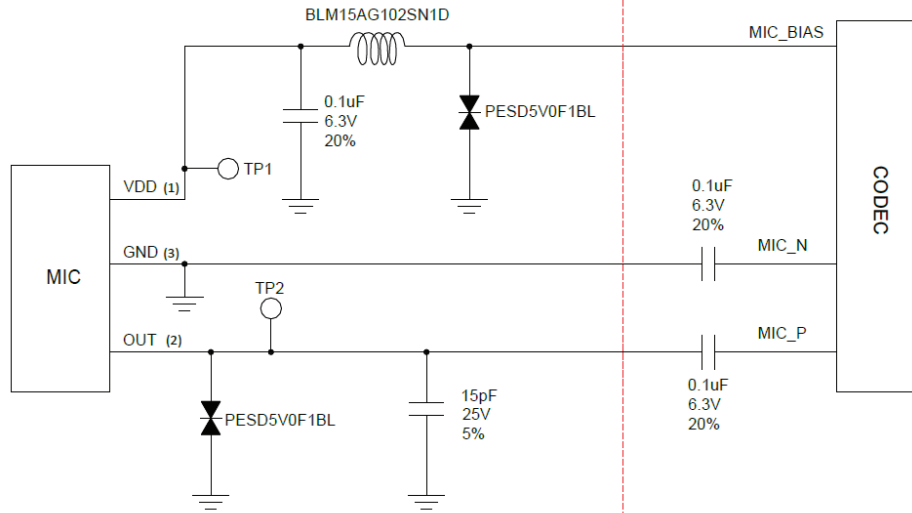

Note: 2. It is recommended that the components on the left side of red line be placed close to MIC, and components on the right side of red line be placed close to CODEC.

FREQUENCY RESPONSE CURVE

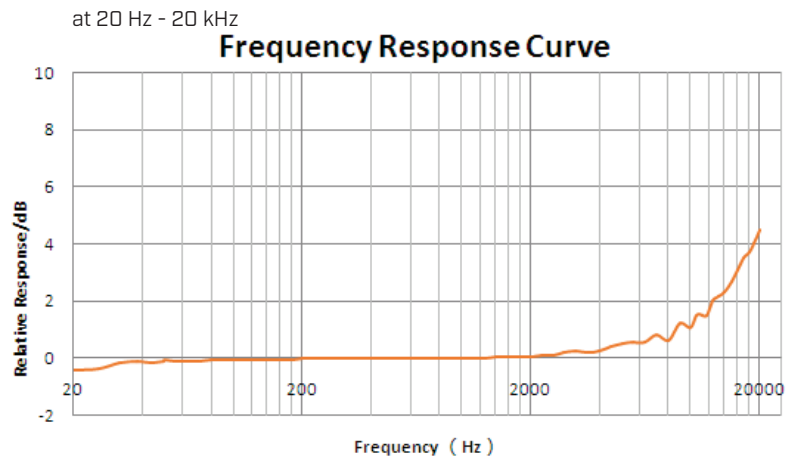
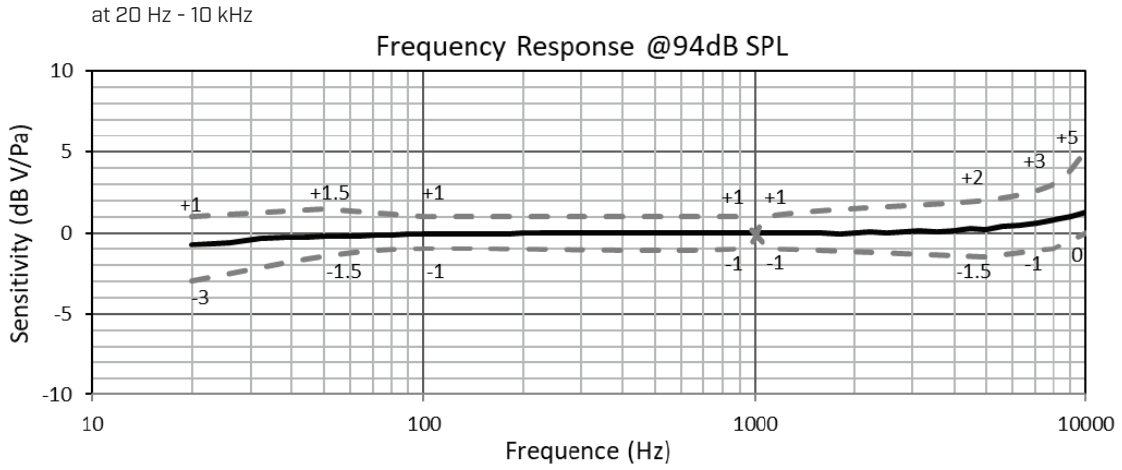

PHASE

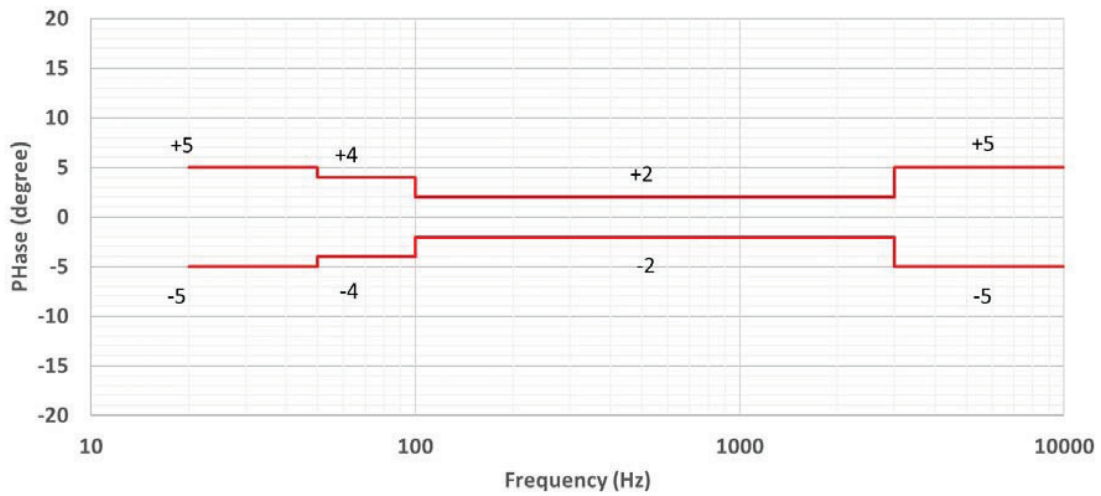

	20-50 Hz	50-100 Hz	100 Hz-3 kHz	3-10 kHz
Max	+5°	+4°	+2°	+5°
Min	-5°	-4°	-2°	-5°

SOLDERABILITY

parameter	conditions/description	min	typ	max	units
reflow soldering ³	see reflow profile			260	°C

Note: 3. Not recommended to exceed 3 reflow cycles.

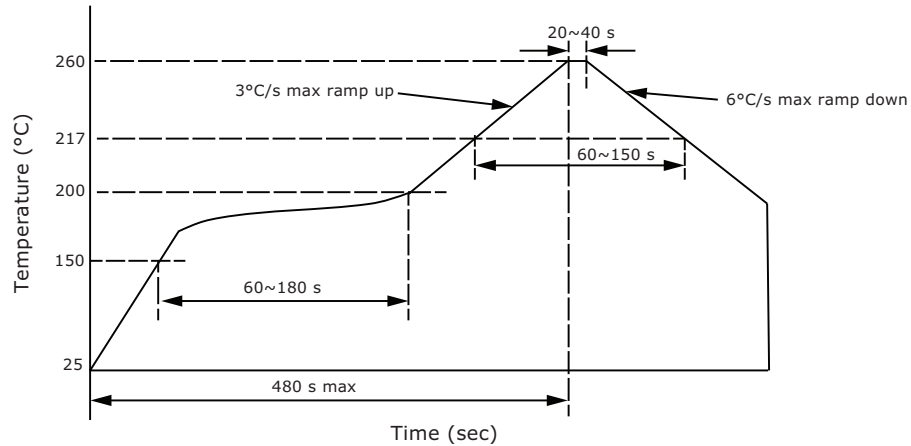

HANDLING RECOMMENDATIONS

1. Not recommended to blow air heavily over acoustic port as debris could impact mic function.
2. Not suitable for wash process after reflow.
3. Not recommended to brush board with or without solvents after reflow process.
4. Not recommended to directly expose to ultrasonic processing or cleaning.
5. Not recommended to insert any object in port of device at any time.
6. Not recommended to apply over 30 psi of air pressure into the port hole.
7. Not recommended to pull a vacuum over port hole.
8. Not recommended to apply a vacuum when repackaging into sealed bag a rate faster than 0.5 atm/sec.
9. Not recommended to clean table or carried plate with air guarding system that could induce particle floating inside mic.

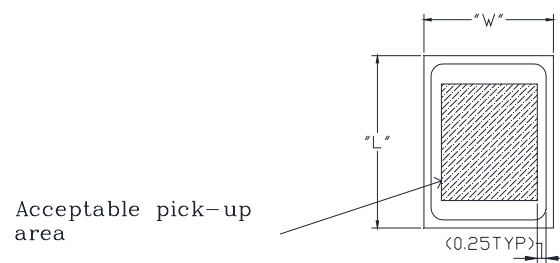

Recommended Vacuum Nozzle Pickup
Top View

PACKAGING

parameter	conditions/description	min	typ	max	units
MSL	Class 1				
reel size	Ø7 inches				
reel QTY ⁴	1,100 pcs per reel				
carton size	310 x 210 x 165 mm				
carton QTY	5,500 pcs				

Note: 4. The leader tape of the reel, and the beginning tape fixed into the reel center, will leave 25 blank cavities each.

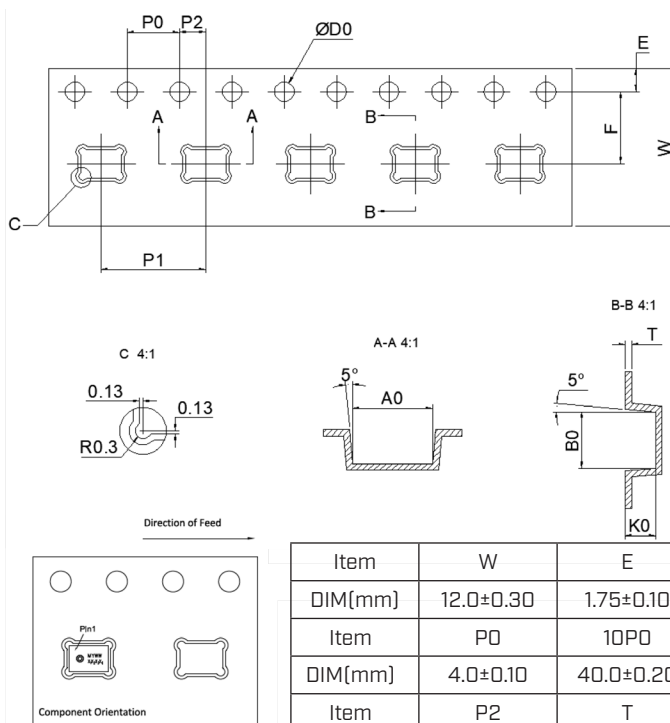

Item	W	E	F	ØD0	K0
DIM(mm)	12.0±0.30	1.75±0.10	5.50±0.10	1.50+0.10/-0	1.15±0.10
Item	P0	10P0	P1	A0	B0
DIM(mm)	4.0±0.10	40.0±0.20	8.0±0.10	3.05±0.10	2.15±0.10
Item	P2	T	--	--	--
DIM(mm)	2.0±0.10	0.25±0.05	--	--	--

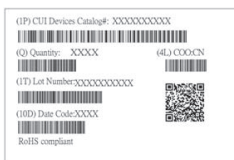

貼于圓盤,靜電袋,內盒上

Lot No.	XXXXXXXXXX
Part No.	CUI Inv#. CUI Part#.
Quantity.	XXXX Pcs
Date:	DD MM YY
MADE IN CHINA	
CUI DEVICES	

RoHS Compliant

