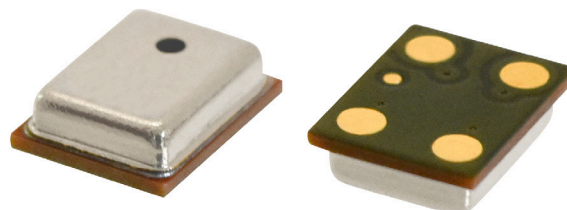

MODEL: CMM-3729AT-42316-TR | **DESCRIPTION:** MEMS MICROPHONE**FEATURES**

- analog
- small package
- reflow solder compatible
- omnidirectional

**ELECTRICAL**

parameter	conditions/description	min	typ	max	units
directivity	omnidirectional				
sensitivity (S)	at 94 dB SPL, 1 kHz	-45	-42	-39	dB
supply voltage (V _{DD})		1.6	2.0	3.6	V
current consumption (I _{DSS})	V _{DD} = 2.0 V		160		μA
sensitivity reduction	V _{DD} = 3.6 ~ 1.6 V		-0.5		dB
frequency (f)		100		10,000	Hz
signal to noise ratio (S/N)	at 94 dB SPL, 1 kHz (A-weighted)		57		dBA
total harmonic distortion (THD)	at 94 dB SPL, 1 kHz		0.2		%
acoustic overload point (AOP)	at 10% THD, 1 kHz		125		dB SPL
output impedance (Z _{out})	at 1 kHz			300	Ω

Notes: 1. All specifications measured at 23±2°C, humidity at 55±20%, unless otherwise noted.

ENVIRONMENTAL

parameter	conditions/description	min	typ	max	units
operating temperature		-40		105	°C
storage temperature	in packaging	-40		85	°C
RoHS	yes				

MECHANICAL

parameter	conditions/description	min	typ	max	units
dimensions	3.76 x 2.95 x 1.10				mm
acoustic port	top				
terminals	surface mount				
weight			0.024		g

MECHANICAL DRAWING

units: mm
tolerance: ± 0.1 mm

TERMINAL CONNECTIONS	
TERM.	FUNCTION
1	V _{DD}
2	GND
3	GND
4	output

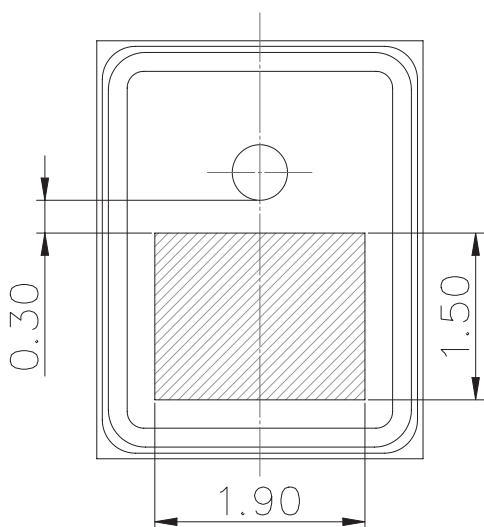
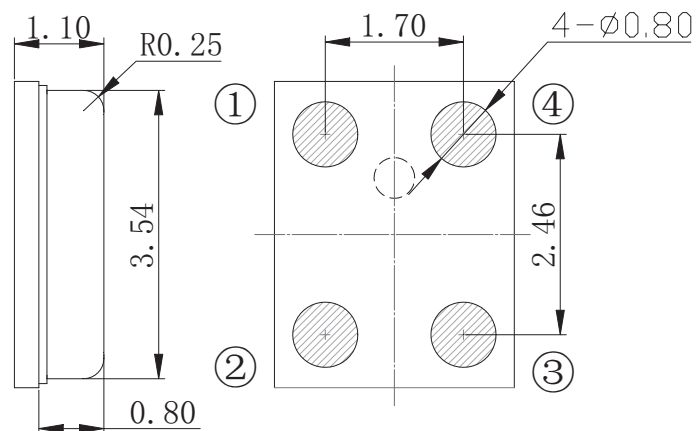
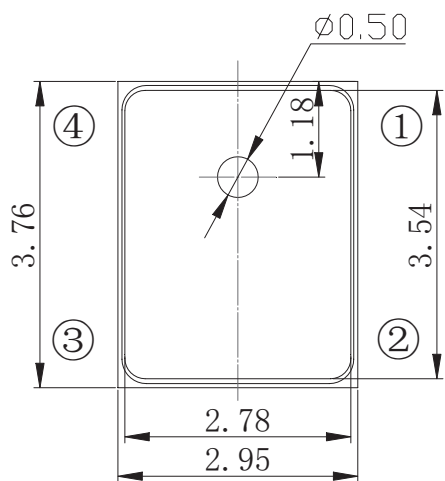

Recommended Vacuum Nozzle Pickup
Top View

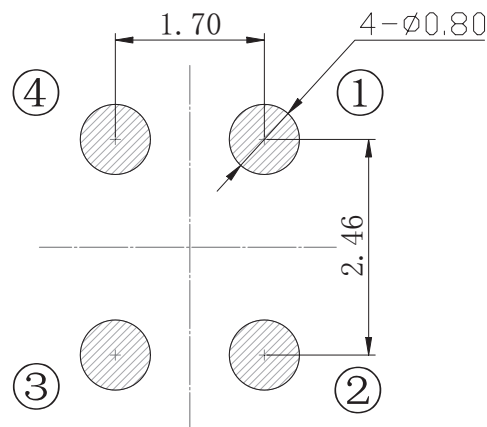

Recommended PCB Layout
Top View

FREQUENCY RESPONSE CURVE

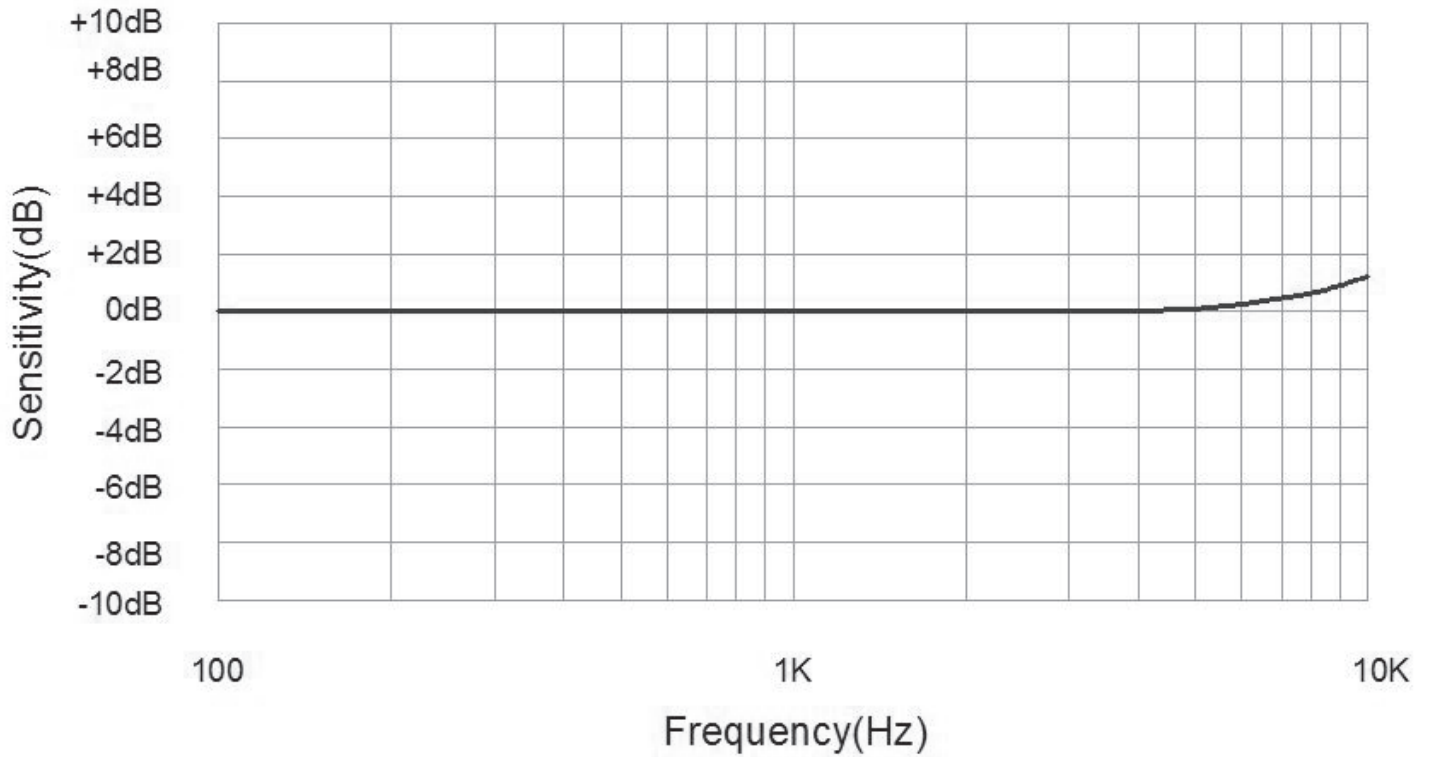

APPLICATION CIRCUIT

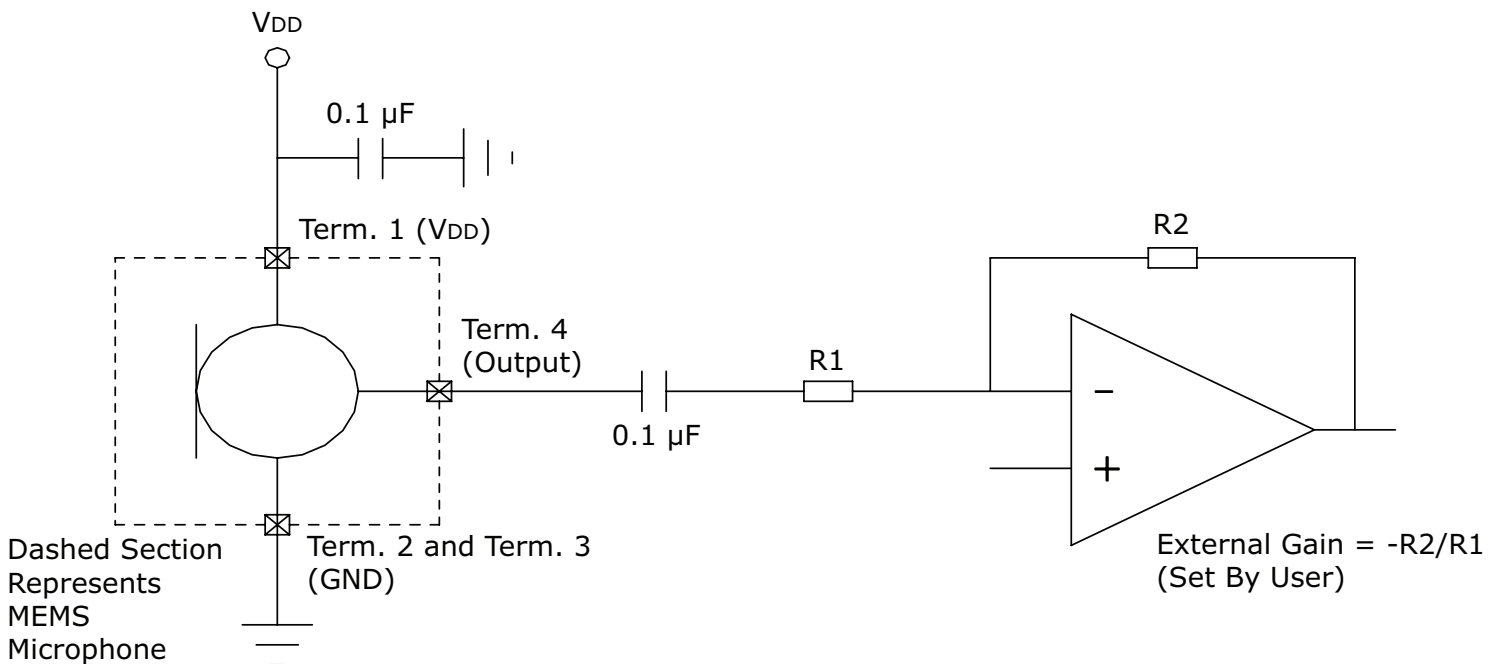

SOLDERABILITY

parameter	conditions/description	min	typ	max	units
reflow soldering	see reflow profile			260	°C

- Note:
1. Vacuuming over acoustical hole is not allowed.
 2. Not suitable for wash process.
 3. Not recommended to exceed 5 reflow cycles.



PACKAGING

parameter	conditions/description	min	typ	max	units
reel storage ⁴	at relative humidity <75%	-40		85	°C
MSL	Class 1				
reel size	Ø170 mm max				
reel QTY	1,000 pcs per reel				

- Note: 4. Recommended storage period no more than 1 year. Floor life (out of bag) no more than 4 weeks.

