

CMPA1C1D080F

90 W, 12.75 - 13.25 GHz, GaN MMIC, Power Amplifier

Description

Cree's CMPA1C1D080F is a packaged, 90 W HPA utilizing Cree's high performance, 0.25um GaN on SiC production process. With a 12.75 - 13.25 GHz operating frequency range targeting satellite communications, the CMPA1C1D080F offers 3rd-order intermodulation performance of -30 dBc at 20 W of total output power. For exceptional thermal management, the HPA is offered in a bolt-down, flange package.



PN: CMPA1C1D080F
Package Type: 440222

Typical Performance Over 12.75 - 13.25 GHz ($T_c = 25^\circ\text{C}$)

Parameter	12.75 GHz	13.0 GHz	13.25 GHz	Units
Small Signal Gain ^{1,2}	26.6	25.3	25.2	dB
Output Power ^{1,3}	49.7	49.9	49.7	dBm
Power Gain ^{1,3}	16.7	16.9	16.7	dB
Power Added Efficiency ^{1,3}	23	23	21	%
IM3 ^{1,4}	-27	-27	-27	dBc

Notes:

¹ $V_{DD} = 40\text{ V}$, $I_{DQ} = 750\text{ mA}$

² Measured at Pin = -15 dBm

³ Measured at Pin = 33 dBm, CW

⁴ Measured at 40 dBm Pout/tone, 10 MHz

Features

- 90 W Typical P_{SAT}
- >21% Typical Power Added Efficiency
- 25 dB Small Signal Gain
- 20 W Total Output Power at -30 dBc IM3
- Operation up to 40 V

Note: Features are typical performance across frequency under 25°C operation. Please reference performance charts for additional details.

Applications

- Satellite Communications Uplink

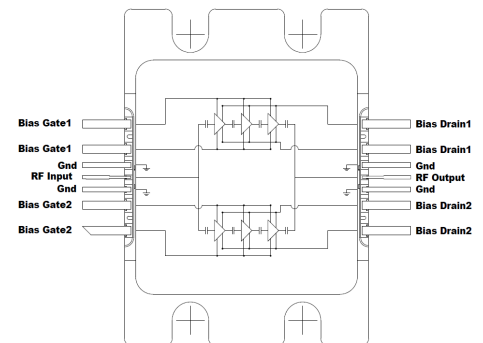

Figure 1.



Absolute Maximum Ratings (not simultaneous) at 25 °C

Parameter	Symbol	Rating	Units	Conditions
Drain-source Voltage	V_{DSS}	120	VDC	25°C
Gate-source Voltage	V_{GS}	-10, +2	VDC	25°C
Storage Temperature	T_{STG}	-55, +150	°C	
Maximum Forward Gate Current	I_G	27	mA	25°C
Maximum Drain Current	I_{DMAX}	13.5	A	
Soldering Temperature	T_S	260	°C	
Junction Temperature	T_J	225	°C	MTTF > 1e6 Hours

Electrical Characteristics (Frequency = 12.75 GHz to 13.25 GHz unless otherwise stated; $T_c = 25^\circ\text{C}$)

Characteristics	Symbol	Min.	Typ.	Max.	Units	Conditions
DC Characteristics						
Gate Threshold Voltage	$V_{GS(TH)}$	-3.1	-2.9	-2.7	V	$V_{DS} = 10\text{ V}, I_D = 27\text{ mA}$
Gate Quiescent Voltage	$V_{GS(Q)}$	-	-2.65	-	V _{DC}	$V_{DD} = 40\text{ V}, I_{DQ} = 750\text{ mA}$
Saturated Drain Current ¹	I_{DS}	25.8	26.2	-	A	$V_{DS} = 6.0\text{ V}, V_{GS} = 2.0\text{ V}$
Drain-Source Breakdown Voltage	V_{BD}	120	-	-	V	$V_{GS} = -8\text{ V}, I_D = 27\text{ mA}$
RF Characteristics²						
Small Signal Gain	S_{21_1}	-	25	-	dB	Pin = -15 dBm, Freq = 12.75 - 13.25 GHz
Output Power	P_{OUT1}	-	49.7	-	dBm	$V_{DD} = 40\text{ V}, I_{DQ} = 750\text{ mA}, P_{IN} = 33\text{ dBm}, \text{Freq} = 12.75\text{ GHz}$
Output Power	P_{OUT2}	-	49.9	-	dBm	$V_{DD} = 40\text{ V}, I_{DQ} = 750\text{ mA}, P_{IN} = 33\text{ dBm}, \text{Freq} = 13.0\text{ GHz}$
Output Power	P_{OUT3}	-	49.7	-	dBm	$V_{DD} = 40\text{ V}, I_{DQ} = 750\text{ mA}, P_{IN} = 33\text{ dBm}, \text{Freq} = 13.25\text{ GHz}$
Power Added Efficiency	PAE_1	-	23	-	%	$V_{DD} = 40\text{ V}, I_{DQ} = 750\text{ mA}, P_{IN} = 33\text{ dBm}, \text{Freq} = 12.75\text{ GHz}$
Power Added Efficiency	PAE_2	-	23	-	%	$V_{DD} = 40\text{ V}, I_{DQ} = 750\text{ mA}, P_{IN} = 33\text{ dBm}, \text{Freq} = 13.0\text{ GHz}$
Power Added Efficiency	PAE_3	-	21	-	%	$V_{DD} = 40\text{ V}, I_{DQ} = 750\text{ mA}, P_{IN} = 33\text{ dBm}, \text{Freq} = 13.25\text{ GHz}$
Power Gain	G_{P1}	-	16.7	-	dB	$V_{DD} = 40\text{ V}, I_{DQ} = 750\text{ mA}, P_{IN} = 33\text{ dBm}, \text{Freq} = 12.75\text{ GHz}$
Power Gain	G_{P2}	-	16.9	-	dB	$V_{DD} = 40\text{ V}, I_{DQ} = 750\text{ mA}, P_{IN} = 33\text{ dBm}, \text{Freq} = 13.0\text{ GHz}$
Power Gain	G_{P3}	-	16.7	-	dB	$V_{DD} = 40\text{ V}, I_{DQ} = 750\text{ mA}, P_{IN} = 33\text{ dBm}, \text{Freq} = 13.25\text{ GHz}$
Input Return Loss	S11	-	-18.6	-	dB	Pin = -15 dBm, 12.75 - 13.25 GHz
Output Return Loss	S22	-	-15.8	-	dB	Pin = -15 dBm, 12.75 - 13.25 GHz
IM3	IM3	-	-27	-	dBc	Pout/tone = 40 dBm, 10 MHz spacing
Output Mismatch Stress	VSWR	-	-	3 : 1	Ψ	No damage at all phase angles

Notes:

¹ Scaled from PCM data² Unless otherwise noted: Pin = 33 dBm, $V_{DD} = 40\text{ V}, I_{DQ} = 750\text{ mA}, \text{CW}$ **Thermal Characteristics**

Parameter	Symbol	Rating	Units	Conditions
Operating Junction Temperature	T_J	217	°C	CW, $P_{DISS} = 236\text{ W}, T_{CASE} = 85^\circ\text{C}$
Thermal Resistance, Junction to Case	$R_{\theta JC}$	0.56	°C/W	



Typical Performance of the CMPA1C1D080F

Test conditions unless otherwise noted: $V_D = 40\text{ V}$, $I_{DQ} = 750\text{ mA}$, CW, $P_{in} = 33\text{ dBm}$, $T_{BASE} = +25\text{ }^\circ\text{C}$

Figure 1. Output Power vs Frequency as a Function of Temperature

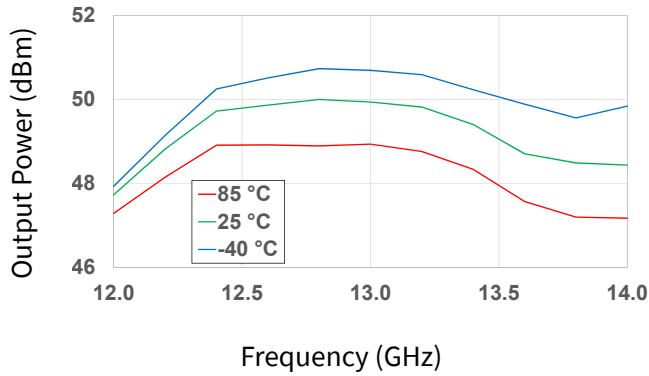

Figure 2. Output Power vs Frequency as a Function of Input Power

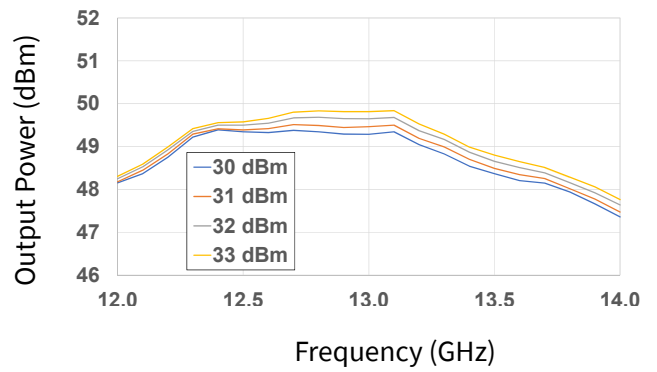

Figure 3. Power Added Eff. vs Frequency as a Function of Temperature

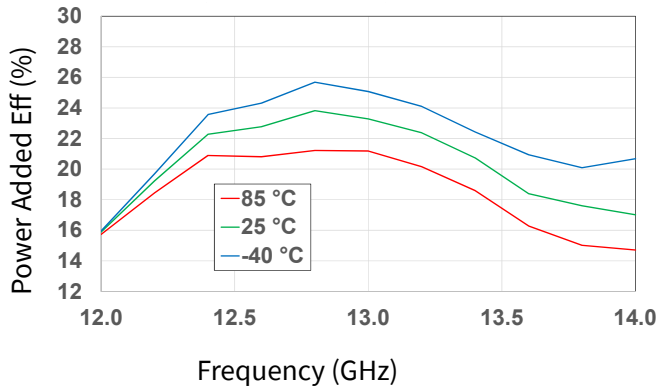

Figure 4. Power Added Eff. vs Frequency as a Function of Input Power

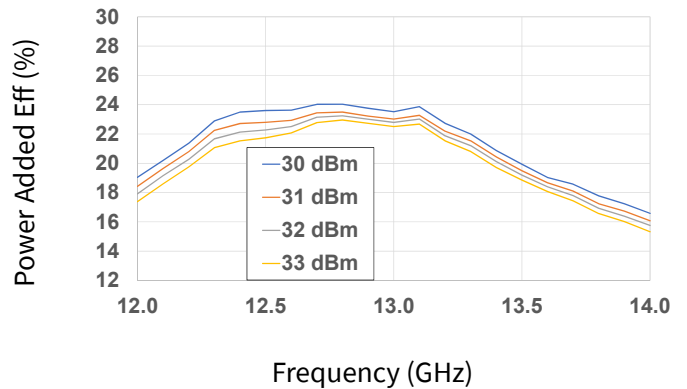

Figure 5. Drain Current vs Frequency as a Function of Temperature

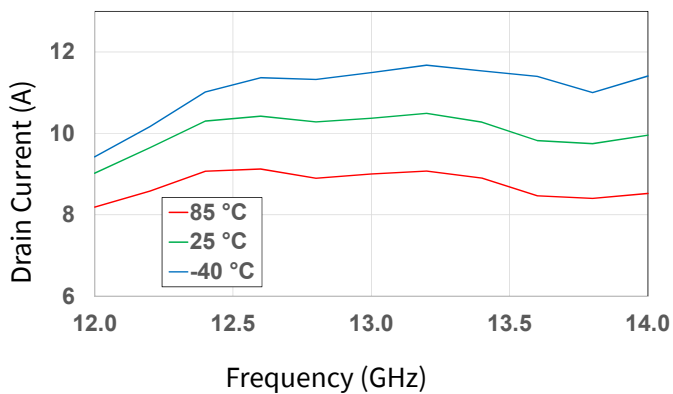
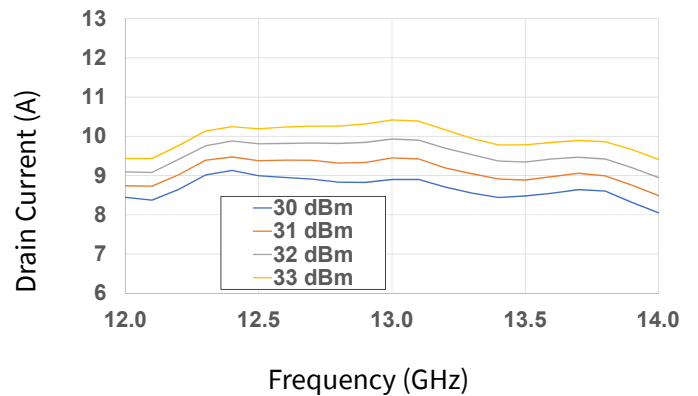

Figure 6. Drain Current vs Frequency as a Function of Input Power





Typical Performance of the CMPA1C1D080F

Test conditions unless otherwise noted: $V_D = 40\text{ V}$, $I_{DQ} = 750\text{ mA}$, CW, $P_{in} = 33\text{ dBm}$, $T_{BASE} = +25\text{ }^\circ\text{C}$

Figure 7. Output Power vs Frequency as a Function of V_D

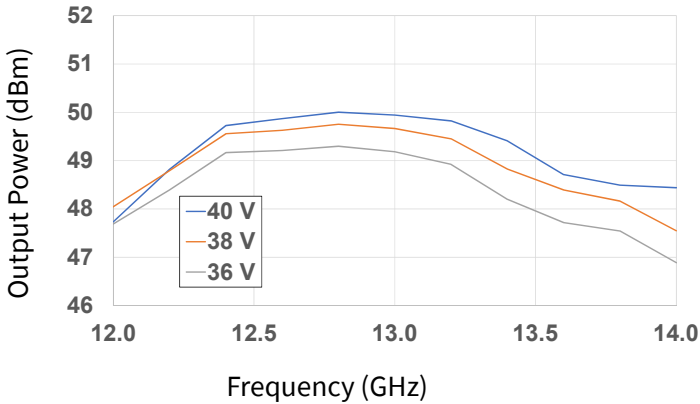

Figure 8. Output Power vs Frequency as a Function of I_{DQ}

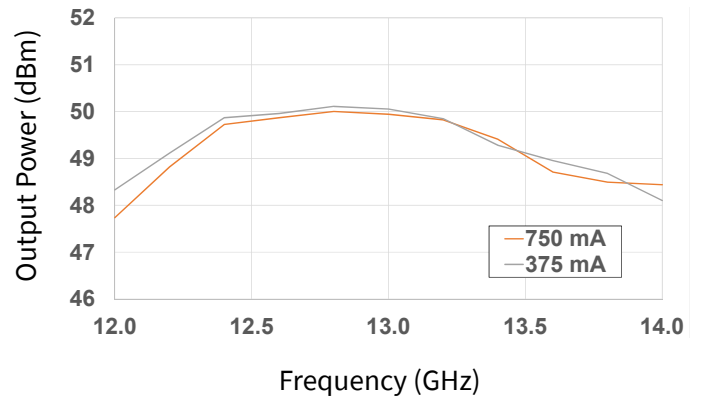

Figure 9. Power Added Eff. vs Frequency as a Function of V_D

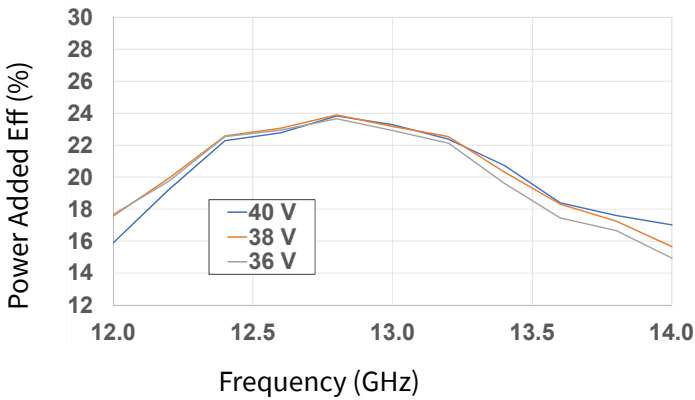

Figure 10. Power Added Eff. vs Frequency as a Function of I_{DQ}

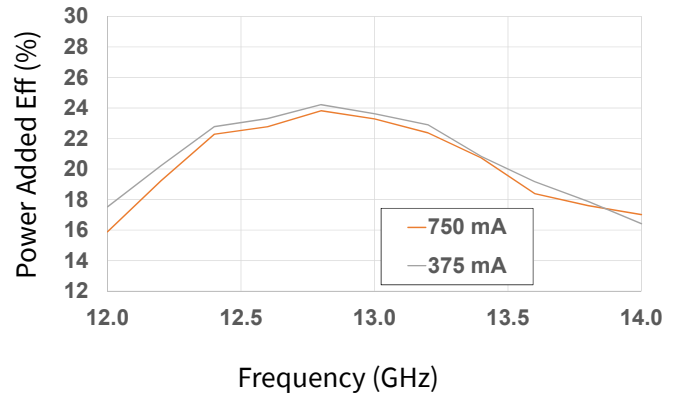

Figure 11. Drain Current vs Frequency as a Function of V_D

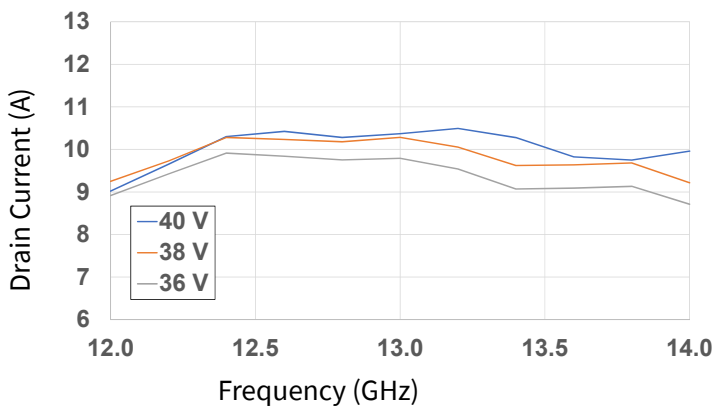
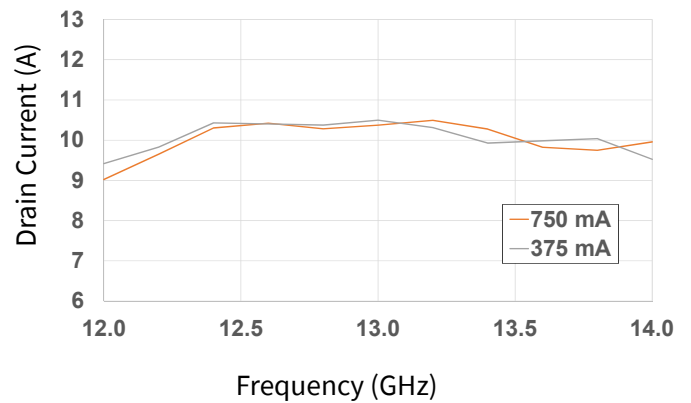

Figure 12. Drain Current vs Frequency as a Function of I_{DQ}





Typical Performance of the CMPA1C1D080F

Test conditions unless otherwise noted: $V_D = 40\text{ V}$, $I_{DQ} = 750\text{ mA}$, CW, $P_{in} = 33\text{ dBm}$, $T_{BASE} = +25\text{ }^\circ\text{C}$

Figure 13. Output Power vs Input Power as a Function of Frequency

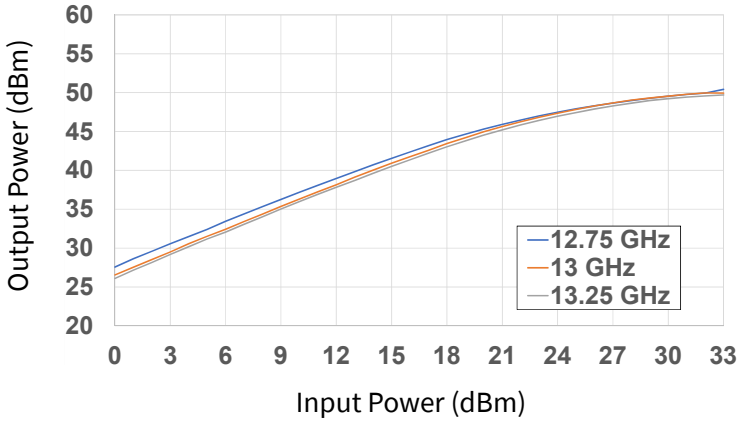

Figure 14. Power Added Eff. vs Input Power as a Function of Frequency

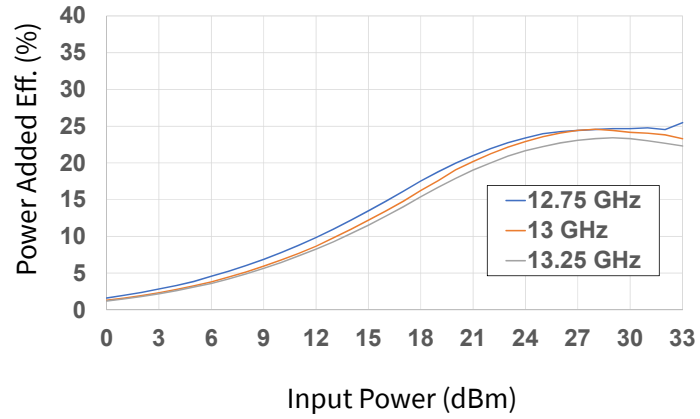

Figure 15. Large Signal Gain vs Input Power as a Function of Frequency

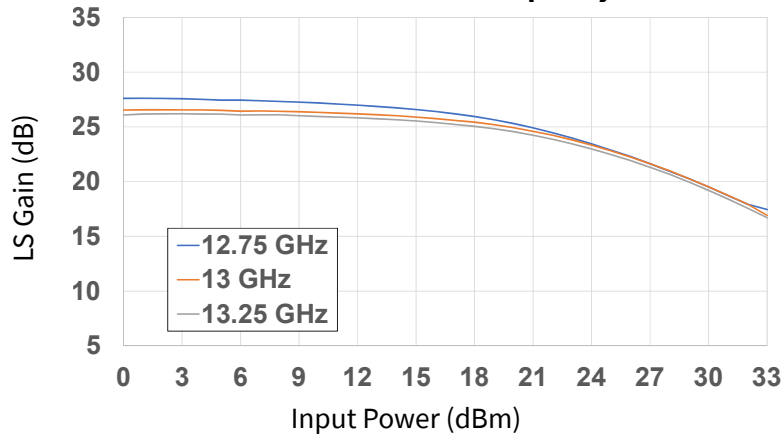

Figure 16. Drain Current vs Input Power as a Function of Frequency

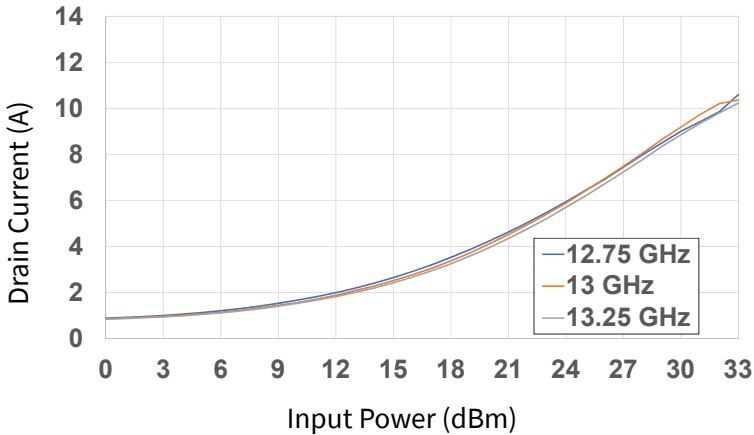
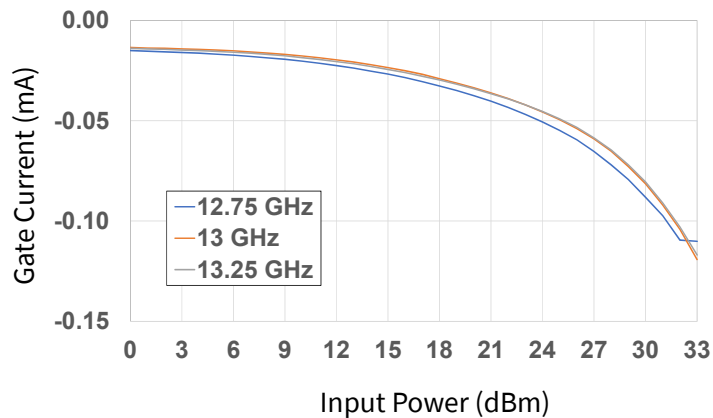

Figure 17. Gate Current vs Input Power as a Function of Frequency





Typical Performance of the CMPA1C1D080F

Test conditions unless otherwise noted: $V_D = 40\text{ V}$, $I_{DQ} = 750\text{ mA}$, CW, $P_{in} = 33\text{ dBm}$, $T_{BASE} = +25\text{ }^\circ\text{C}$

Figure 18. Output Power vs Input Power as a Function of Temperature

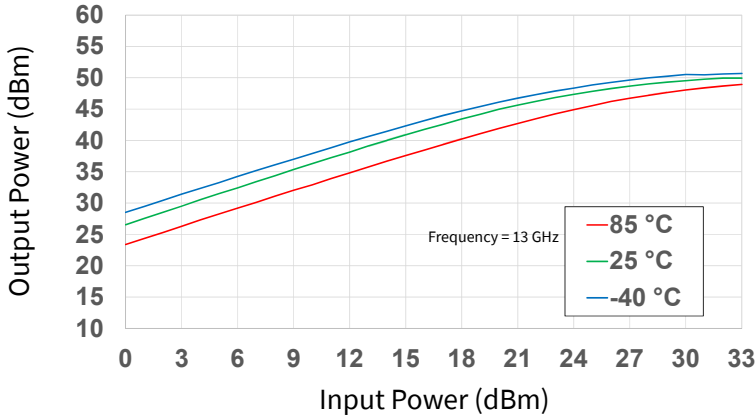

Figure 19. Power Added Eff. vs Input Power as a Function of Temperature

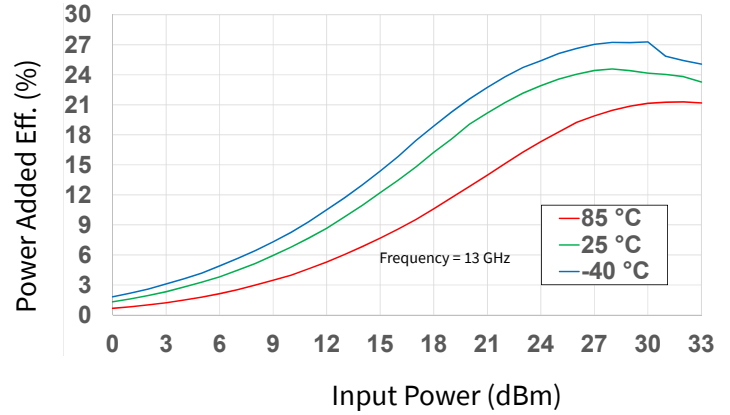

Figure 20. Large Signal Gain vs Input Power as a Function of Temperature

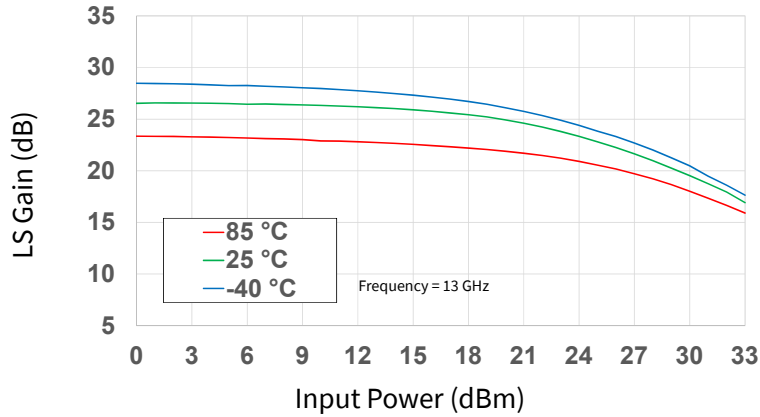

Figure 21. Drain Current vs Input Power as a Function of Temperature

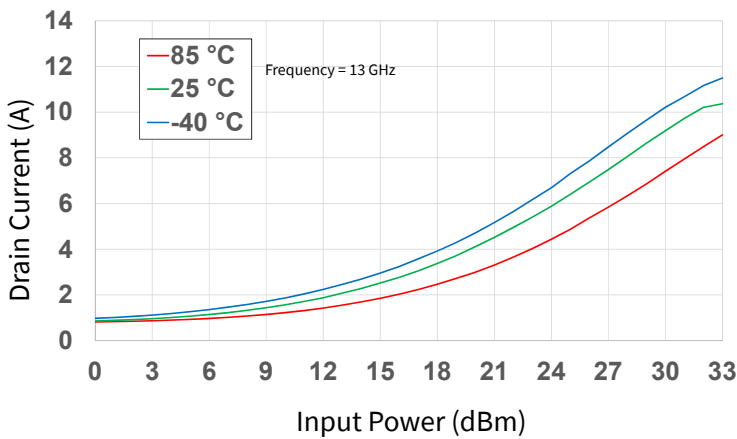
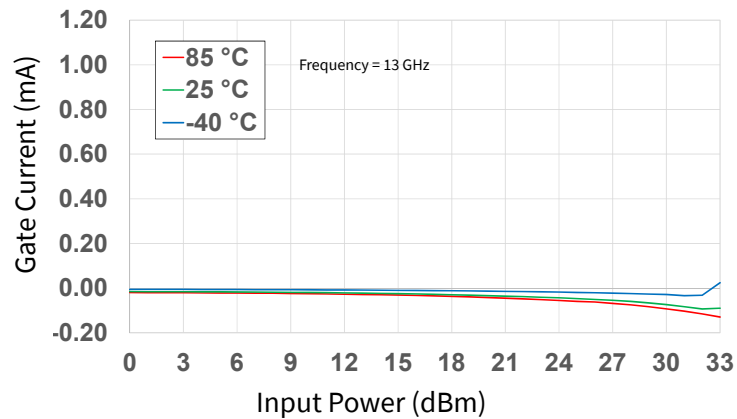

Figure 22. Gate Current vs Input Power as a Function of Temperature





Typical Performance of the CPM1C1D080F

Test conditions unless otherwise noted: $V_D = 40\text{ V}$, $I_{DQ} = 750\text{ mA}$, CW, $P_{in} = 33\text{ dBm}$, $T_{BASE} = +25\text{ }^\circ\text{C}$

Figure 23. Output Power vs Input Power as a Function of IDQ

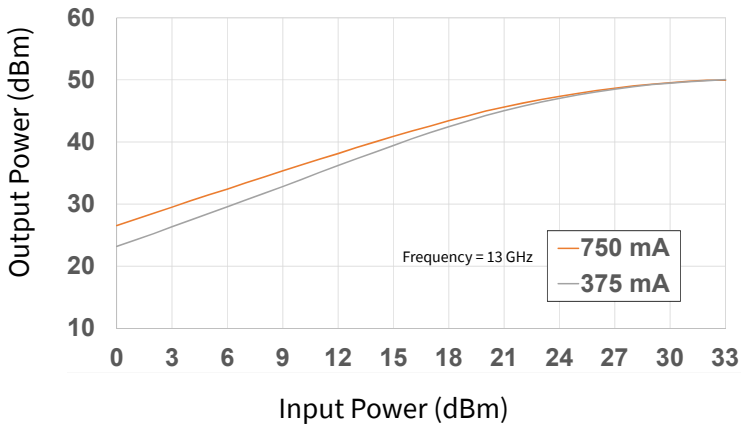

Figure 24. Power Added Eff. vs Input Power as a Function of IDQ

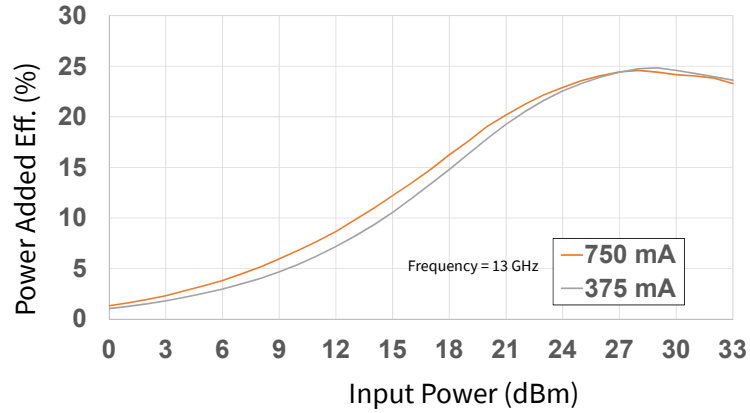

Figure 25. Large Signal Gain vs Input Power as a Function of IDQ

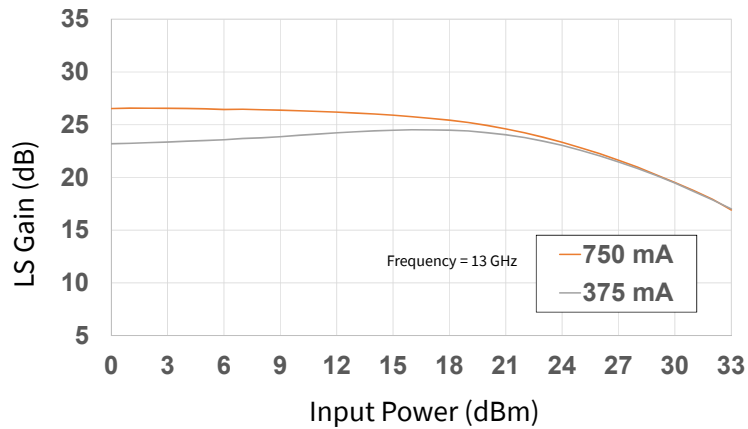

Figure 26. Drain Current vs Input Power as a Function of IDQ

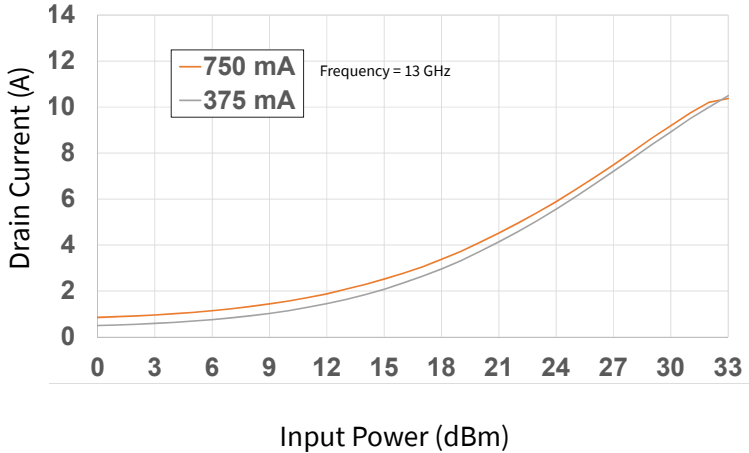
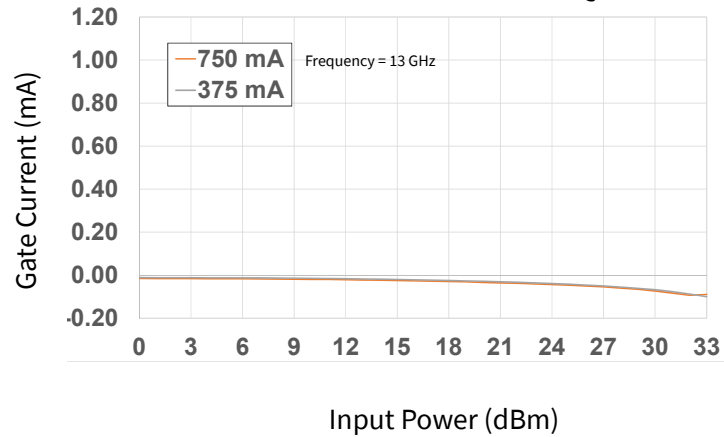

Figure 27. Gate Current vs Input Power as a Function of IDQ





Typical Performance of the CMPA1C1D080F

Test conditions unless otherwise noted: $V_D = 40\text{ V}$, $I_{DQ} = 750\text{ mA}$, $P_{in} = -15\text{ dBm}$, $T_{BASE} = +25\text{ }^\circ\text{C}$

Figure 28. Gain vs Frequency as a Function of Temperature

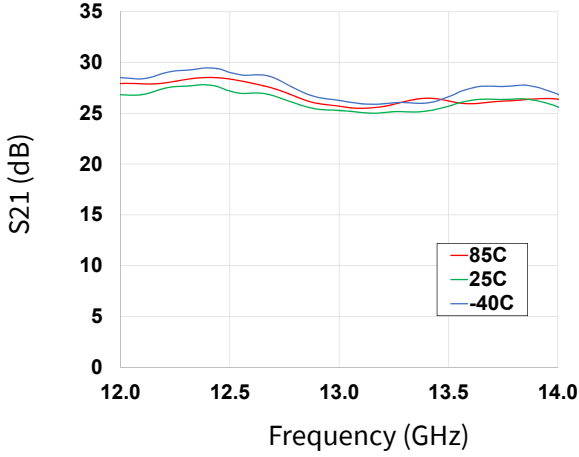

Figure 29. Gain vs Frequency as a Function of Temperature

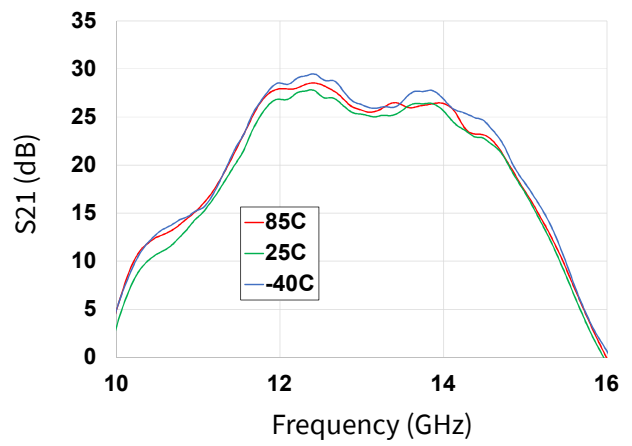

Figure 30. Input RL vs Frequency as a Function of Temperature

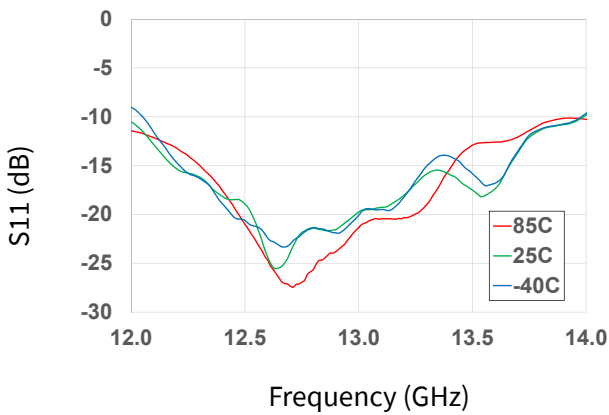

Figure 31. Input RL vs Frequency as a Function of Temperature

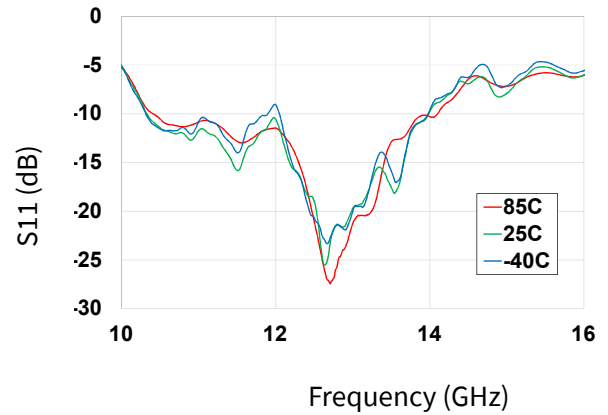

Figure 32. Output RL vs Frequency as a Function of Temperature

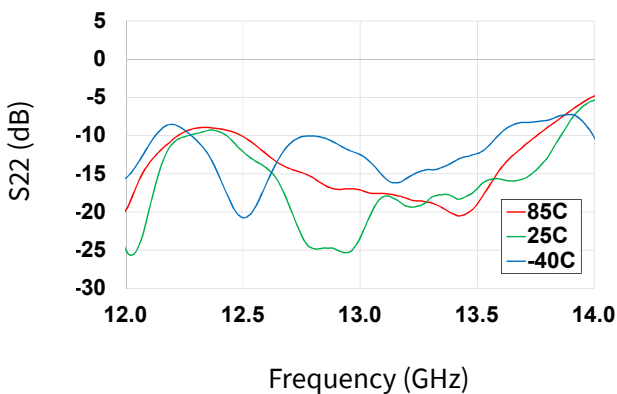
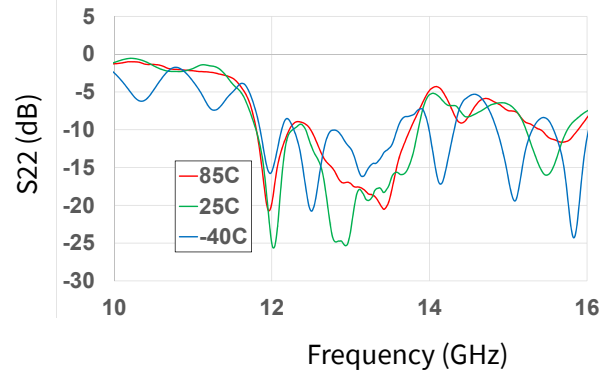

Figure 33. Output RL vs Frequency as a Function of Temperature





Typical Performance of the CMPA1C1D080F

Test conditions unless otherwise noted: $V_D = 40\text{ V}$, $I_{DQ} = 750\text{ mA}$, $P_{in} = -15\text{ dBm}$, $T_{BASE} = +25\text{ }^\circ\text{C}$

Figure 34. Gain vs Frequency as a Function of Voltage

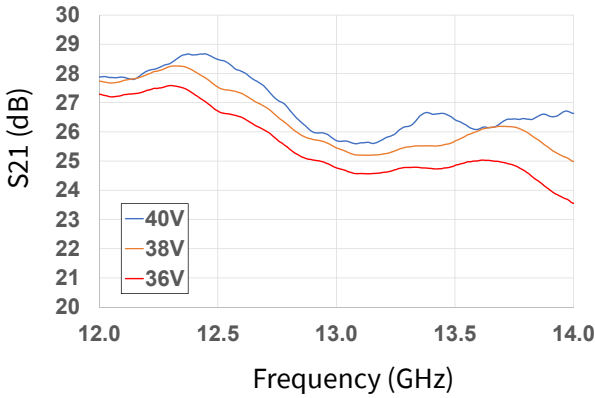

Figure 35. Gain vs Frequency as a Function of IDQ

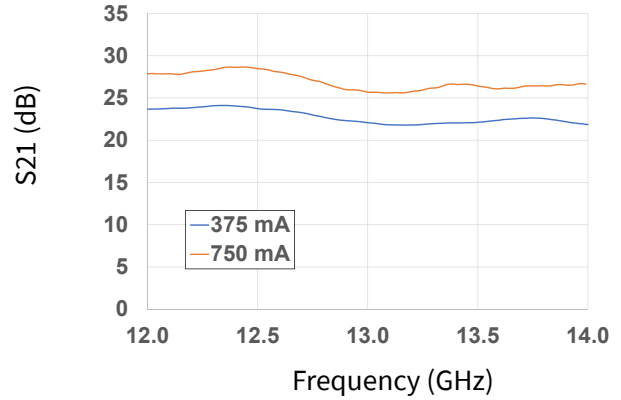

Figure 36. Input RL vs Frequency as a Function Voltage

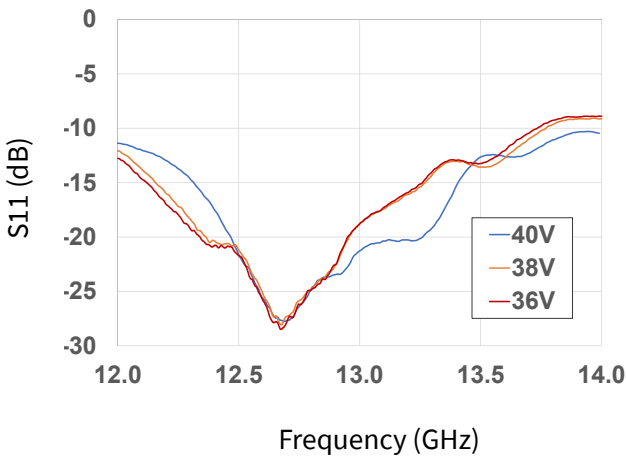

Figure 37. Input RL vs Frequency as a Function of IDQ

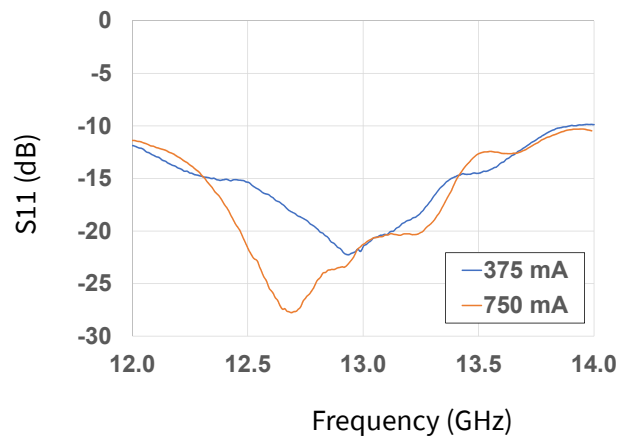

Figure 38. Output RL vs Frequency as a Function of Voltage

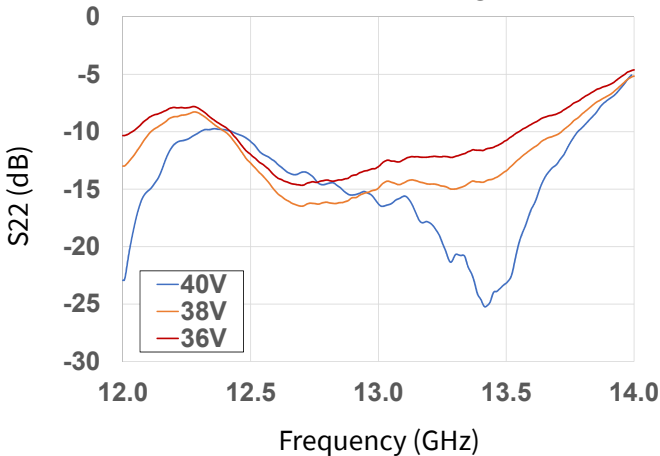
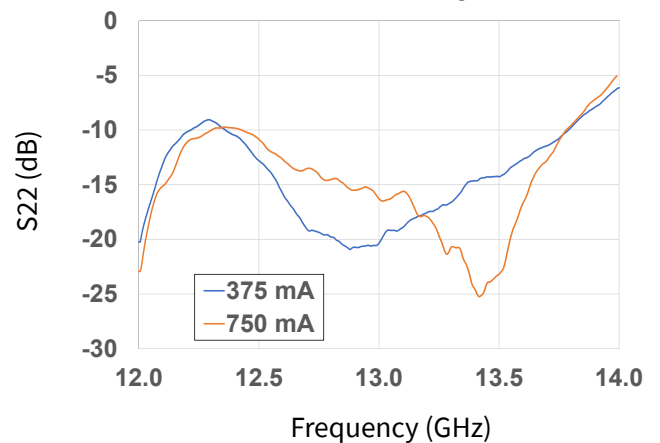

Figure 39. Output RL vs Frequency as a Function of IDQ





Typical Performance of the CMPA1C1D080F

Test conditions unless otherwise noted: $V_D = 40\text{ V}$, $I_{DQ} = 750\text{ mA}$, CW, Pin = 33 dBm, Tone Spacing = 10 MHz, $T_{BASE} = +25\text{ }^\circ\text{C}$

Figure 40. IM3 vs Output Power as a Function of Temperature

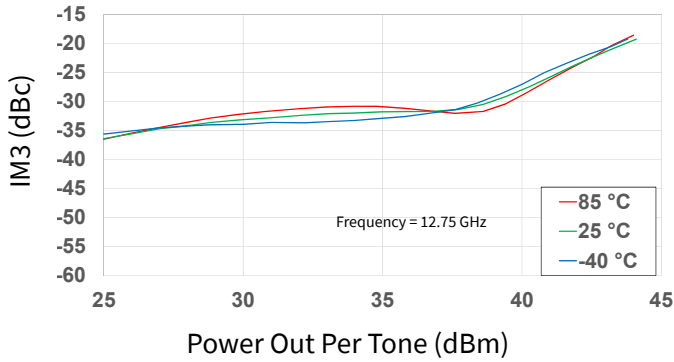

Figure 41. IM5 vs Output Power as a Function of Temperature

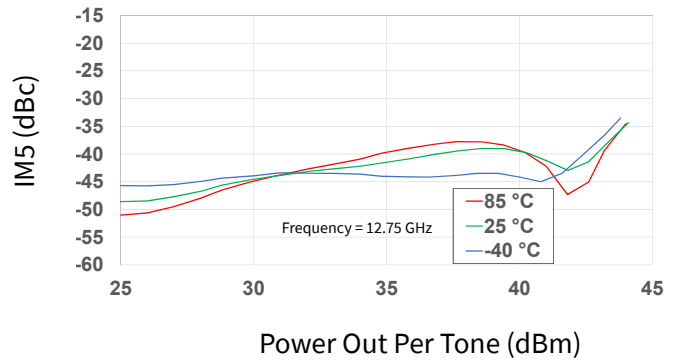

Figure 42. IM3 vs Output Power as a Function of IDQ

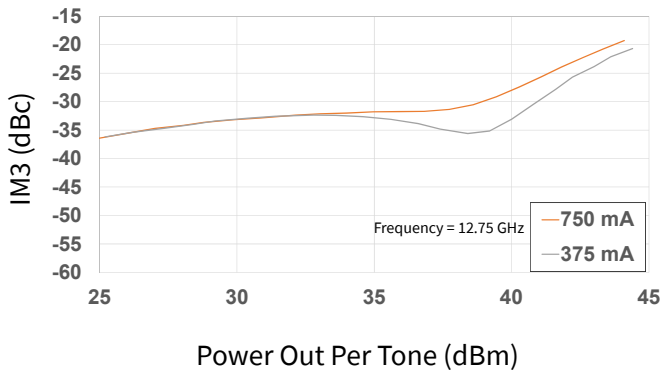

Figure 43. IM5 vs Output Power as a Function of IDQ

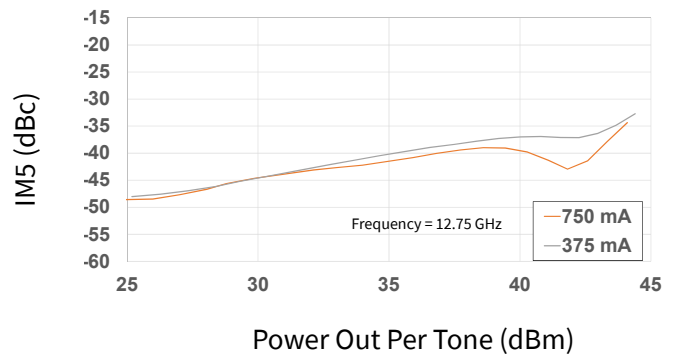

Figure 44. IM3 vs Output Power as a Function of Tone Spacing

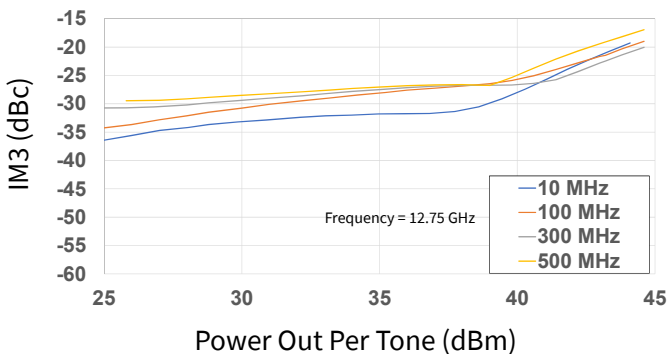
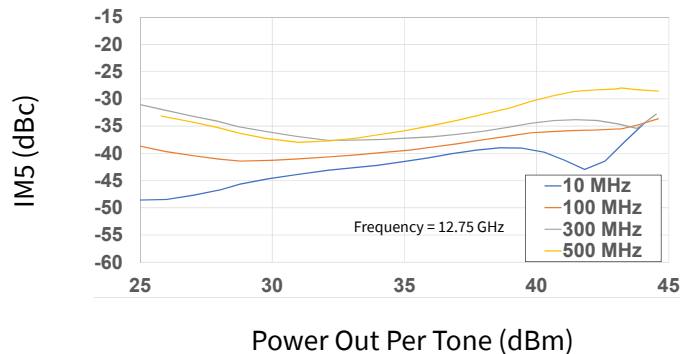

Figure 45. IM5 vs Output Power as a Function of Tone Spacing



Typical Performance of the CMPA1C1D080F

Test conditions unless otherwise noted: $V_D = 40\text{ V}$, $I_{DQ} = 750\text{ mA}$, CW, Pin = 33 dBm, Tone Spacing = 10 MHz, $T_{BASE} = +25\text{ }^\circ\text{C}$

Figure 46. IM3 vs Output Power as a Function of Temperature

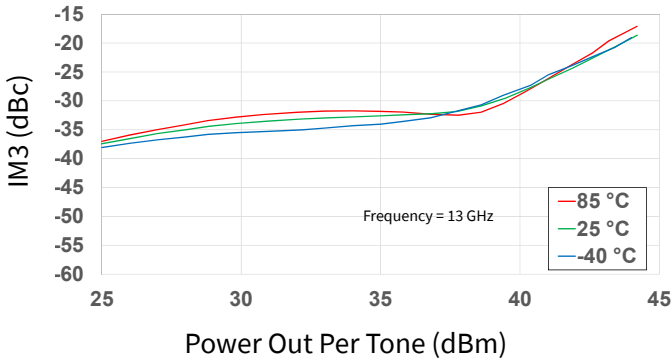

Figure 47. IM5 vs Output Power as a Function of Temperature

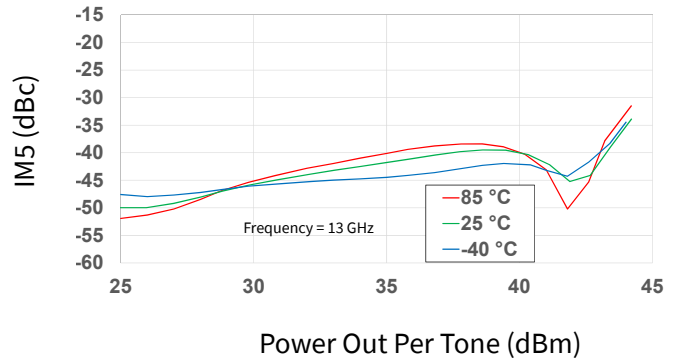

Figure 48. IM3 vs Output Power as a Function of IDQ

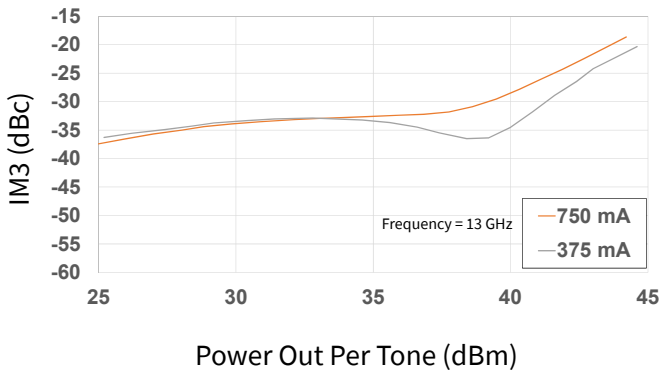

Figure 49. IM5 vs Output Power as a Function of IDQ

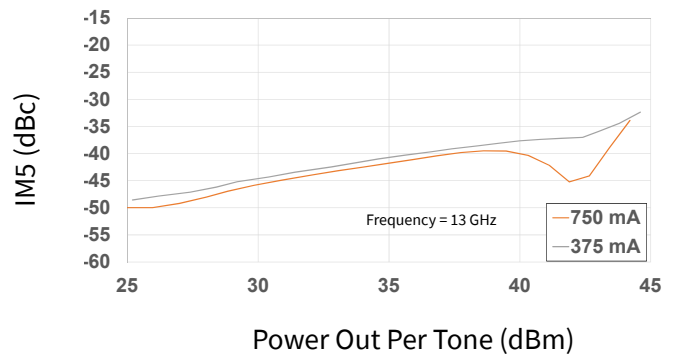

Figure 50. IM3 vs Output Power as a Function of Tone Spacing

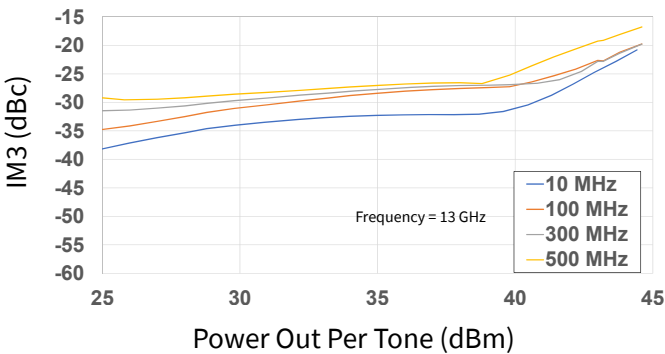
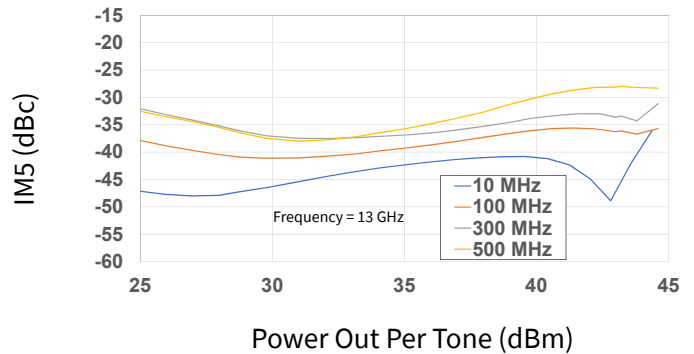

Figure 51. IM5 vs Output Power as a Function of Tone Spacing



Typical Performance of the CMPA1C1D080F

Test conditions unless otherwise noted: $V_D = 40\text{ V}$, $I_{DQ} = 750\text{ mA}$, CW, Pin = 33 dBm, Tone Spacing = 10 MHz, $T_{BASE} = +25\text{ }^\circ\text{C}$

Figure 52. IM3 vs Output Power as a Function of Temperature

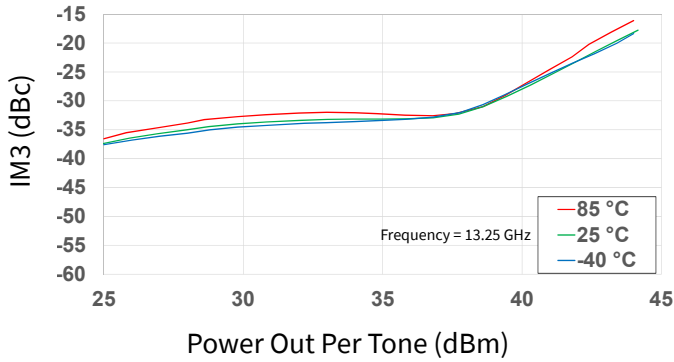

Figure 53. IM5 vs Output Power as a Function of Temperature

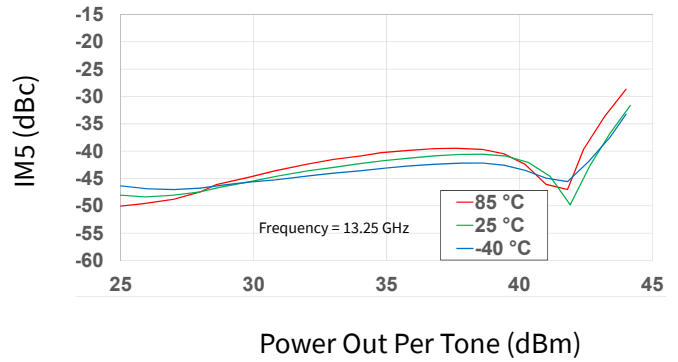

Figure 54. IM3 vs Output Power as a Function of IDQ

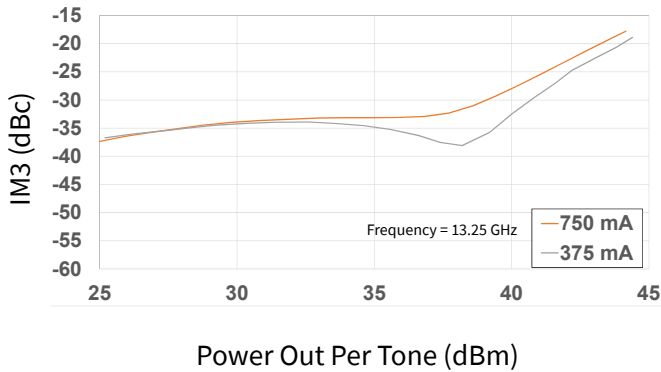

Figure 55. IM5 vs Output Power as a Function of IDQ

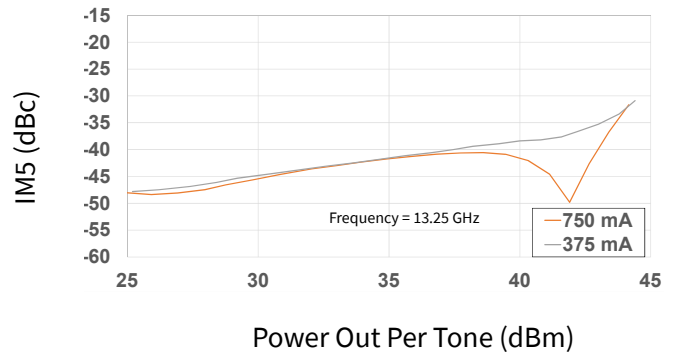

Figure 56. IM3 vs Output Power as a Function of Tone Spacing

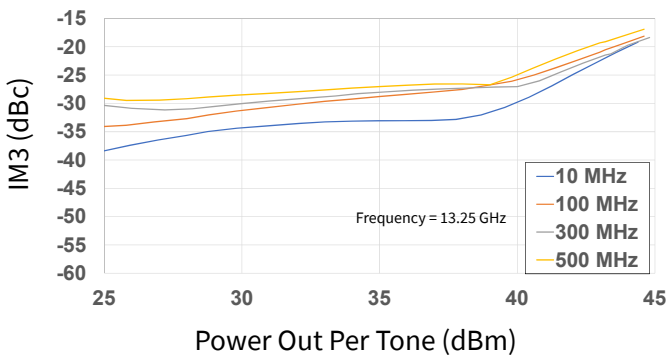
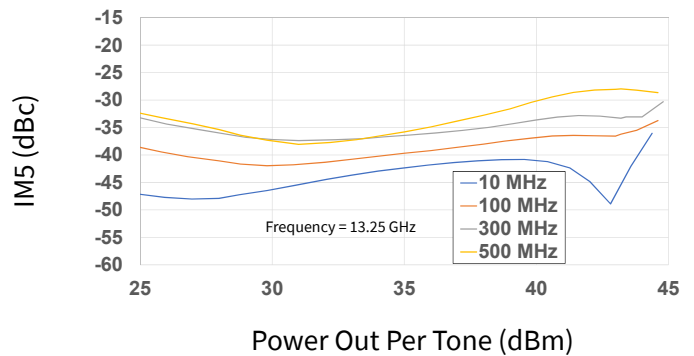

Figure 57. IM5 vs Output Power as a Function of Tone Spacing



Typical Performance of the CMPA1C1D080F

Test conditions unless otherwise noted: $V_D = 40\text{ V}$, $I_{DQ} = 750\text{ mA}$, CW, $P_{in} = 33\text{ dBm}$, Tone Spacing = 10 MHz, $T_{BASE} = +25\text{ }^\circ\text{C}$

Figure 58. IM3 vs Tone Spacing as a Function of Frequency

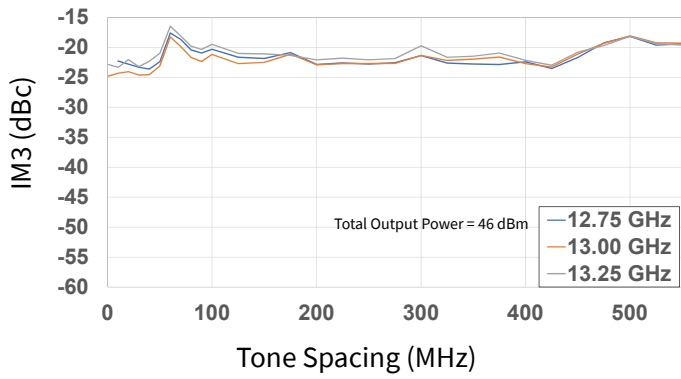
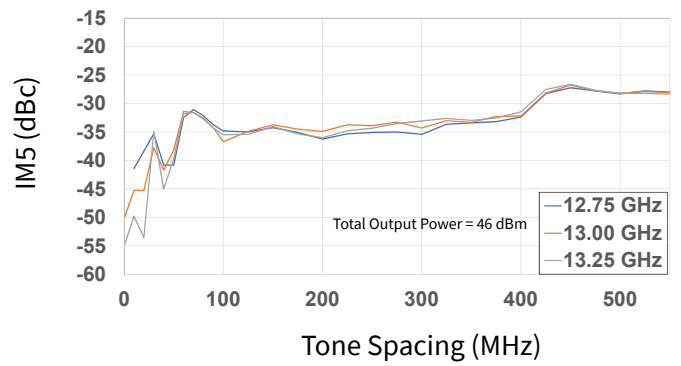
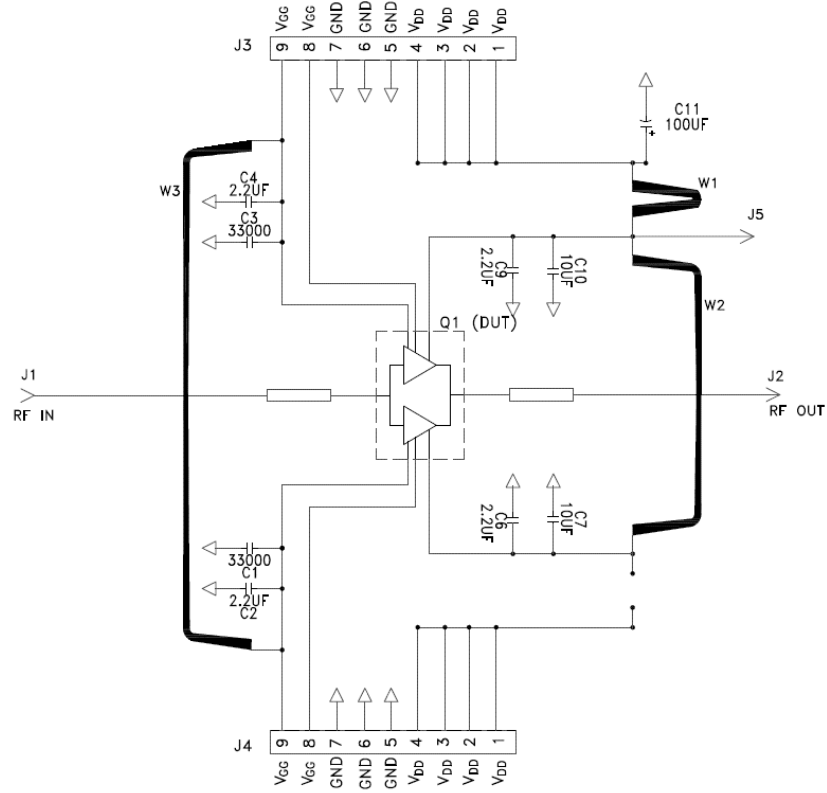

Figure 59. IM5 vs Tone Spacing as a Function of Frequency



CMPA1C1D080F-AMP Evaluation Board Schematic



CMPA1C1D080F-AMP Evaluation Board Outline

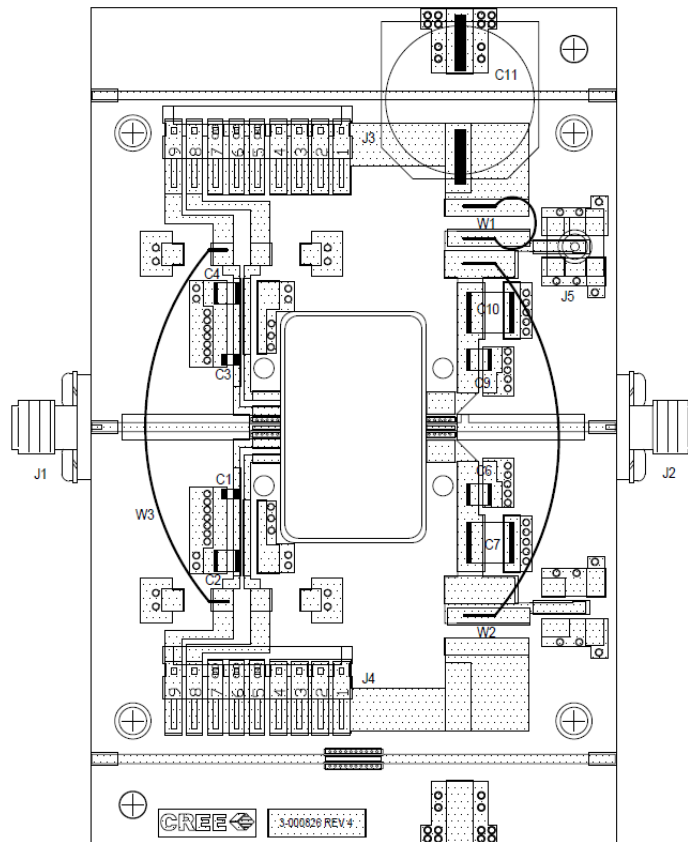

CMPA1C1D080F-AMP Evaluation Board Bill of Materials

Designator	Description	Qty
C1,C3	CAP, 33000PF, 0805,100V, X7R	2
C2,C4,C6,C9	CAP, 2.2UF, 100V, 10%, X7R, 1210	4
C7,C10	CAP, 10UF, 100V, 10%, X7R, 2220	2
C11	CAP, 100 UF, 20%, 160V, ELEC	1
W1	WIRE, 18 AWG ~ 3"	1
W2,W3	WIRE, 18 AWG ~ 1.75"	2
J1,J2	CONN, SMA, PANEL MOUNT JACK, FLANGE, 4-HOLE, BLUNT POST, 20MIL	2
J3,J4	HEADER RT>PLZ .1CEN LK 9POS	2
J5	CONN, SMB, STRAIGHT JACK RECEPTACLE, SMT, 50 OHM, Au PLATED	1
Q1	CMPA1C1D080F, 80W, 12.7-13.25GHz, GaN MMIC, 40V	1
	PCB, TEST FIXTURE, 440222 PKG	1
	BASEPLATE, CU, 2.5 X 4.0 X 0.5 IN	1
	2-56 SOC HD SCREW 1/4 SS	4
	#2 SPLIT LOCKWASHER SS	4
	CMPA1C1D080F	1

Electrostatic Discharge (ESD) Classifications

Parameter	Symbol	Class	Test Methodology
Human Body Model	HBM	1B (≥ 500 V)	JEDEC JESD22 A114-D
Charge Device Model	CDM	II (≥ 200 V)	JEDEC JESD22 C101-C

Moisture Sensitivity Level (MSL) Classification

Parameter	Symbol	Level	Test Methodology
Moisture Sensitivity Level	MSL	3 (168 hours)	IPC/JEDEC J-STD-20

Product Dimensions CMPA1C1D080F (Package 440222)

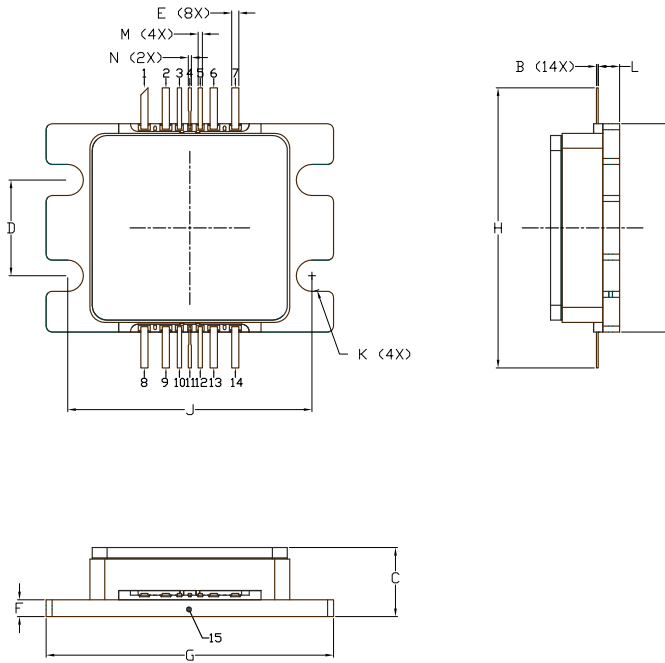

NOTES:

1. DIMENSIONING AND TOLERANCING PER ANSI Y14.5M, 1982.
2. CONTROLLING DIMENSION: INCH.
3. ADHESIVE FROM LID MAY EXTEND A MAXIMUM OF 0.020" BEYOND EDGE OF LID.
4. LID MAY BE MISALIGNED TO THE BODY OF THE PACKAGE BY A MAXIMUM OF 0.008" IN ANY DIRECTION.
5. ALL PLATED SURFACES ARE NI/AU

DIM	INCHES		MILLIMETERS	
	MIN	MAX	MIN	MAX
A	0.679	0.691	17.25	17.55
B	0.003	0.006	0.076	0.152
C	0.214	0.241	5.44	6.12
D	0.307	0.323	7.80	8.20
E	0.016	0.032	0.406	0.813
F	0.047	0.063	1.194	1.600
G	0.936	0.954	23.77	24.23
H	0.912	0.930	23.16	23.62
J	0.795	0.811	20.19	20.60
K	∅0.094	∅0.110	∅2.39	∅2.79
L	0.062	0.078	1.575	1.981
M	0.006	0.022	0.152	0.559
N	0.004	0.018	0.102	0.457

PIN	DESC.
1	Bias Gate 2
2	Bias Gate 2
3	GND
4	RF IN
5	GND
6	Bias Gate 1
7	Bias Gate 1
8	Bias Drain 2
9	Bias Drain 2
10	GND
11	RF OUT
12	GND
13	Bias Drain 1
14	Bias Drain 1

Part Number System

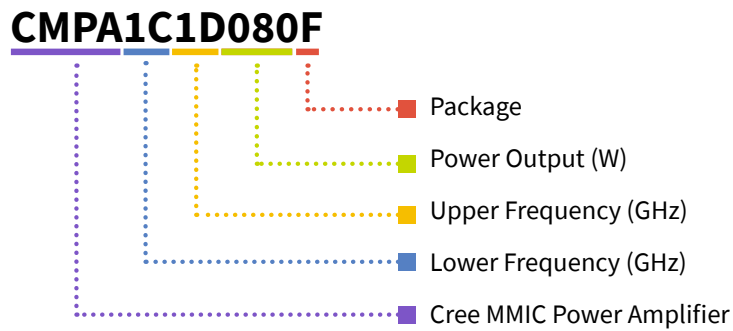

Table 1.

Parameter	Value	Units
Lower Frequency	12.75	GHz
Upper Frequency	13.25	GHz
Power Output	80	W
Package	Flange	-

Note¹: Alpha characters used in frequency code indicate a value greater than 9.9 GHz. See Table 2 for value.

Table 2.

Character Code	Code Value
A	0
B	1
C	2
D	3
E	4
F	5
G	6
H	7
J	8
K	9
Examples:	1A = 10.0 GHz 2H = 27.0 GHz