

CMPA2060035F

35 W, 2.0 - 6.0 GHz, GaN MMIC Power Amplifier

Description

Wolfspeed's CMPA2060035F is a gallium nitride (GaN) High Electron Mobility Transistor (HEMT) based monolithic microwave integrated circuit (MMIC). GaN has superior properties compared to silicon or gallium arsenide, including higher breakdown voltage, higher saturated electron drift velocity and higher thermal conductivity. GaN HEMTs also offer greater power density and wider bandwidths compared to Si and GaAs transistors. This MMIC contains a two-stage reactively matched amplifier enabling very wide bandwidths to be achieved in a small footprint screw-down package featuring a Copper-Tungsten heat-sink.

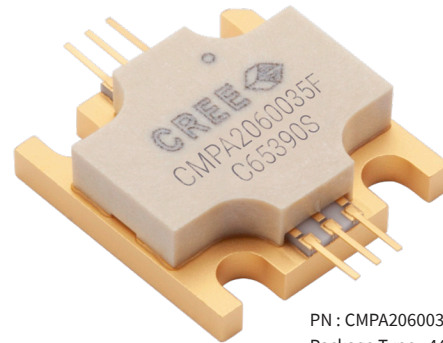

PN : CMPA2060035F
Package Type : 440219

Features

- 28 dB Small Signal Gain
- 35 W Typical P_{SAT}
- Operation up to 28 V
- High Breakdown Voltage
- High Temperature Operation

Applications

- Ultra Broadband Amplifiers
- Fiber Drivers
- Test Instrumentation
- EMC Amplifier Drivers

Typical Performance Over 2.0-6.0 GHz, 28 V ($T_c = 25^\circ\text{C}$)

Parameter	2.0 GHz	4.0 GHz	6.0 GHz	Units
Small Signal Gain	24.8	26.5	25.0	dB
Output Power ¹	30.0	44.7	32.5	W
Power Gain ¹	17.7	19.5	18.1	dB
Power Added Efficiency ¹	43	47	36	%

Notes:

¹ $V_{DD} = 28\text{ V}$, $I_{DQ} = 1.2\text{ A}$, $P_{IN} = 27\text{ dBm}$. All data tested CW



Absolute Maximum Ratings (not simultaneous) at 25 °C

Parameter	Symbol	Rating	Units	Conditions
Drain-source Voltage	V_{DS}	84	VDC	
Gate-source Voltage	V_{GS}	-10, +2	VDC	
Storage Temperature	T_{STG}	-65, +150	°C	
Operating Junction Temperature	T_J	225	°C	
Forward Gate Current	I_G	16	mA	
Screw Torque	T	40	in-oz	
Thermal Resistance, Junction to Case	$R_{\theta JC}$	2.06	°C/W	85 °C, $P_{DISS} = 65$ W, CW
Case Operating Temperature	T_C	-40, +150	°C	

Electrical Characteristics (Frequency = 2.0 GHz to 6.0 GHz unless otherwise stated; $T_C = 25$ °C)

Characteristics	Symbol	Min.	Typ.	Max.	Units	Conditions
DC Characteristics^{1,2}						
Gate Threshold Voltage	$V_{(GS)TH}$	-3.4	-3.0	-2.7	V	$V_{DS} = 10$ V, $I_D = 16.5$ mA
Gate Quiescent Voltage	$V_{(GS)Q}$	-	-2.6	-	V_{DC}	$V_{DD} = 28$ V, $I_D = 1.2$ A
Saturated Drain Current ¹	I_{DS}	11.9	16.5	-	A	$V_{DS} = 6.0$ V, $V_{GS} = 2.0$ V
Drain-Source Breakdown Voltage	V_{BD}	84	-	-	V	$V_{GS} = -8$ V, $I_D = 16.5$ mA
RF Characteristics^{3,4,5}						
Small Signal Gain	S21	22.2	26.5	-	dB	$V_{DD} = 28$ V, $I_{DQ} = 1.2$ A, Frequency = 2.0 - 6.0 GHz
Input Return Loss	S11	-	-11	-4	dB	$V_{DD} = 28$ V, $I_{DQ} = 1.2$ A, Frequency = 2.0 - 6.0 GHz
Output Return Loss	S22	-	-11.6	-4	dB	$V_{DD} = 28$ V, $I_{DQ} = 1.2$ A, Frequency = 2.0 - 6.0 GHz
Output Power ₁	P_{OUT}	23.7	30.0	-	W	$V_{DD} = 28$ V, $I_{DQ} = 1.2$ A, Freq = 2.0 GHz
Output Power ₂	P_{OUT}	34.3	44.7	-	W	$V_{DD} = 28$ V, $I_{DQ} = 1.2$ A, Freq = 4.0 GHz
Output Power ₃	P_{OUT}	23.7	32.5	-	W	$V_{DD} = 28$ V, $I_{DQ} = 1.2$ A, Freq = 6.0 GHz
Power Added Efficiency ₁	PAE	34.5	43	-	%	$V_{DD} = 28$ V, $I_{DQ} = 1.2$ A, Freq = 2.0 GHz
Power Added Efficiency ₂	PAE	37	47	-	%	$V_{DD} = 28$ V, $I_{DQ} = 1.2$ A, Freq = 4.0 GHz
Power Added Efficiency ₃	PAE	23	36	-	%	$V_{DD} = 28$ V, $I_{DQ} = 1.2$ A, Freq = 6.0 GHz
Output Mismatch Stress	VSWR	-	-	5 : 1	Ψ	No damage at all phase angles, $V_{DD} = 28$ V, $I_{DQ} = 1.2$ A, $P_{IN} = 27$ dBm

Notes:

¹ Measured on-wafer prior to packaging

² Scaled from PCM data

³ Measured in CMPA2060035F-AMP

⁴ Measured at $P_{IN} = 27$ dBm

⁵ Tested CW



Typical Performance

Figure 1. CMPA2060035F S21 vs. Frequency

$I_{DQ} = 1.2 \text{ A}$

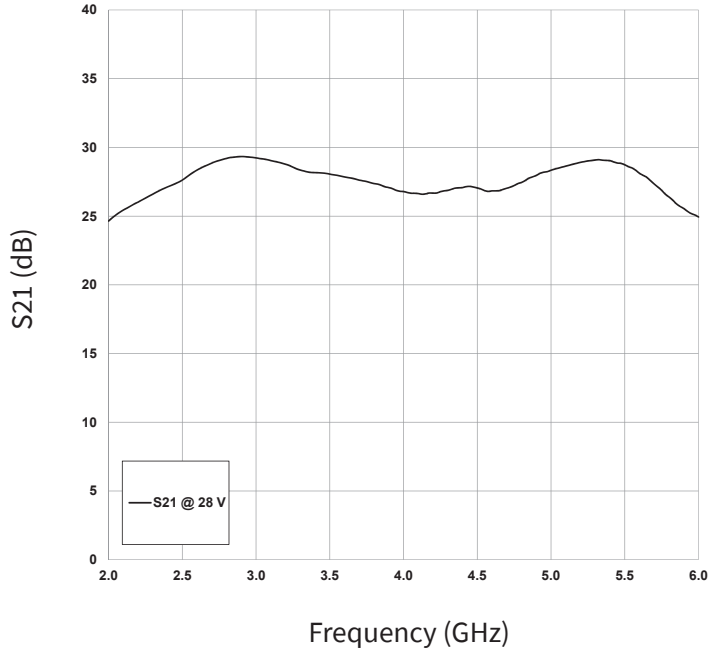
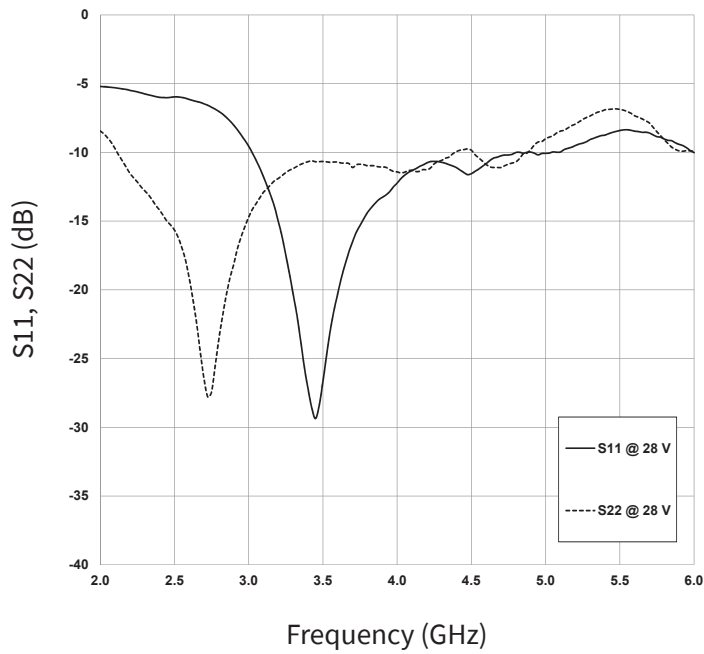

Figure 2. CMPA2060035F Return Losses vs. Frequency

$I_{DQ} = 1.2 \text{ A}$





Typical Performance

Figure 3. CPM2060035F Output Power and Power Added Efficiency vs. Frequency

$I_{DQ} = 1.2 \text{ A}$, Case Temperature = 25 °C, Power Input = 27 dBm

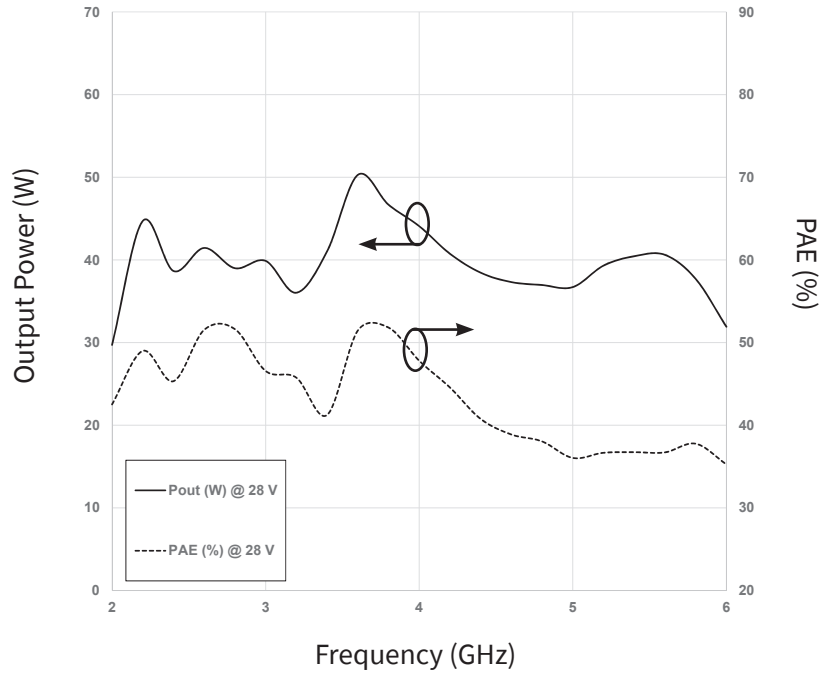
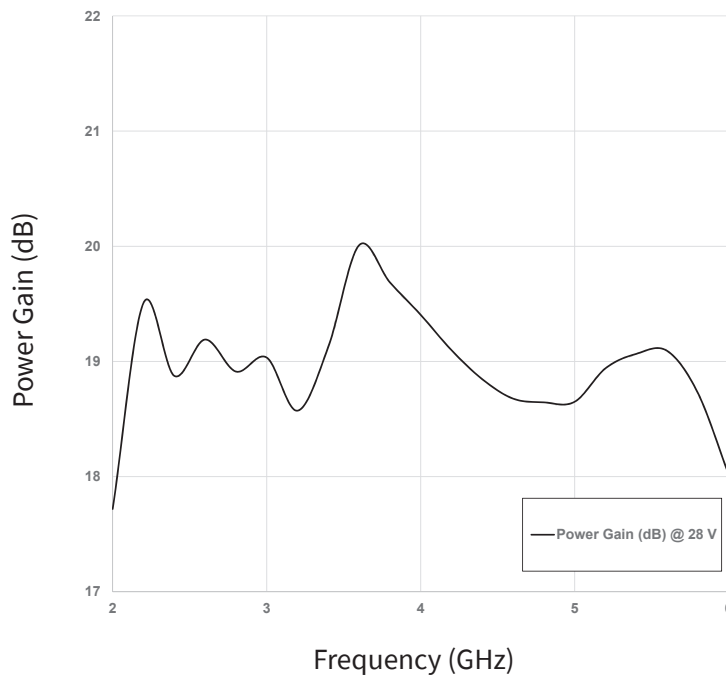

Figure 4. CPM2060035F Power Gain vs. Frequency

$I_{DQ} = 1.2 \text{ A}$





Typical Performance

CPA2060035F CW Power Dissipation De-rating Curve

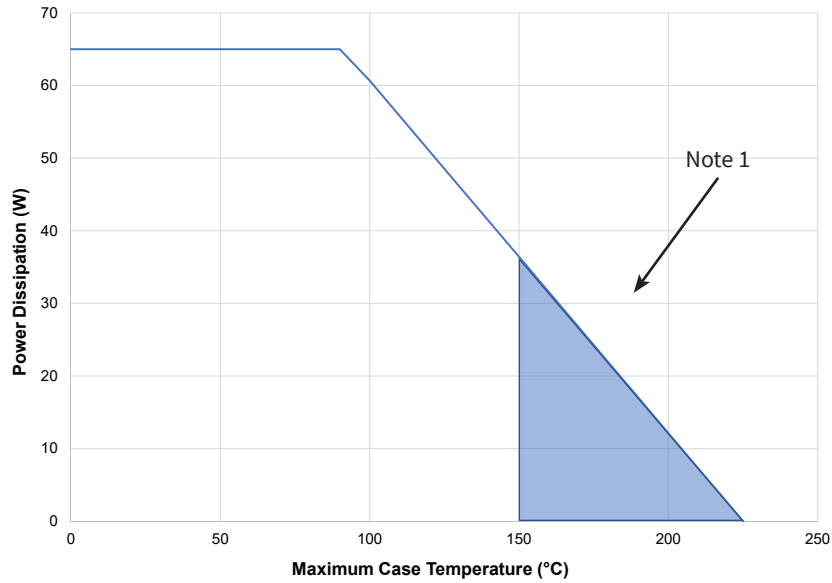

Note 1. Area exceeds Maximum Case Operating Temperature (See Page 2).

Electrostatic Discharge (ESD) Classifications

Parameter	Symbol	Class	Test Methodology
Human Body Model	HBM	1A (> 250 V)	JEDEC JESD22 A114-D
Charge Device Model	CDM	II (200 < 500 V)	JEDEC JESD22 C101-C



CMPA2060035F-AMP Demonstration Amplifier Circuit Schematic

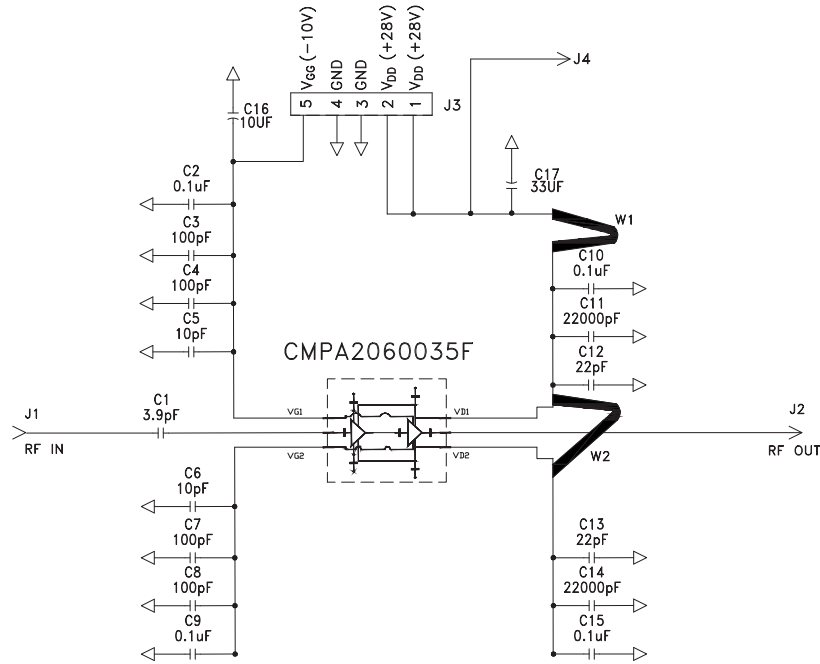

CMPA2060035F-AMP Demonstration Amplifier Circuit Outline

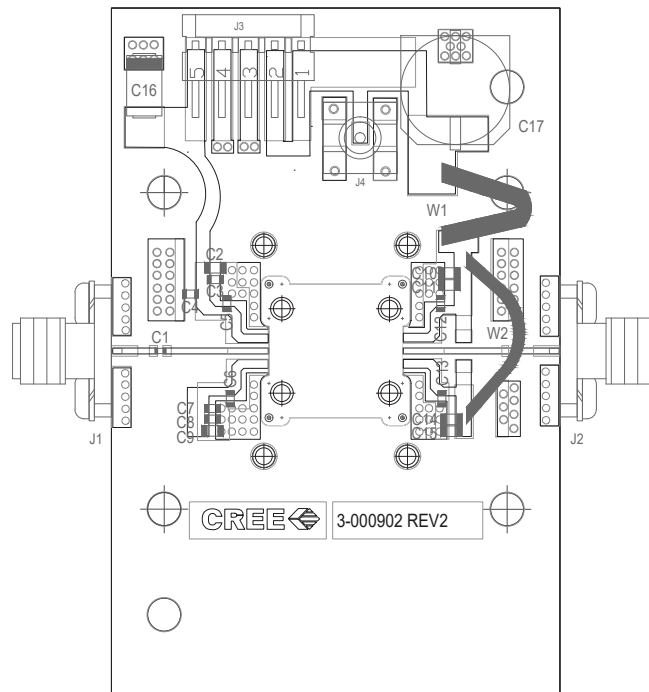



CMPA2060035F-AMP Demonstration Amplifier Circuit Bill of Materials

Designator	Description	Qty
	PCB	1
Q1	CMPA2060035F, 2.0-6.0GHz, GaN MMIC	1
C1	CAP, 3.9pF, +/-0.1pF, 0402, ATC	1
C2, C9, C10, C15	CAP CER 0.1UF 100V 10% X7R 0805	4
C3, C4, C7, C8	CAP, 100.0pF, +/-5%, 0603, ATC	4
C5, C6	CAP, 10.0pF, +/-5%, 0603, ATC	2
C11, C14	CAP CER 2200PF 100V 10% X7R 0805	2
C12, C13	CAP, 22pF, +/-5%, 0603, ATC	2
C16	CAP 10UF 16V TANTALUM, 2312	1
C17	CAP, 33 UF, 20%, G CASE	1
J1, J2	CONN, SMA, PANEL MOUNT JACK, FLANGE, 4-HOLE, BLUNT POST, 20MIL	2
J3	HEADER RT>PLZ .1CEN LK 5POS	1
J4	CONN, SMB, STRAIGHT JACK RECEPTACLE, SMT, 50 OHM, Au PLATED	1
W1, W2	WIRE, BLACK, 22 AWG	2
	WIRE ASSEMBLY, 5-PIN, MMIC HPA FIXTURES	1
	CLAMP, DELRIN	2
	2-56 SOC HD SCREW 3/16 SS	4
	2-56 SOC HD SCREW 1/2 SS	4
	PREFORM, INDIUM, 2 X 2 X 0.003" THK, WITH 0.0002" THK AL CLAD ON ONE SIDE	1
	TEST FIXTURE INSTRUCTIONS	1



Product Dimensions CPM2060035F (Package Type – 440219)

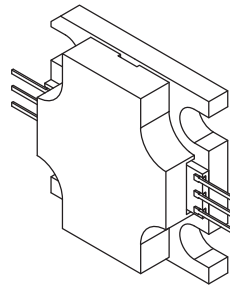
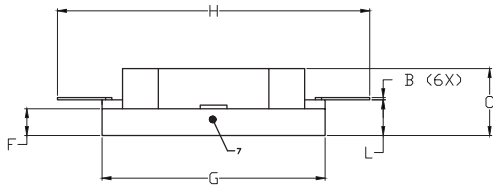
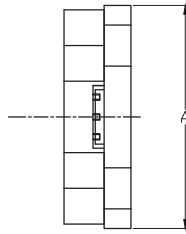
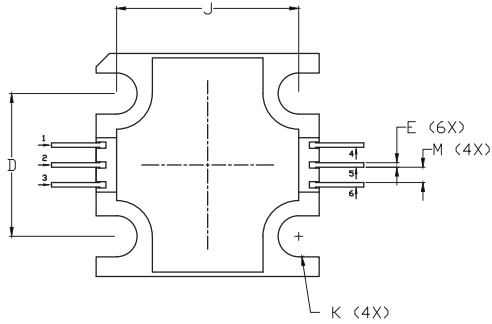

NOT TO SCALE

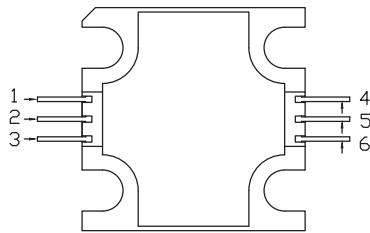

PIN	Function
1	Gate 1
2	RFIN
3	Gate 2
4	Drain 1
5	RFOUT
6	Drain 2
7	Ground

NOTES:

1. DIMENSIONING AND TOLERANCING PER ANSI Y14.5M, 1982.
2. CONTROLLING DIMENSION: INCH.
3. ADHESIVE FROM LID MAY EXTEND A MAXIMUM OF 0.020" BEYOND EDGE OF LID.
4. LID MAY BE MISALIGNED TO THE BODY OF THE PACKAGE BY A MAXIMUM OF 0.008" IN ANY DIRECTION.
5. ALL PLATED SURFACES ARE NI/AU

DIM	INCHES		MILLIMETERS	
	MIN	MAX	MIN	MAX
A	0.495	0.505	12.57	12.82
B	0.003	0.005	0.076	0.127
C	0.140	0.160	3.56	4.06
D	0.315	0.325	8.00	8.25
E	0.008	0.012	0.204	0.304
F	0.055	0.065	1.40	1.65
G	0.495	0.505	12.57	12.82
H	0.695	0.705	17.65	17.91
J	0.403	0.413	10.24	10.49
K	Ø .092		2.34	
L	0.075	0.085	1.905	2.159
M	0.032	0.040	0.82	1.02



Product Ordering Information

Order Number	Description	Unit of Measure	Image
CMPA2060035F	GaN MMIC	Each	
CMPA2060035F-AMP	Test board with GaN MMIC installed	Each	