

CMPA801B030F

30 W, 8.0 – 11.0 GHz, GaN MMIC, Power Amplifiers

Description

Wolfspeed's CMPA801B030F is a gallium nitride (GaN) High Electron Mobility Transistor (HEMT) based monolithic microwave integrated circuit (MMIC). GaN has superior properties compared to silicon or gallium arsenide, including higher breakdown voltage, higher saturated electron drift velocity and higher thermal conductivity. GaN HEMTs also offer greater power density and wider bandwidths compared to Si and GaAs transistors. This MMIC is available in a 10-lead metal/ceramic flanged package for optimal electrical and thermal performance.

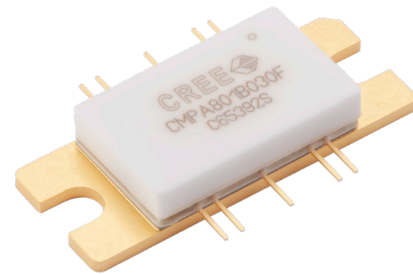

PN : CMPA801B030F
Package Type : 440213

Features

- 8.0 - 11.0 GHz Operation
- 37 W P_{OUT} typical
- 16 dB Power gain
- 36% Typical PAE
- 50 Ohm internally matched

Applications

- Marine Radar
- Communications
- Satellite Communication Uplink

Typical Performance Over 8.0 - 11.0 GHz ($T_c = 85^\circ\text{C}$)

Parameter	8.0 GHz	8.5 GHz	9.0 GHz	10.0 GHz	11.0 GHz	Units
Small Signal Gain	27	25	22	23	21	dB
Output Power ¹	31	30	28	25	24	W
Power Gain ¹	17	17	17	16	16	dB
Power Added Efficiency ¹	39	39	36	28	33	%

Note:

1. Measured in CMPA801B030F-AMP under $P_{IN} = 28\text{ dBm}$, 100 μs pulse width, 10% duty.

Absolute Maximum Ratings (not simultaneous)

Parameter	Symbol	Rating	Units	Conditions
Drain-source Voltage	V_{DSS}	84	V_{DC}	25 °C
Gate-source Voltage	V_{GS}	-10, +2	V_{DC}	25 °C
Power Dissipation	P_{DISS}	77	W	
Storage Temperature	T_{STG}	-55, +150	°C	
Operating Junction Temperature	T_J	225	°C	
Maximum Forward Gate Current	I_{GMAX}	13	mA	25 °C
Soldering Temperature ¹	T_S	245	°C	
Screw Torque	τ	40	in-oz	
Thermal Resistance, Junction to Case	$R_{\theta JC}$	1.22	°C/W	Pulse Width = 100 μ s, Duty Cycle = 10%, $P_{DISS} = 55$ W
Thermal Resistance, Junction to Case	$R_{\theta JC}$	1.80	°C/W	CW, $P_{DISS} = 55$ W, 85 °C
Case Operating Temperature	T_C	-40, +130	°C	Pulse Width = 100 μ s, Duty Cycle = 10%, $P_{DISS} = 55$ W
Case Operating Temperature	T_C	-40, +90	°C	CW, $P_{DISS} = 55$ W

Note:

¹ Refer to the Application Note on soldering at www.wolfspeed.com/RF/Document-Library**Electrical Characteristics** (Frequency = 8.0 GHz - 11.0 GHz unless otherwise stated; $T_C = 25$ °C)

Characteristics	Symbol	Min.	Typ.	Max.	Units	Conditions
DC Characteristics¹						
Gate Threshold	$V_{GS(TH)}$	-3.8	-3.0	-2.3	V	$V_{DS} = 10$ V, $I_D = 13$ mA
Gate Quiescent Voltage	$V_{GS(Q)}$	-	-2.7	-	V	$V_{DS} = 28$ V, $I_D = 800$ mA
Saturated Drain Current ²	I_{DS}	9.5	13.2	-	A	$V_{DS} = 6.0$ V, $V_{GS} = 2.0$ V
Drain-Source Breakdown Voltage	V_{BD}	84	-	-	V	$V_{GS} = -8$ V, $I_D = 13$ mA
RF Characteristics³						
Small Signal Gain	S21	-	23	-	dB	$V_{DD} = 28$ V, $I_{DQ} = 800$ mA, Frequency = 8-11 GHz
Input Return Loss	S11	-	-3.7	-	dB	$V_{DD} = 28$ V, $I_{DQ} = 800$ mA, Frequency = 8-11 GHz
Output Return Loss	S22	-	-3.6	-	dB	$V_{DD} = 28$ V, $I_{DQ} = 800$ mA, Frequency = 8-11 GHz
Output Mismatch Stress	VSWR	-	-	5:1	Ψ	No damage at all phase angles, $V_{DD} = 28$ V, $I_{DQ} = 800$ mA, Pulse Width = 100 μ s, Duty Cycle = 10%, $P_{OUT} = 30$ W

Notes:

¹ Measured on-wafer prior to packaging.² Scaled from PCM data.³ Measured in the CMPA801B030F-AMP.

Electrical Characteristics Continued... (T_c = 25 °C)

Characteristics	Symbol	Min.	Typ.	Max.	Units	Conditions
RF Characteristics^{1,2}						
Output Power	P _{OUT1}	–	45.4	–	dBm	V _{DD} = 28 V, I _{DQ} = 800 mA, Frequency = 8.0 GHz, P _{IN} = 28 dBm
Output Power	P _{OUT2}	–	45.8	–	dBm	V _{DD} = 28 V, I _{DQ} = 800 mA, Frequency = 8.5 GHz, P _{IN} = 28 dBm
Output Power	P _{OUT3}	–	45.9	–	dBm	V _{DD} = 28 V, I _{DQ} = 800 mA, Frequency = 9.0 GHz, P _{IN} = 28 dBm
Output Power	P _{OUT4}	–	45.9	–	dBm	V _{DD} = 28 V, I _{DQ} = 800 mA, Frequency = 10.0 GHz, P _{IN} = 28 dBm
Output Power	P _{OUT5}	–	45.3	–	dBm	V _{DD} = 28 V, I _{DQ} = 800 mA, Frequency = 11.0 GHz, P _{IN} = 28 dBm
Power Gain	G ₁	–	16.5	–	dB	V _{DD} = 28 V, I _{DQ} = 800 mA, Frequency = 8.0 GHz, P _{IN} = 28 dBm
Power Gain	G ₂	–	17.1	–	dB	V _{DD} = 28 V, I _{DQ} = 800 mA, Frequency = 8.5 GHz, P _{IN} = 28 dBm
Power Gain	G ₃	–	16.4	–	dB	V _{DD} = 28 V, I _{DQ} = 800 mA, Frequency = 9.0 GHz, P _{IN} = 28 dBm
Power Gain	G ₄	–	15.8	–	dB	V _{DD} = 28 V, I _{DQ} = 800 mA, Frequency = 10.0 GHz, P _{IN} = 28 dBm
Power Gain	G ₅	–	16.9	–	dB	V _{DD} = 28 V, I _{DQ} = 800 mA, Frequency = 11.0 GHz, P _{IN} = 28 dBm
Power Added Efficiency	PAE ₁	–	40.5	–	%	V _{DD} = 28 V, I _{DQ} = 800 mA, Frequency = 8.0 GHz, P _{IN} = 28 dBm
Power Added Efficiency	PAE ₂	–	45.3	–	%	V _{DD} = 28 V, I _{DQ} = 800 mA, Frequency = 8.5 GHz, P _{IN} = 28 dBm
Power Added Efficiency	PAE ₃	–	41.7	–	%	V _{DD} = 28 V, I _{DQ} = 800 mA, Frequency = 9.0 GHz, P _{IN} = 28 dBm
Power Added Efficiency	PAE ₄	–	36.0	–	%	V _{DD} = 28 V, I _{DQ} = 800 mA, Frequency = 10.0 GHz, P _{IN} = 28 dBm
Power Added Efficiency	PAE ₅	–	39.8	–	%	V _{DD} = 28 V, I _{DQ} = 800 mA, Frequency = 11.0 GHz, P _{IN} = 28 dBm
Pulse Amplitude Droop	D	–	0.1	–	dB	V _{DD} = 28 V, I _{DQ} = 800 mA, Frequency = 8.5 - 11.0 GHz, P _{IN} = 28 dBm

Notes:

¹ Pulse Width = 100 μs, Duty Cycle = 10 %.² Measured in CMPA801B030F-AMP.**Electrostatic Discharge (ESD) Classifications**

Parameter	Symbol	Class	Test Methodology
Human Body Model	HBM	1A (> 250 V)	JEDEC JESD22 A114-D
Charge Device Model	CDM	II (200 V < 500 V)	JEDEC JESD22 C101-C

Typical Performance

Figure 1. - Small Signal Gain and Return Loss vs. Frequency of the CMPA801B030F as Measured in Circuit CMPA801B030F-AMP Demonstration Amplifier
 $V_{DD} = 28\text{ V}, I_{DQ} = 800\text{ mA}$

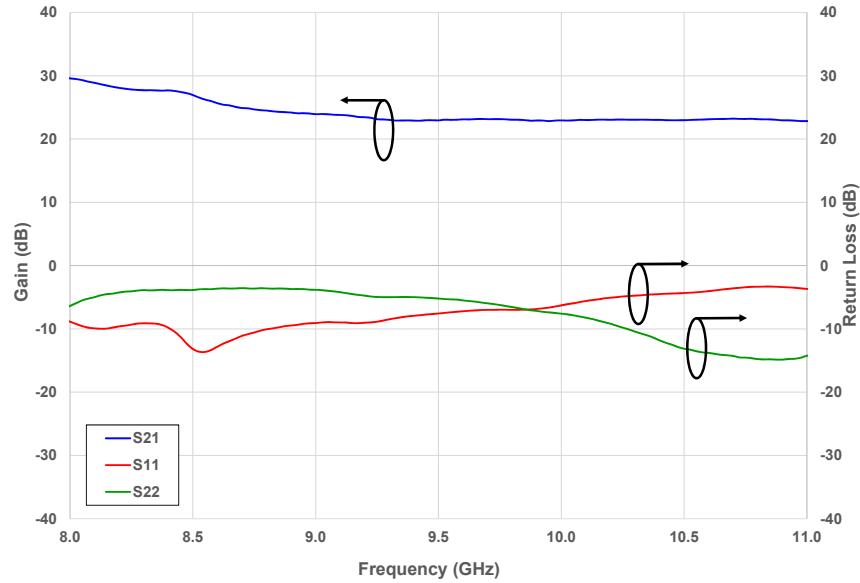
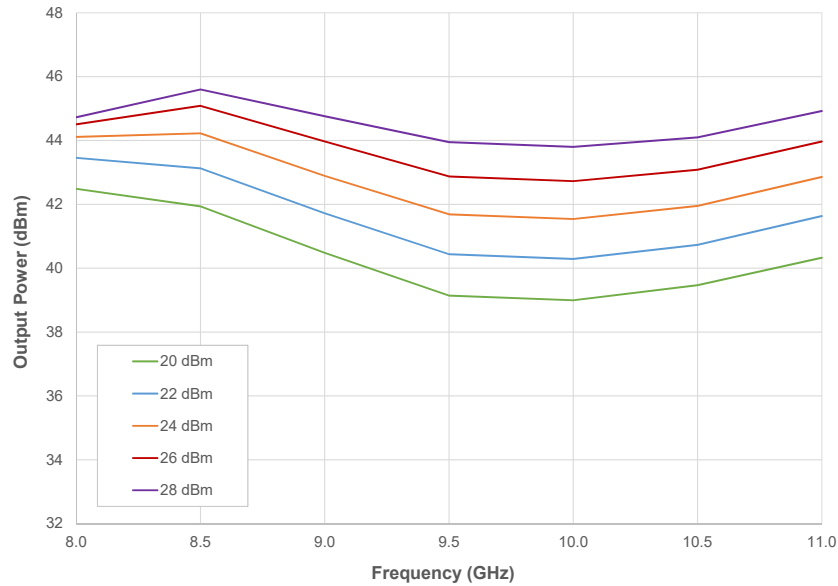

Figure 2. - CW Output Power vs Frequency as a Function of Input Power of the CMPA801B030F as Measured in Demonstration Amplifier Circuit CMPA801B030F-AMP
 $V_{DD} = 28\text{ V}, I_{DQ} = 800\text{ mA}$



Typical Performance

Figure 3. - CW Gain vs Frequency as a Function of Input Power of the CMPA801B030F as Measured in Demonstration Amplifier Circuit CMPA801B030F-AMP
 $V_{DD} = 28\text{ V}, I_{DQ} = 800\text{ mA}$

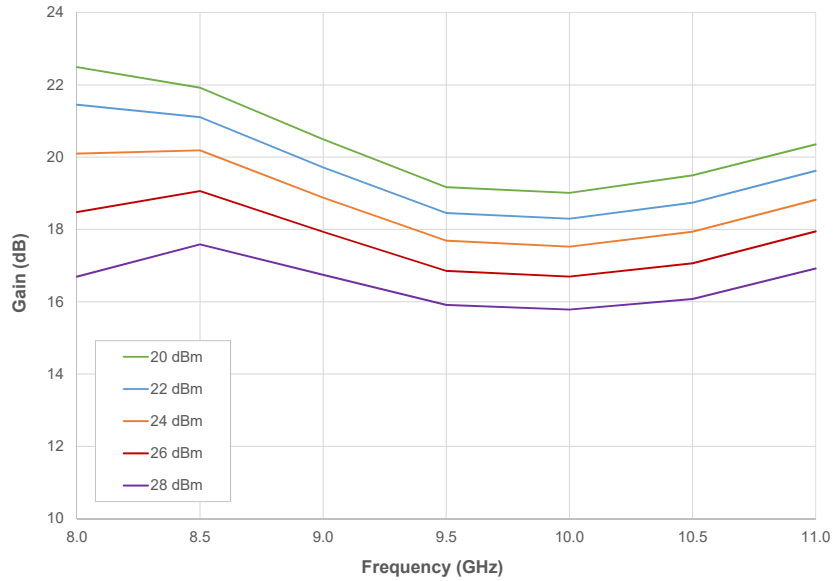
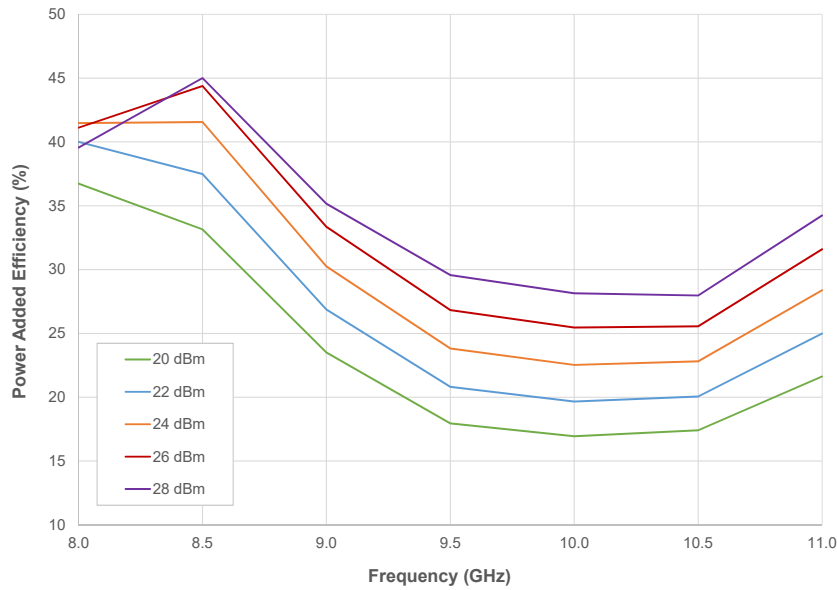

Figure 4. - CW Power Added Efficiency vs Frequency as a Function of Input Power of the CMPA801B030F as Measured in Demonstration Amplifier Circuit CMPA801B030F-AMP
 $V_{DD} = 28\text{ V}, I_{DQ} = 800\text{ mA}$



Typical Performance

Figure 5. - Pulsed Output Power vs Frequency as a Function of Input Power of the CMPA801B030F as Measured in Demonstration Amplifier Circuit CMPA801B030F-AMP

$V_{DD} = 28\text{ V}$, $I_{DQ} = 800\text{ mA}$, Pulse Width = 100 μs , Duty Cycle = 10%

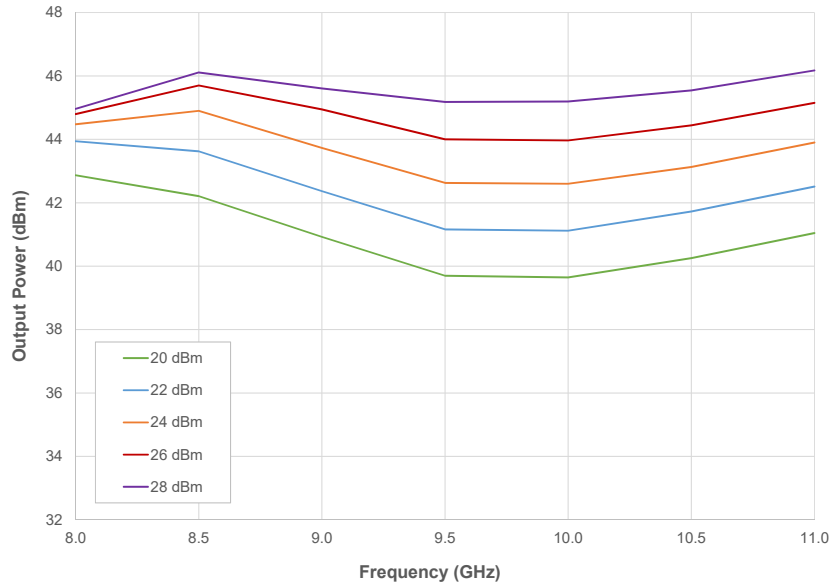
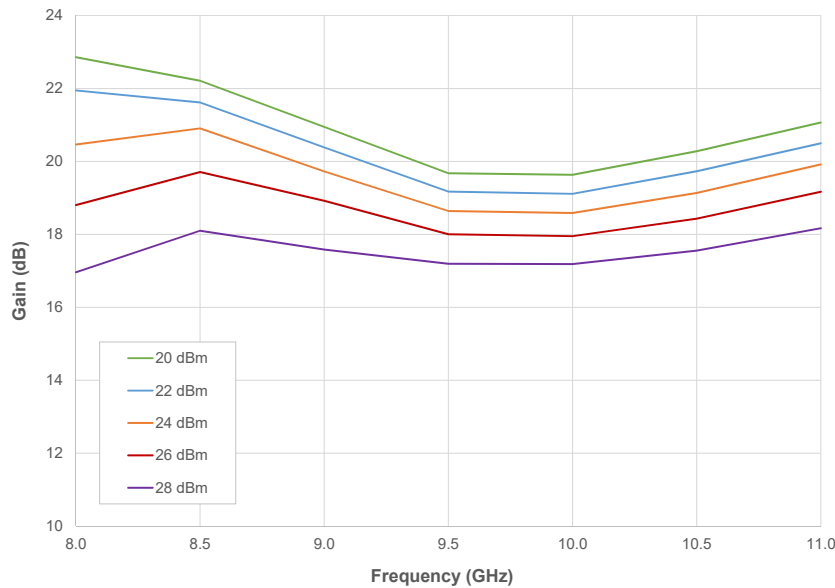

Figure 6. - Pulsed Gain vs Frequency as a Function of Input Power of the CMPA801B030F as Measured in Demonstration Amplifier Circuit CMPA801B030F-AMP

$V_{DD} = 28\text{ V}$, $I_{DQ} = 800\text{ mA}$, Pulse Width = 100 μs , Duty Cycle = 10%



Typical Performance

Figure 7. - Pulsed Power Added Efficiency vs Frequency as a Function of Input Power of the CMPA801B030F as Measured in Demonstration Amplifier Circuit CMPA801B030F-AMP

$V_{DD} = 28\text{ V}$, $I_{DQ} = 800\text{ mA}$, Pulse Width = 100 μs , Duty Cycle = 10%

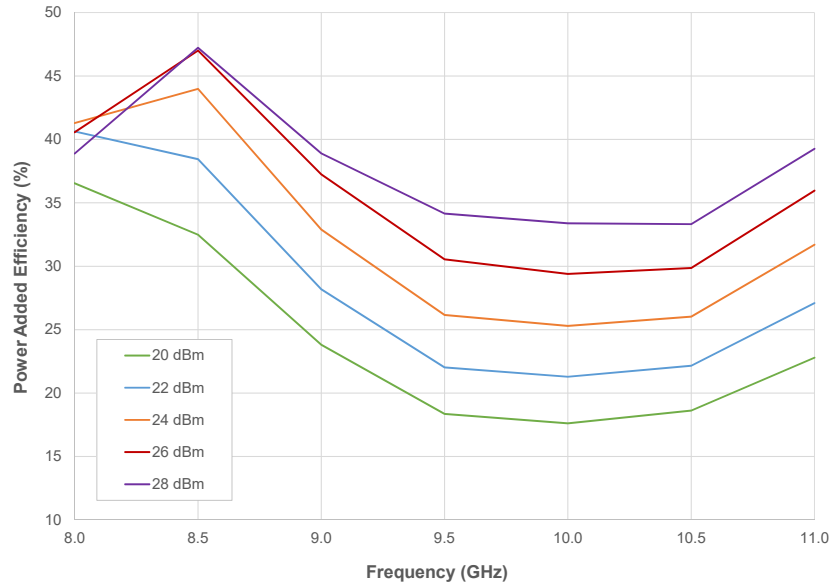
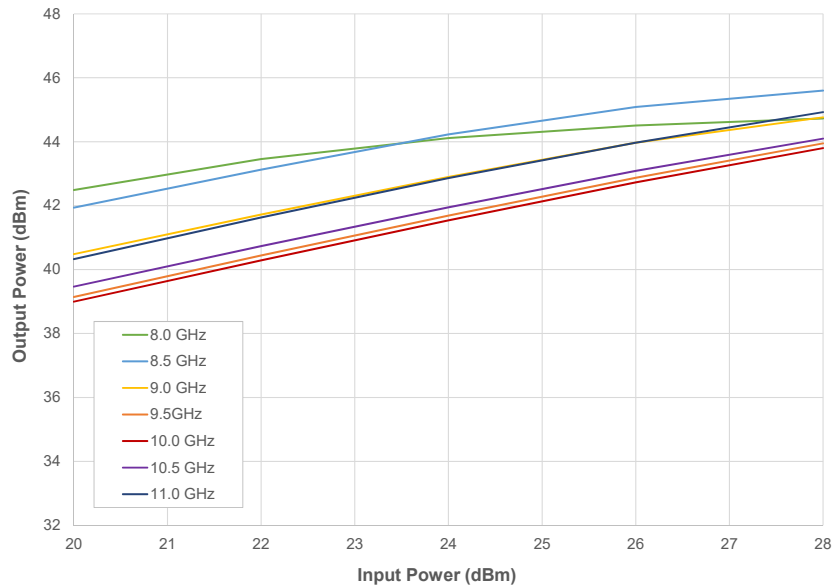

Figure 8. - CW Output Power vs Input Power as a Function of Frequency of the CMPA801B030F as Measured in Demonstration Amplifier Circuit CMPA801B030F-AMP

$V_{DD} = 28\text{ V}$, $I_{DQ} = 800\text{ mA}$



Typical Performance

Figure 9. - CW Gain vs Input Power as a Function of Frequency of the CMPA801B030F as Measured in Demonstration Amplifier Circuit CMPA801B030F-AMP

$V_{DD} = 28\text{ V}$, $I_{DQ} = 800\text{ mA}$

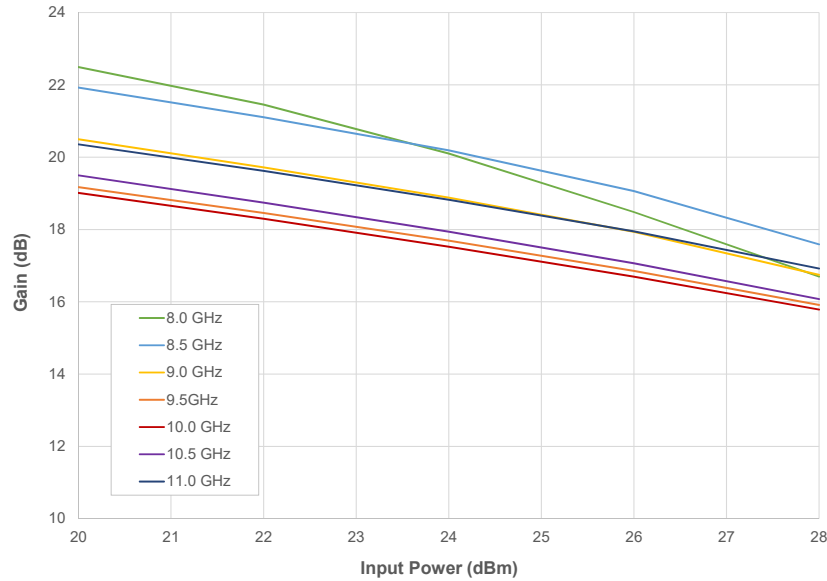
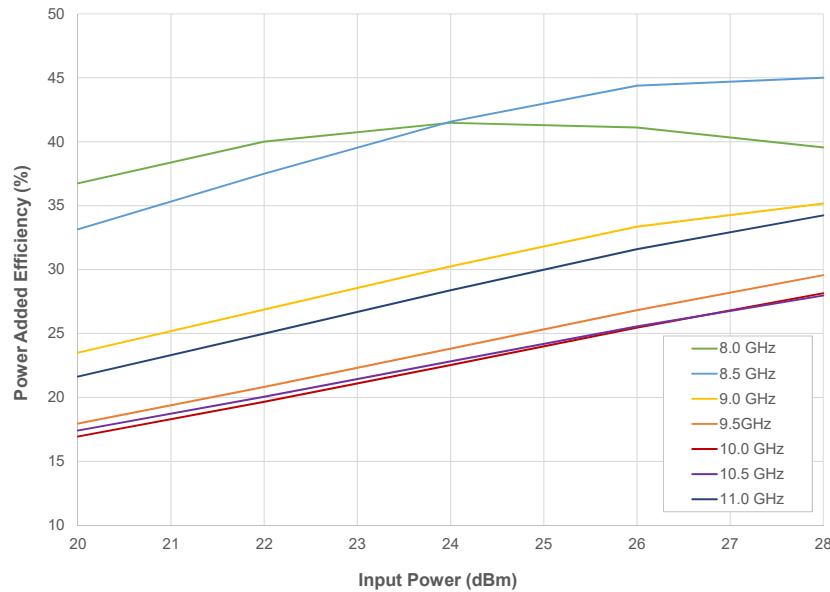

Figure 10. - CW Power Added Efficiency vs Input Power as a Function of Frequency of the CMPA801B030F as Measured in Demonstration Amplifier Circuit CMPA801B030F-AMP

$V_{DD} = 28\text{ V}$, $I_{DQ} = 800\text{ mA}$



Typical Performance

Figure 11. - Pulsed Output Power vs Input Power as a Function of Frequency of the CMPA801B030F as Measured in Demonstration Amplifier Circuit CMPA801B030F-AMP

$V_{DD} = 28\text{ V}$, $I_{DQ} = 800\text{ mA}$, Pulse Width = 100 μs , Duty Cycle = 10%

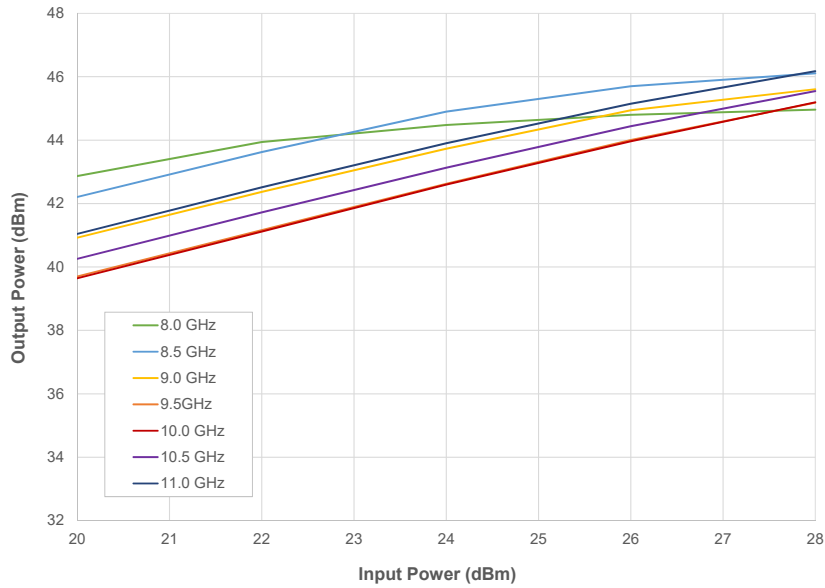
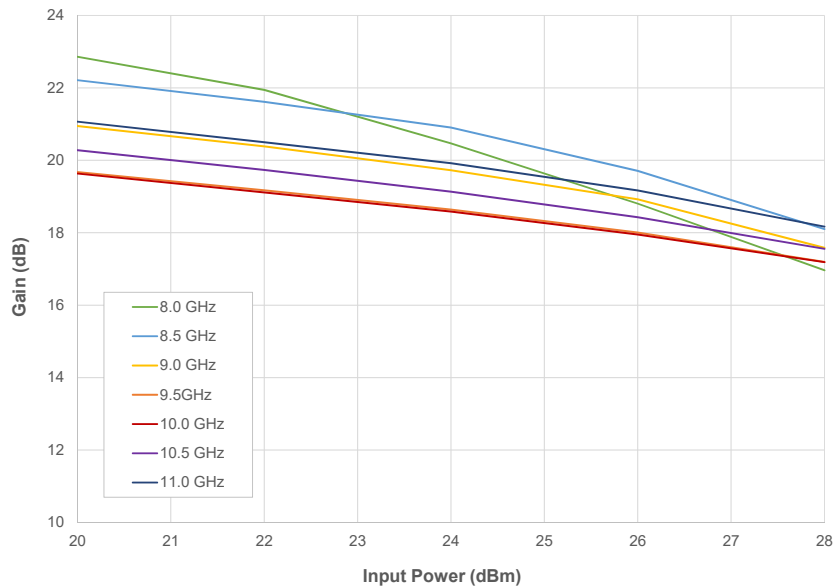

Figure 12. - Pulsed Gain vs Input Power as a Function of Frequency of the CMPA801B030F as Measured in Demonstration Amplifier Circuit CMPA801B030F-AMP

$V_{DD} = 28\text{ V}$, $I_{DQ} = 800\text{ mA}$, Pulse Width = 100 μs , Duty Cycle = 10%



Typical Performance

Figure 13. - Pulsed Power Added Efficiency vs Input Power as a Function of Frequency of the CMPA801B030F as Measured in Demonstration Amplifier Circuit CMPA801B030F-AMP

$V_{DD} = 28\text{ V}$, $I_{DQ} = 800\text{ mA}$, Pulse Width = 100 μs , Duty Cycle = 10%

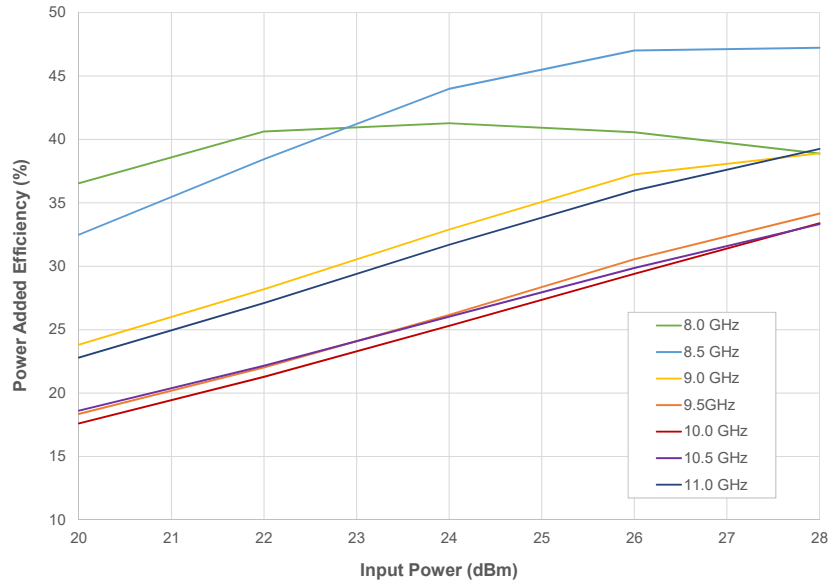

CMPA801B030F-AMP Demonstration Amplifier Circuit Bill of Materials

Designator	Description	Qty
C15	CAP ELECT 100UF 80V AFK SMD	1
C16-C23	CAP,33000PF, 0805,100V, X7R	8
R1, R2	RES 0.0 OHM 1/16W 0402 SMD	2
J1, J2	CONN, SMA, PANEL MOUNT JACK, FLANGE, 4-HOLE, BLUNT POST, 20MIL	2
J4	CONN, SMB, STRAIGHT JACK RECEPTACLE, SMT, 50 OHM, Au PLATED	1
J3	HEADER RT>PLZ .1CEN LK 9POS	1
W1	WIRE, BLACK, 22 AWG ~ 1.50"	1
W2	WIRE, BLACK, 22 AWG ~ 1.75"	1
W3	WIRE, BLACK, 22 AWG ~ 3.0"	1
-	PCB, TEST FIXTURE, TACONICS RF35P, 20 MILS, 440208 PKG	1
-	2-56 SOC HD SCREW 3/16 SS	4
-	#2 SPLIT LOCKWASHER SS	4
Q1	Transistor CMPA801B030F	1

CMPA801B030F-AMP Demonstration Amplifier Circuit

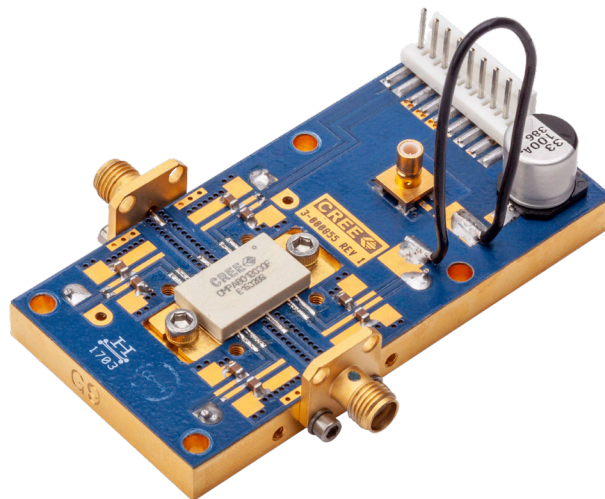

CMPA801B030F-AMP Demonstration Amplifier Circuit Outline

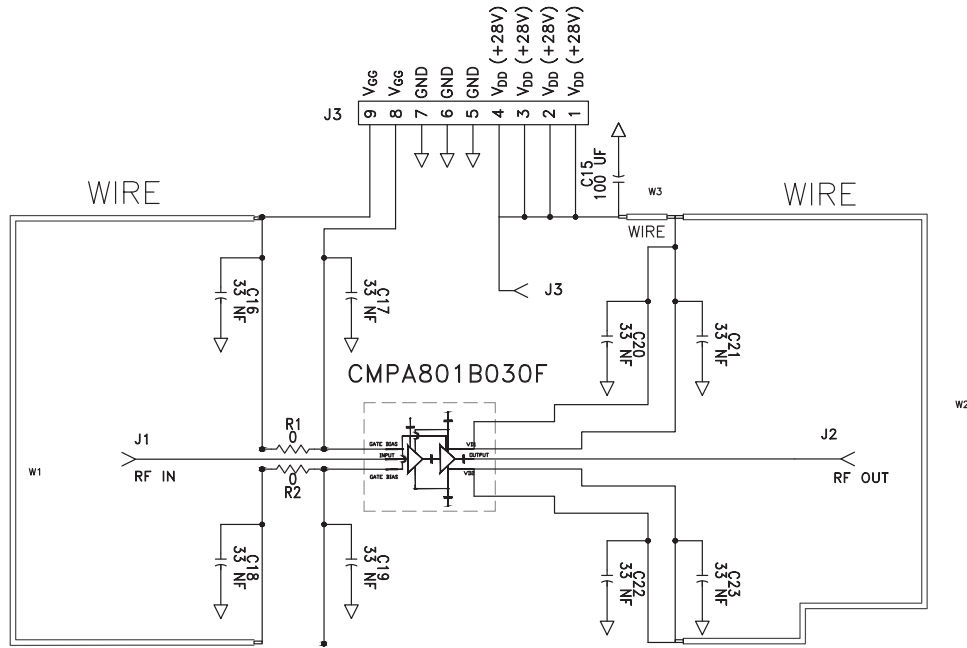

CMPA801B030F-AMP Demonstration Amplifier Circuit Outline

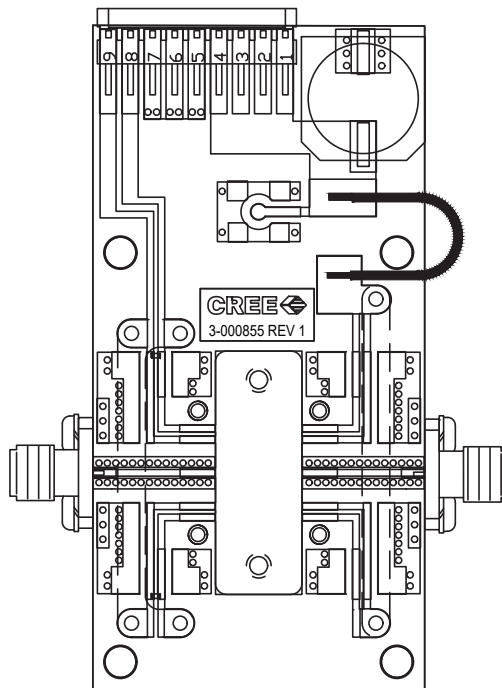

CMPA801B030F-AMP Demonstration Amplifier Circuit Schematic

To configure the CMPA801B030F test fixture to enable independent V_{G1} / V_{G2} control of the device, a cut must be made to the microstrip line just above the R1 resistor as shown. Pin 9 will then supply V_{G1} and Pin 8 will supply V_{G2} .

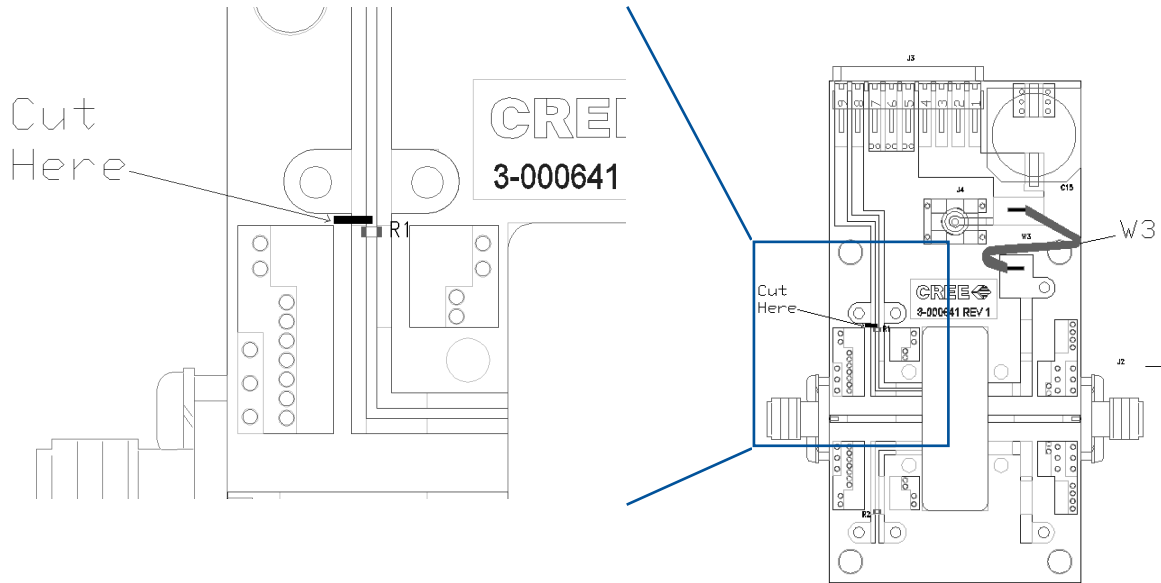

Product Dimensions CPMA801B030F (Package Type – 440213)

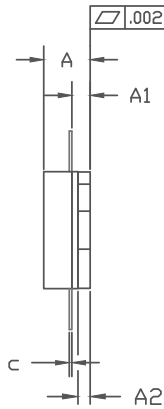
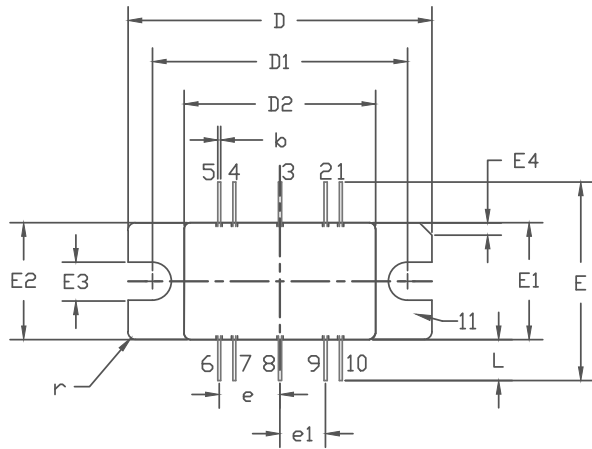

PIN 1: GATE BIAS 6: DRAIN BIAS
 2: GATE BIAS 7: DRAIN BIAS
 3: RF IN 8: RF OUT
 4: GATE BIAS 9: DRAIN BIAS
 5: GATE BIAS 10: DRAIN BIAS
 11: SOURCE

NOTES:

1. DIMENSIONING AND TOLERANCING PER ANSI Y14.5M - 1994.
2. CONTROLLING DIMENSION: INCH.
3. ADHESIVE FROM LID MAY EXTEND A MAXIMUM OF 0.020" BEYOND EDGE OF LID.
4. LID MAY BE MISALIGNED TO THE BODY OF PACKAGE BY A MAXIMUM OF 0.008" IN ANY DIRECTION.

DIM	INCHES		MILLIMETERS		NOTES
	MIN	MAX	MIN	MAX	
A	0.148	0.168	3.76	4.27	
A1	0.055	0.065	1.40	1.65	
A2	0.035	0.045	0.89	1.14	
b	0.01 TYP		0.254 TYP		10x
c	0.007	0.009	0.18	0.23	
D	0.995	1.005	25.27	25.53	
D1	0.835	0.845	21.21	21.46	
D2	0.623	0.637	15.82	16.18	
E	0.653 TYP		16.59 TYP		
E1	0.380	0.390	9.65	9.91	
E2	0.380	0.390	9.65	9.91	
E3	0.120	0.130	3.05	3.30	
E4	0.035	0.045	0.89	1.14	45° CHAMFER
e	0.200 TYP		5.08 TYP		4x
e1	0.150 TYP		3.81 TYP		4x
L	0.115	0.155	2.92	3.94	10x
r	0.025 TYP		.635 TYP		3x

Pin Number	Qty
1	Gate Bias for Stage 2
2	Gate Bias for Stage 2
3	RF In
4	Gate Bias for Stage 1
5	Gate Bias for Stage 1
6	Drain Bias
7	Drain Bias
8	RF Out
9	Drain Bias
10	Drain Bias
11	Source

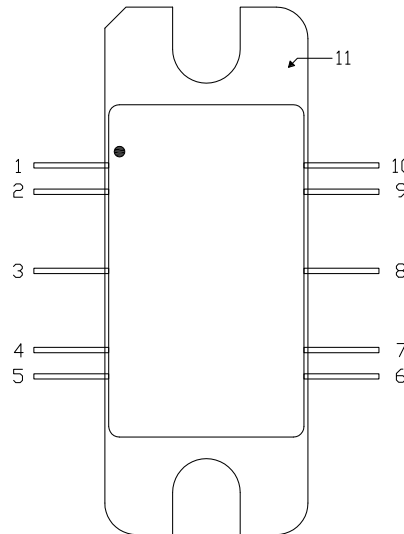

Part Number System

CMPA801B030F

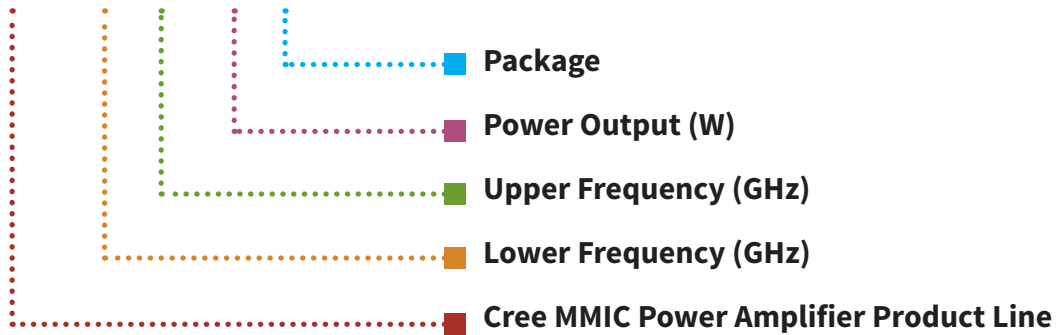

Parameter	Value	Units
Lower Frequency	8.0	GHz
Upper Frequency ¹	11.0	GHz
Power Output	30	W
Package	Flange	-

Table 1.

Note¹: Alpha characters used in frequency code indicate a value greater than 9.9 GHz. See Table 2 for value.

Character Code	Code Value
A	0
B	1
C	2
D	3
E	4
F	5
G	6
H	7
J	8
K	9
Examples:	1A = 10.0 GHz 2H = 27.0 GHz

Table 2.

Product Ordering Information

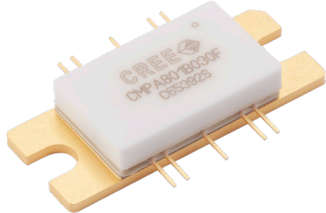
Order Number	Description	Unit of Measure	Image
CMPA801B030F	GaN HEMT	Each	
CMPA801B030F-AMP	Test board with GaN HEMT installed	Each	