

CMSN3416K-HF

**N-Channel
RoHS Device
Halogen Free**

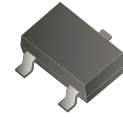

Features

- V_{DS} 20V
- I_D 7.0A
- R_{DS(ON)} (at V_{GS}=4.5V) <18 mohm
- R_{DS(ON)} (at V_{GS}=2.5V) <22 mohm
- R_{DS(ON)} (at V_{GS}=1.8V) <39 mohm
- ESD protected up to 3.5KV (HBM)

Mechanical data

- Case: SOT-23, molded plastic.

Circuit Diagram

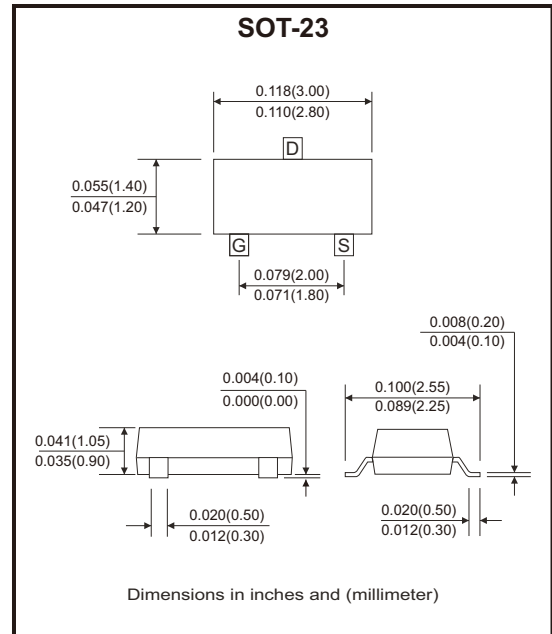
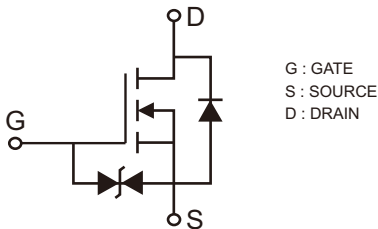

Maximum Ratings (at T_a=25°C unless otherwise noted)

Parameter	Symbol	Value	Unit
Drain-source voltage	V _{DS}	20	V
Gate-source voltage	V _{GS}	±12	V
Drain current	I _D	T _A =25°C @ steady state	7.0
		T _A =70°C @ steady state	5.6
Pulsed drain current (Note 1)	I _{DM}	30	A
Total power dissipation @ T _A =25°C	P _D	1.3	W
Thermal resistance junction to ambient @ steady state	R _{θJA}	96	°C/W
Junction and storage temperature range	T _J , T _{STG}	-55 to +150	°C

Electrical Characteristics (at $T_J=25^{\circ}\text{C}$ unless otherwise noted)

Parameter	Symbol	Conditions	Min	Typ	Max	Unit
Static Parameters						
Drain-source breakdown voltage	BV_{DSS}	$V_{GS}=0V, I_D=250\mu A$	20			V
Zero gate voltage drain current	I_{DSS}	$V_{DS}=20V, V_{GS}=0V$			1	μA
Gate-body leakage current	I_{GSS}	$V_{GS}=\pm 10V, V_{DS}=0V$		2.5	± 10	μA
		$V_{GS}=\pm 5V, V_{DS}=0V$		300	± 1000	nA
Gate threshold voltage	$V_{GS(th)}$	$V_{DS}=V_{GS}, I_D=250\mu A$	0.45	0.62	1.0	V
Static drain-source on-resistance	$R_{DS(on)}$	$V_{GS}=4.5V, I_D=7A$		13	18	m Ω
		$V_{GS}=2.5V, I_D=4A$		17	22	
		$V_{GS}=1.8V, I_D=3A$		27	39	
Diode forward voltage	V_{SD}	$I_S=7A, V_{GS}=0V$			1.2	V
Max. body-diode continuous current	I_S				7.0	A
Dynamic Parameters						
Input capacitance	C_{iss}	$V_{DS}=10V, V_{GS}=0V, f=1\text{MHz}$		980		pF
Output capacitance	C_{oss}			225		
Reverse transfer capacitance	C_{rss}			120		
Switching Parameters						
Total gate charge	Q_g	$V_{GS}=4.5V, V_{DS}=10V, I_D=7A$		8.1		nC
Gate-source charge	Q_{gs}			2.4		
Gate-drain charge	Q_{gd}			3		
Turn-on delay time	$t_d(on)$	$V_{GS}=4.5V, V_{DD}=10V$ $R_L=1.5\Omega, R_{GEN}=3\Omega$		1.2		ns
Turn-on rise time	t_r			2.4		
Turn-off delay time	$t_d(off)$			22		
Turn-off fall time	t_f			7		

Notes: 1. Pulse width $\leq 300\mu s$, duty cycle $\leq 2\%$.
 2. Device mounted on FR-4 PCB, 1 inch x 0.85 inch x 0.062 inch.

Rating and Characteristic Curves (CMSN3416K-HF)

Fig.1 - Output Characteristics

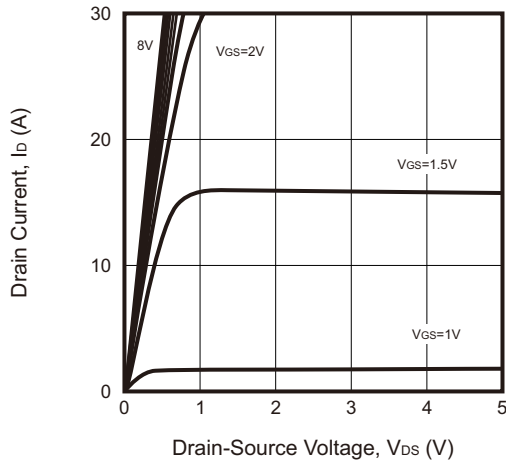

Fig.2 - Transfer Characteristics

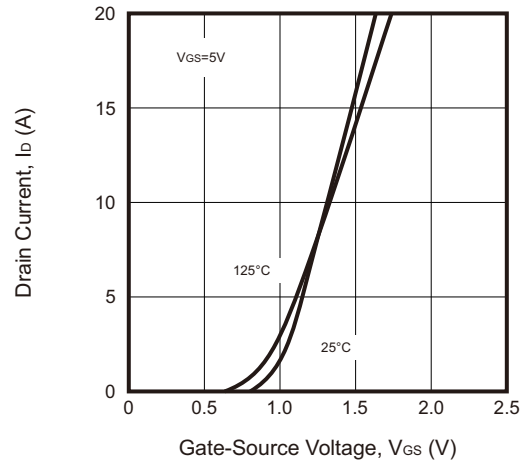

Fig.3 - Capacitance Characteristics

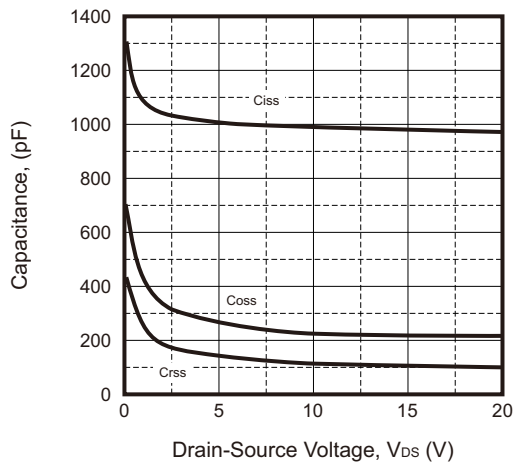

Fig.4 - Gate Charge

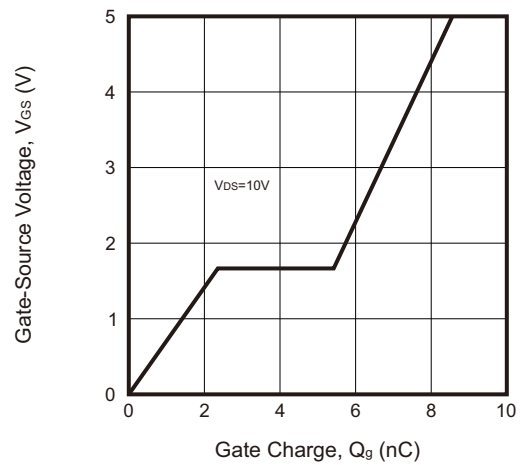

Fig.5 - Drain-Source on Resistance

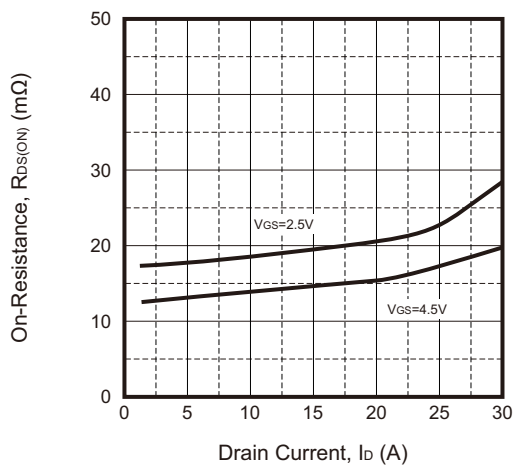
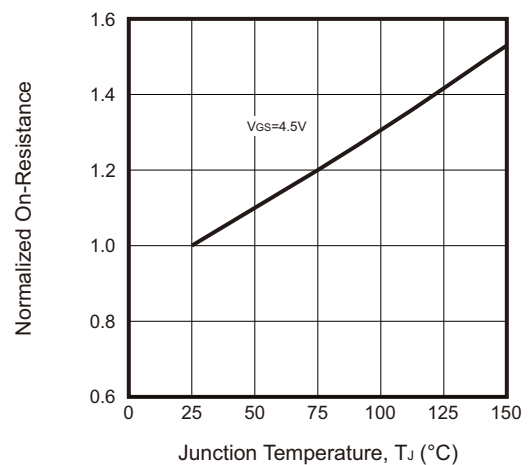

Fig.6 - Drain-Source on Resistance



Company reserves the right to improve product design, functions and reliability without notice.

REV:A

Rating and Characteristic Curves (CMSN3416K-HF)

Fig.7 - Safe Operation Area

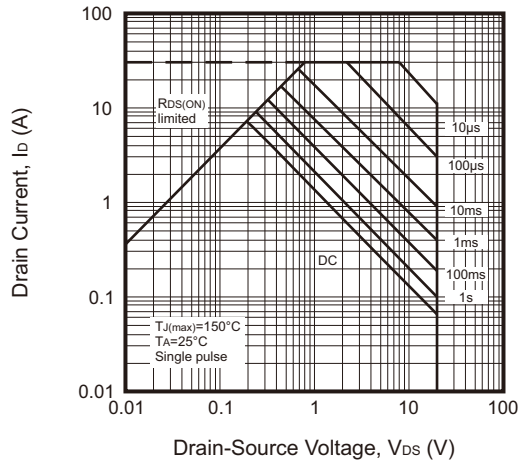

Reel Taping Specification

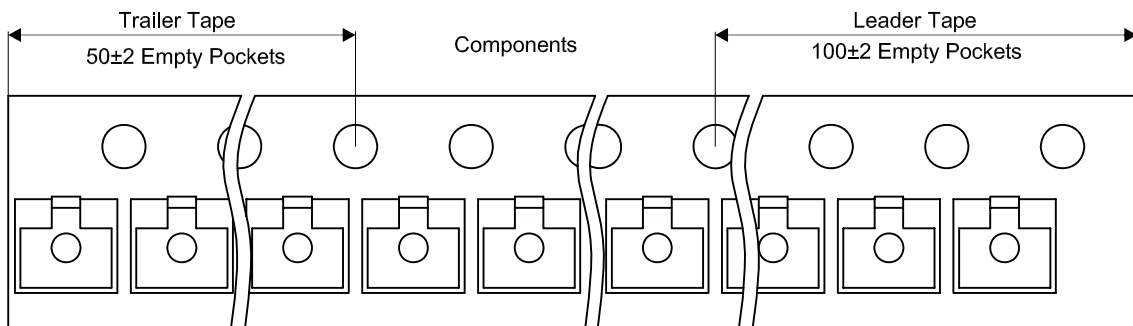
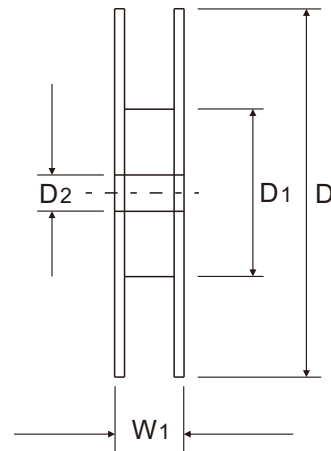
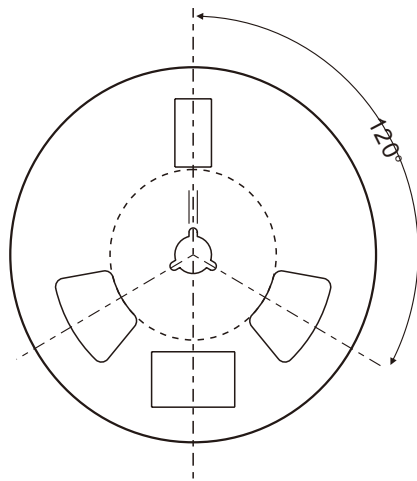
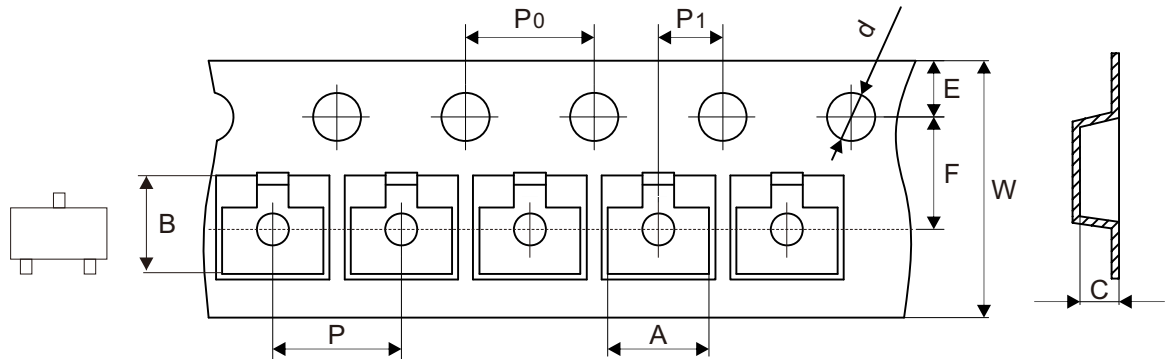

SOT-23	SYMBOL	A	B	C	d	D	D1	D2
	(mm)	3.15 ± 0.10	2.77 ± 0.10	1.22 ± 0.10	1.50 + 0.10 - 0.00	178.00 ± 1.00	54.60 ± 1.00	13.00 ± 1.00
	(inch)	0.124 ± 0.004	0.109 ± 0.004	0.048 ± 0.004	0.059 + 0.004 - 0.000	7.008 ± 0.039	2.150 ± 0.039	0.512 ± 0.039

SOT-23	SYMBOL	E	F	P	P0	P1	W	W1
	(mm)	1.75 ± 0.10	3.50 ± 0.05	4.00 ± 0.10	4.00 ± 0.10	2.00 ± 0.05	8.00 + 0.30 - 0.10	11.10 ± 0.20
	(inch)	0.069 ± 0.004	0.138 ± 0.002	0.157 ± 0.004	0.157 ± 0.004	0.079 ± 0.002	0.315 + 0.012 - 0.004	0.437 ± 0.008

Company reserves the right to improve product design , functions and reliability without notice.

REV:A