

LOS-RS

~9.6° spot beam optimized for Osram Oslon Square EC. 14.3 mm high assembly.

TECHNICAL SPECIFICATIONS:

Dimensions	Ø 21.6 mm
Height	14.3 mm
Fastening	glue, pin
ROHS compliant	yes ⓘ

MATERIAL SPECIFICATIONS:

Component	Type	Material	Colour	Finish
LXP2-RS	Single lens	PMMA	clear	
LEILA-HLD-OSL	Holder	PC	white	



ORDERING INFORMATION:

Component	Type	Qty in box	MOQ	MPQ	Box weight (kg)
CP12412_LOS-RS	Single lens	1680	336	112	9.1
» Box size: 480 x 280 x 300 mm					

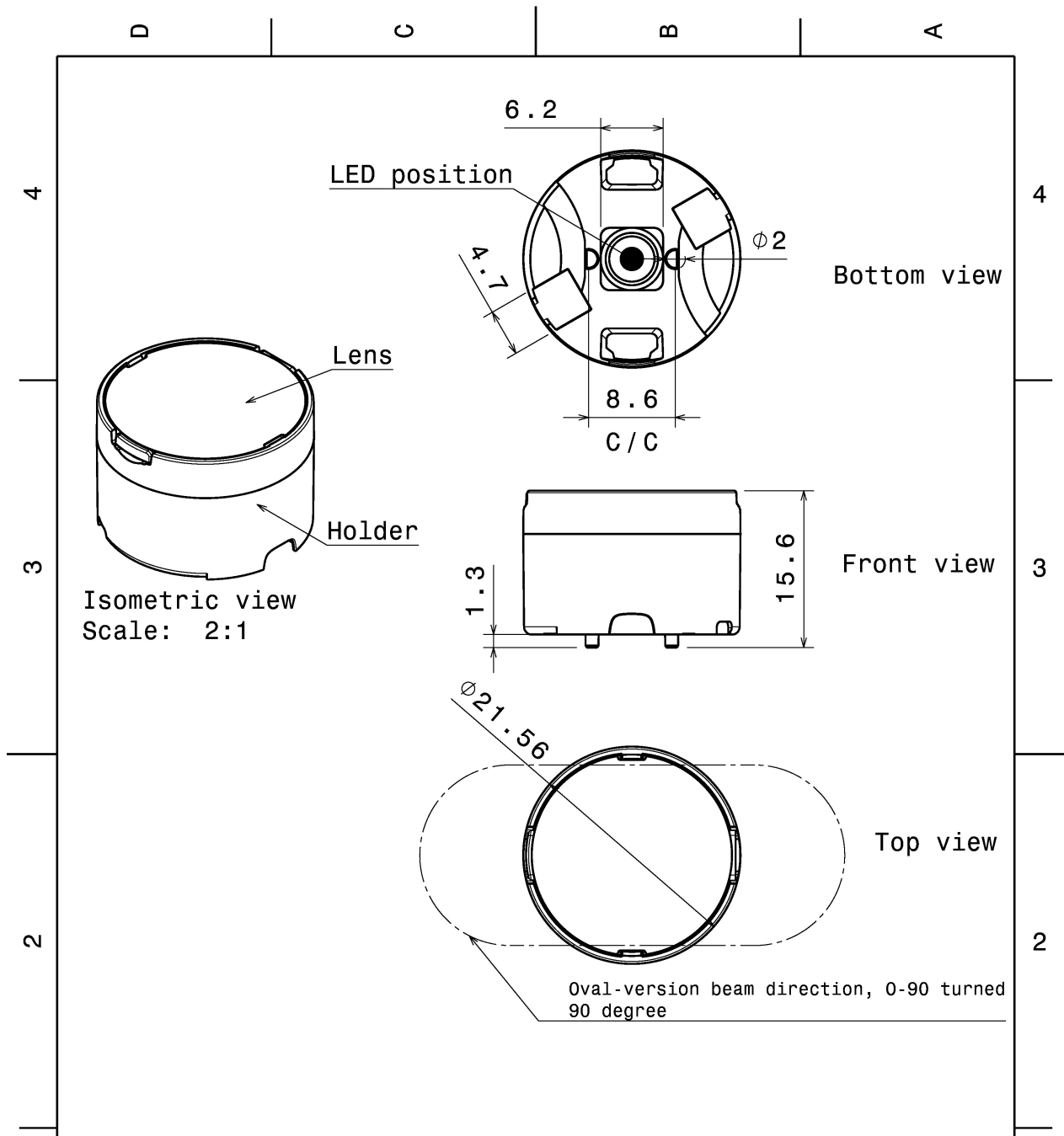

Tolerances if not otherwise shown
According to DIN ISO 2768-1
Linear measures:
Up to 30mm class M, otherwise class C.
According to DIN ISO 2768-2
Form and position: class L

LEDiL Ledil Oy
Salorankatu 10
FIN 24240 SALO
Finland

THIRD ANGLE PROJECTION:

DRAWING TITLE
CP12412_LOS-RS

This drawing is the property of LEDiL Oy. It may not be reproduced, copied or communicated without a written agreement with LEDiL Oy."

SIZE	PART NUMBER
A4	CP12412

SCALE	2:1	WEIGHT	-	SHEET	1/1
-------	-----	--------	---	-------	-----

See also our general installation guide: www.ledil.com/installation_guide

PHOTOMETRIC DATA (MEASURED):

OSRAM

Opto Semiconductors

LED OSLON Square EC
 FWHM / FWTM 10.0° / 20.0°
 Efficiency 94 %
 Peak intensity 20.9 cd/lm
 LEDs/each optic 1
 Light colour White
 Required components:

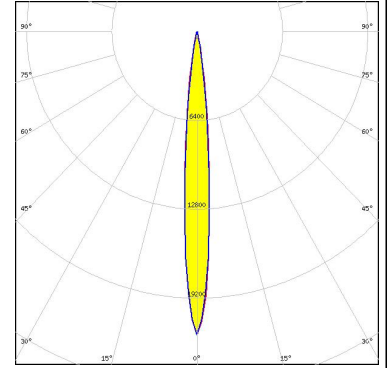

OSRAM

Opto Semiconductors

LED OSLON SSL 150
 FWHM / FWTM 6.0° / 15.0°
 Efficiency 93 %
 Peak intensity 40 cd/lm
 LEDs/each optic 1
 Light colour White
 Required components:

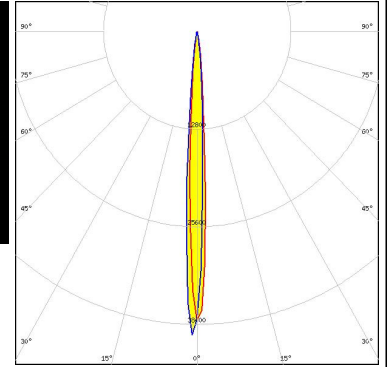
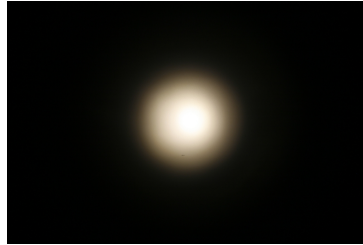

OSRAM

Opto Semiconductors

LED OSLON SSL 80
 FWHM / FWTM 7.0° / 14.0°
 Efficiency 93 %
 Peak intensity 29.8 cd/lm
 LEDs/each optic 1
 Light colour White
 Required components:

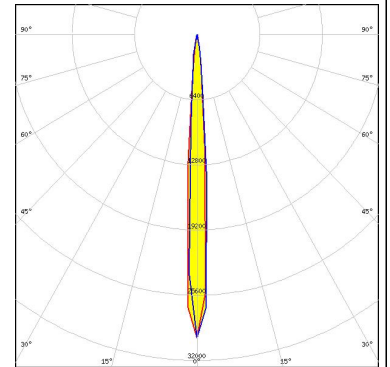

PHOTOMETRIC DATA (SIMULATED):



LED XT-E
 FWHM / FWTM 9.9° / 22.0°
 Efficiency 94 %
 Peak intensity 19.5 cd/lm
 LEDs/each optic 1
 Light colour White
 Required components:

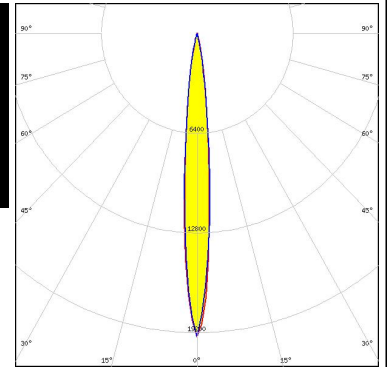

LED LUXEON C
 FWHM / FWTM 8.0° / 20.0°
 Efficiency 94 %
 Peak intensity 22.9 cd/lm
 LEDs/each optic 1
 Light colour White
 Required components:

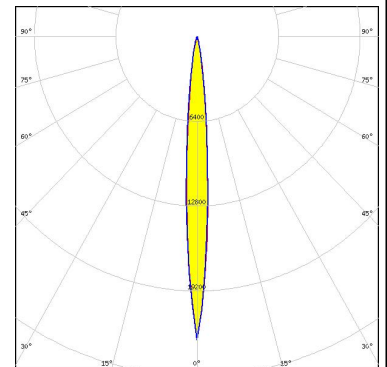

LED OSRAM Opto Semiconductors
 OSLON Square CSSRM2/CSSRM3
 FWHM / FWTM 9.8° / 20.0°
 Efficiency 94 %
 Peak intensity 21.9 cd/lm
 LEDs/each optic 1
 Light colour White
 Required components:

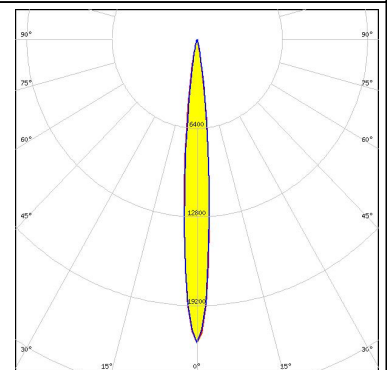

LED LH351B
 FWHM / FWTM 12.0° / 25.0°
 Efficiency 94 %
 Peak intensity 15 cd/lm
 LEDs/each optic 1
 Light colour White
 Required components:

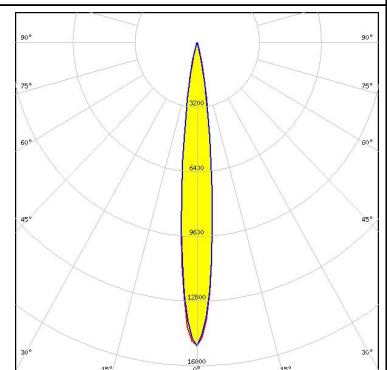

PHOTOMETRIC DATA (SIMULATED):

