

## CARMEN-S-B

~14° spot beam. Assembly with holder B compatible with Ø40 mm BJB and B+W connectors.

### SPECIFICATION:

Dimensions	Ø 69.5 mm
Height	36.3 mm
Fastening	socket
ROHS compliant	yes ⓘ



### MATERIALS:

Component	Type	Material	Colour	Finish
CARMEN-S	Single lens	PMMA	clear	
CARMEN-HLD-B	Holder	PC	black	

### ORDERING INFORMATION:

Component	Type	Qty in box	MOQ	MPQ	Box weight (kg)
CP15212_CARMEN-S-B	Single lens	150	150	15	6.1
» Box size: 476 x 273 x 292 mm					

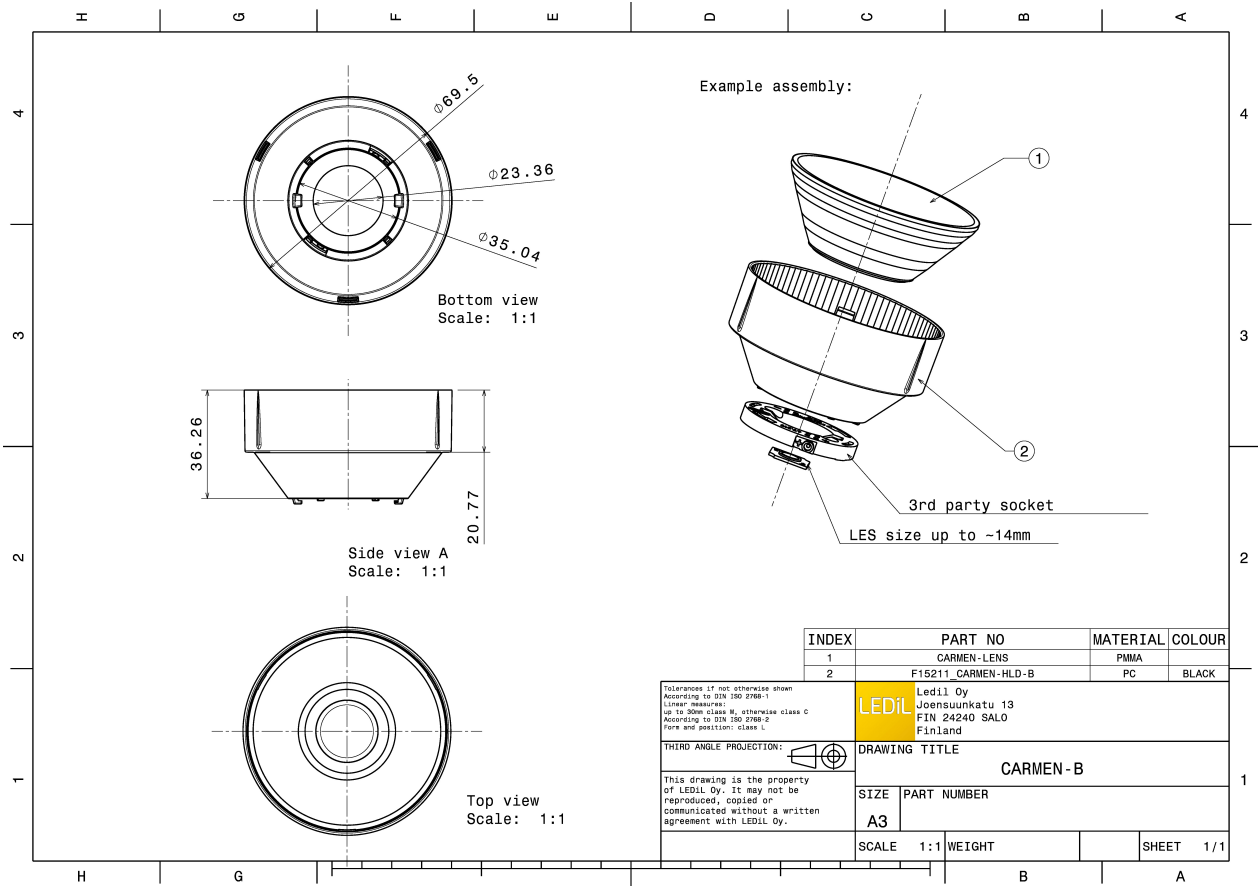

See also our general installation guide: [www.ledil.com/installation\\_guide](http://www.ledil.com/installation_guide)

### OPTICAL RESULTS (MEASURED):

**bridgelux**

LED	V10 Gen7
FWHM / FWTM	14.0° / 34.0°
Efficiency	74 %
Peak intensity	6.5 cd/lm
LEDs/each optic	1
Light colour	White

Required components:  
BJB: 47.319.6060



**CITIZEN**

LED	CLU700/701/702/703
FWHM / FWTM	10.0° / 25.0°
Efficiency	77 %
Peak intensity	12 cd/lm
LEDs/each optic	1
Light colour	White

Required components:  
BJB: 47.319.6060



**CREE LEDs**

LED	CXA/B 13xx
FWHM / FWTM	9.0° / 24.0°
Efficiency	81 %
Peak intensity	13 cd/lm
LEDs/each optic	1
Light colour	White

Required components:  
BJB: 47.319.6120

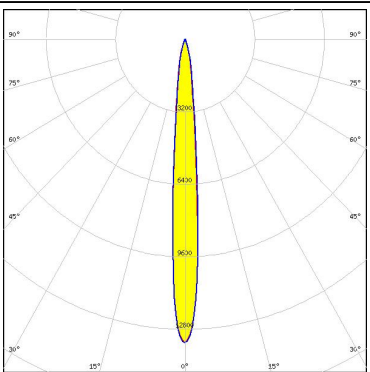
**CREE LEDs**

LED	CXA/B 15xx
FWHM / FWTM	14.0° / 33.0°
Efficiency	75 %
Peak intensity	7.2 cd/lm
LEDs/each optic	1
Light colour	White

Required components:  
BJB: 47.319.6101



### OPTICAL RESULTS (MEASURED):

#### SAMSUNG

LED LC003D / LC006D / LC009D / LC013D  
 FWHM / FWTM 15.0° / 35.0°  
 Efficiency 77 %  
 Peak intensity 6.6 cd/lm  
 LEDs/each optic 1  
 Light colour White  
 Required components:  
 BJB: 47.319.6060

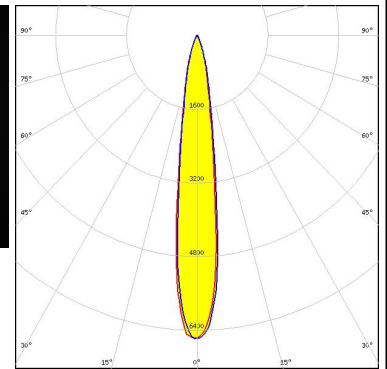

#### SAMSUNG

LED LC003D / LC006D / LC009D / LC013D  
 FWHM / FWTM 15.0° / 35.0°  
 Efficiency 77 %  
 Peak intensity 6.6 cd/lm  
 LEDs/each optic 1  
 Light colour White  
 Required components:  
 A.A.G. STUCCHI: 8100-G2

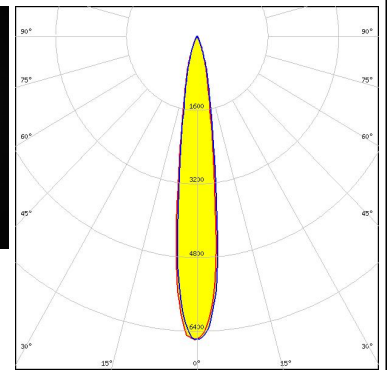

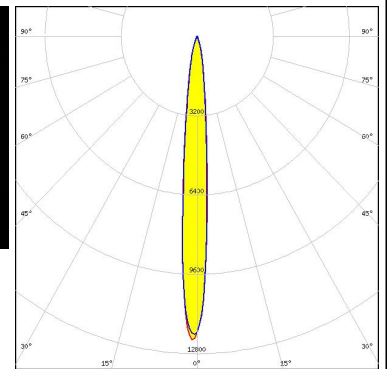
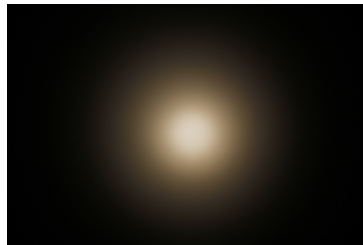

SEOUL SEMICONDUCTOR

LED MJT COB LES 6  
 FWHM / FWTM 10.0° / 25.0°  
 Efficiency 77 %  
 Peak intensity 12.3 cd/lm  
 LEDs/each optic 1  
 Light colour White  
 Required components:  
 BJB: 47.319.6060

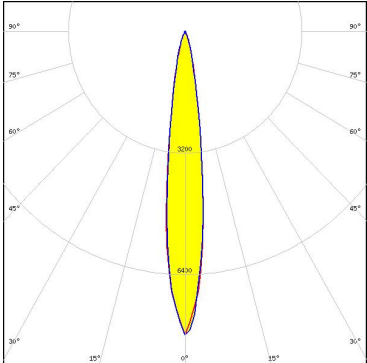
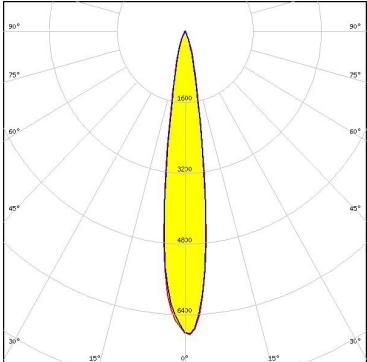
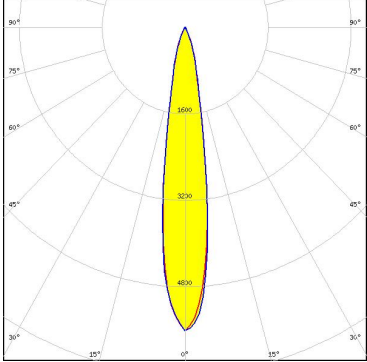

### OPTICAL RESULTS (SIMULATED):

<p> LED V10 Gen6 FWHM / FWTM 14.0° / 30.0° Efficiency 76 % Peak intensity 8 cd/lm LEDs/each optic 1 Light colour White Required components: BJB: 47.319.6214</p>	
<p><b>CITIZEN</b> LED CLL02x/CLU02x (LES10) FWHM / FWTM 16.0° / 32.0° Efficiency 75 % Peak intensity 6.9 cd/lm LEDs/each optic 1 Light colour White Required components: BJB: 47.319.6060</p>	
<p><b>CITIZEN</b> LED CLU720/721/723 FWHM / FWTM 17.0° / 37.0° Efficiency 74 % Peak intensity 5.6 cd/lm LEDs/each optic 1 Light colour White Required components:</p>	
<p> LED COB S-Type (LES 7) FWHM / FWTM 12.0° / 24.0° Efficiency 80 % Peak intensity 11.9 cd/lm LEDs/each optic 1 Light colour White Required components: BJB: 47.319.6180</p>	