

## CARMEN-M-B

~35° medium beam. Assembly with holder B compatible with Ø40 mm BJB and B+W connectors.

### SPECIFICATION:

Dimensions	Ø 69.5 mm
Height	36.3 mm
Fastening	socket
ROHS compliant	yes ⓘ



### MATERIALS:

Component	Type	Material	Colour	Finish
CARMEN-M	Single lens	PMMA	clear	
CARMEN-HLD-B	Holder	PC	black	

### ORDERING INFORMATION:

Component	Type	Qty in box	MOQ	MPQ	Box weight (kg)
CP15215_CARMEN-M-B	Single lens	150	150	15	6.0
» Box size: 476 x 273 x 292 mm					

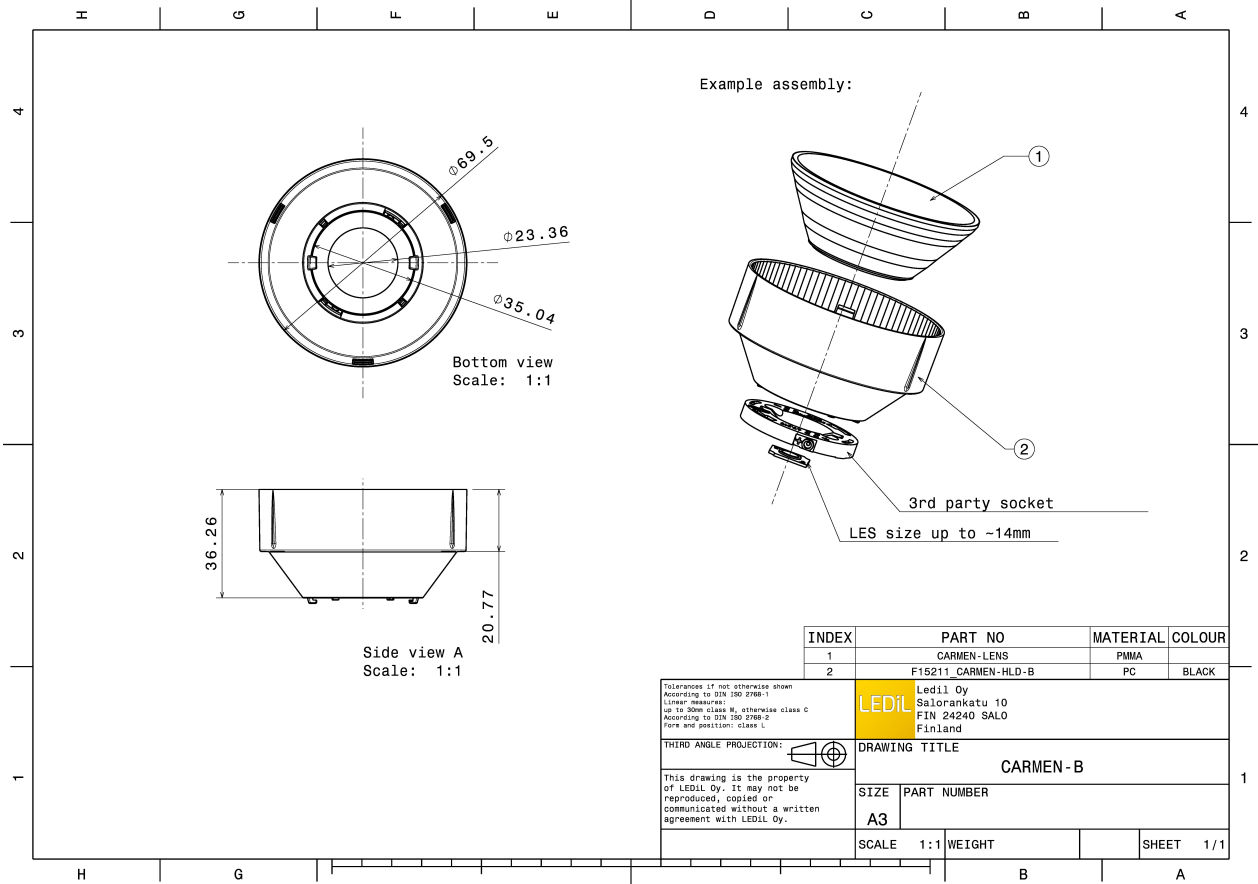

See also our general installation guide: [www.ledil.com/installation\\_guide](http://www.ledil.com/installation_guide)

### OPTICAL RESULTS (MEASURED):



LED V10 Gen7  
 FWHM / FWTM 44.0° / 73.0°  
 Efficiency 73 %  
 Peak intensity 1.2 cd/lm  
 LEDs/each optic 1  
 Light colour White  
 Required components:  
 BJB: 47.319.6060

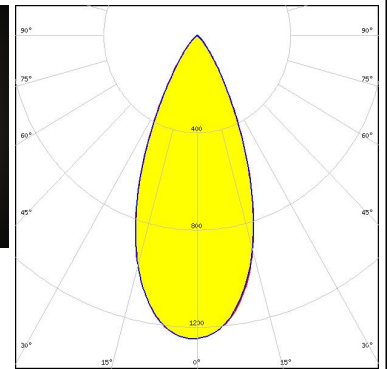
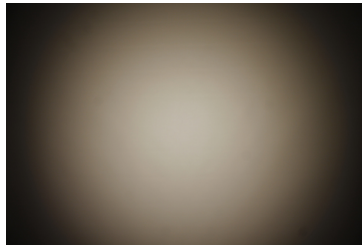

### CITIZEN

LED CLU700/701/702/703  
 FWHM / FWTM 38.0° / 60.0°  
 Efficiency 81 %  
 Peak intensity 1.9 cd/lm  
 LEDs/each optic 1  
 Light colour White  
 Required components:  
 BJB: 47.319.6060

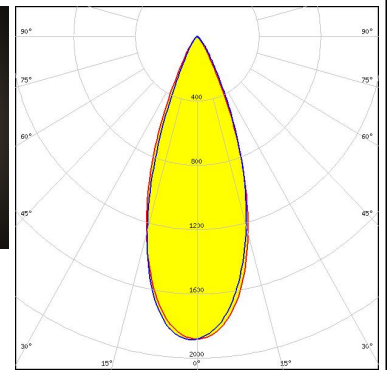
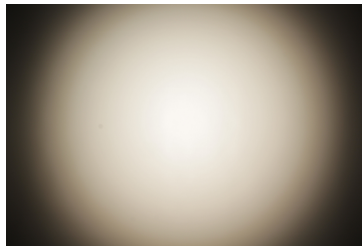

LED CXA/B 13xx  
 FWHM / FWTM 38.0° / 61.0°  
 Efficiency 83 %  
 Peak intensity 1.9 cd/lm  
 LEDs/each optic 1  
 Light colour White  
 Required components:  
 BJB: 47.319.6120

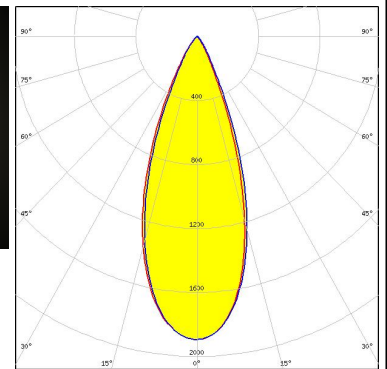
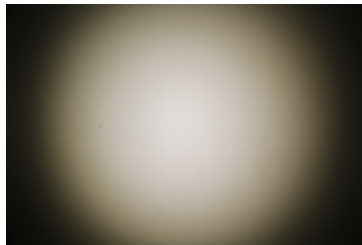

LED CXA/B 15xx  
 FWHM / FWTM 44.0° / 63.0°  
 Efficiency 80 %  
 Peak intensity 1.6 cd/lm  
 LEDs/each optic 1  
 Light colour White  
 Required components:  
 BJB: 47.319.6101

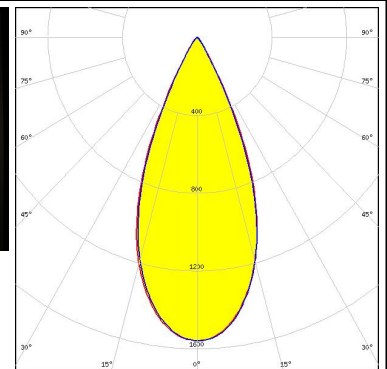
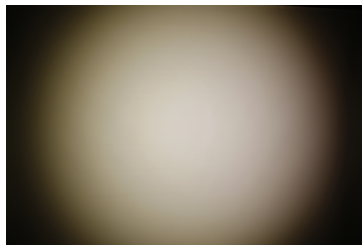

#### OPTICAL RESULTS (MEASURED):

### SAMSUNG

LED LC003D / LC006D / LC009D / LC013D  
 FWHM / FWTM 48.0° / 70.0°  
 Efficiency 76 %  
 Peak intensity 1.2 cd/lm  
 LEDs/each optic 1  
 Light colour White  
 Required components:  
 BJB: 47.319.6060

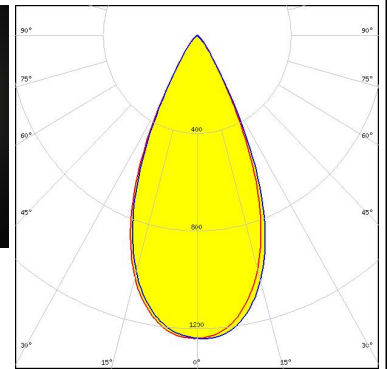
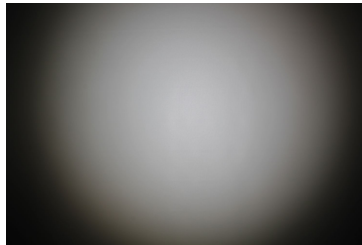

### SAMSUNG

LED LC003D / LC006D / LC009D / LC013D  
 FWHM / FWTM 48.0° / 70.0°  
 Efficiency 76 %  
 Peak intensity 1.2 cd/lm  
 LEDs/each optic 1  
 Light colour White  
 Required components:  
 A.A.G. STUCCHI: 8100-G2

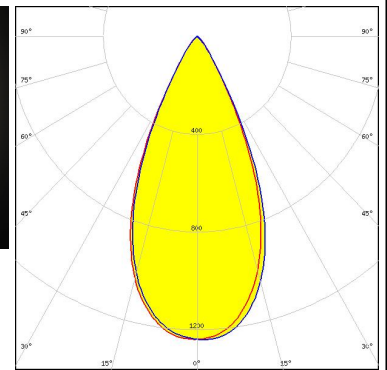
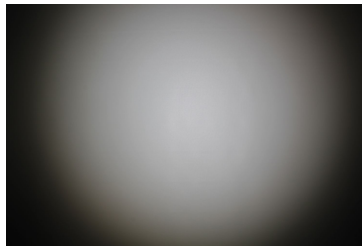

LED MJT COB LES 6  
 FWHM / FWTM 38.0° / 66.0°  
 Efficiency 76 %  
 Peak intensity 1.6 cd/lm  
 LEDs/each optic 1  
 Light colour White  
 Required components:  
 BJB: 47.319.6060

